

We open
doors
in style.



Catalogo prodotti
Product catalogue

lineacalì

Fino a quando le porte non si
apriranno con il pensiero sogneranno
sempre una maniglia Linea Calì.

*As long as the doors will not be
operated telepathically they'll all still
dream of a Linea Calì handle.*

Collezioni / *Collections*

	Pag.
Contemporaneo / <i>Contemporary</i>	37
Classico / <i>Classic</i>	125
Easy	177
Crystal	189
Vintage	259

Accessori / *Accessories*

	Pag.
Maniglioni / <i>Pull handles</i>	322
Maniglioni alzanti / <i>Pull-up handles</i>	333
Pomoli per porte / <i>Door knobs</i>	335
Battenti / <i>Door knockers</i>	340
Bocchette / <i>Escutcheons</i>	341
Bocchette set-wc / <i>Privacy set</i>	344
Chiavi / <i>Keys</i>	347
Campanelli / <i>Bells</i>	347
Fermaporta / <i>Door stops</i>	348
Fermaporta magnetici / <i>Magnetic door stops</i>	349
Appendiabiti / <i>Coat hooks</i>	349
Maniglie e accessori per porte blindate / <i>Handles and accessories for armored doors</i>	350
Placche incasso / <i>Flush pull</i>	352
Placche incasso su placca / <i>Flush pull on plate</i>	353
Kit incasso / <i>Inset handle kit</i>	354
Serie Hotel / <i>Hotel series</i>	355
Copricerniere / <i>Hinge covers</i>	356
Cerniere / <i>Hinges</i>	357
Materiale pubblicitario / <i>Advertising material</i>	358

Accessori per mobile / *Cabinet accessories*

	Pag.
Pomelli per mobile / <i>Cabinet knobs</i>	362
Maniglie per mobile / <i>Cabinet handles</i>	366

Indice collezioni / *Collections index* —

Contemporaneo / *Contemporary*

	Pag.							
	Ala	38		Grip Ebano	66		Sintesi	98
	Aqua	40		Grip Pelle	68		Sintesi Wengè	100
	Cavity	42		Ibis	72		Slim	102
	Duna	44		Jenny	74		Slim Pelle	104
	Dynamic	46		Jet	76		Spirit	108
	Elios	48		Kendo	78		Strip	110
	Elle	50		Komfort	82		Thais	112
	Elle Pelle	52		Living	84		Trendy	114
	Entry	56		Nau	86		Wind	116
	Era	58		Point	88		Zen	118
	Fish	62		Prisma	90		Zen Fusion	120
	Grip	64		Profilo	92		Zen Wengè	122
				Riflesso	94			
				Rombo	96			

Classico / Classic

	Pag.
	Aldar 126
	Aria 128
	Beta 130
	Dafne 132
	Dalia 134
	Delfino 138
	Elika 140
	Erica 142
	Flavia 144
	Florenzia 146
	Havana 148



Heidi 150



Karina 152



Kuba 154



Kuba pomolo 156



Lady 158



Libera 160



Marina 162



Nota 164



Pin-up 166



Rose 168



Tess 172





























Tosca 174





























Easy

	Pag.
	Brixia 178
	Garda 180
	Ibiza 182
	Onda 184
	Piuma 186

Crystal

	Pag.				
		Jewel	216		Sogno 246
		Led Mesh	220		Spirit Mesh 248
	190	Brilliant Crystal	190		Luce 222
	192	Brilliant Diamond	192		Nau Crystal 226
	194	Cosmic	194		Ninfa Crystal 228
	196	Crystal	196		Opera Crystal 230
	198	Elika Crystal	198		Point Crystal 232
	200	Elios Crystal	200		Profilo Mesh 234
	204	Feeling	204		Reflex 236
	206	Fish Crystal	206		Riflesso Mesh 238
	208	Flory	208		Riflesso Rocks 240
	212	Havana Mesh	212		Shell Mesh 242
	214	Idea Crystal	214		Sintesi Mesh 244

Vintage

	Pag.				
	Aida	260		Frida	282
	Aisha	262		Glamor	284
	Arcadia	266		Jardin	286
	Arte	268		Jewel	216
	Barocco	270		Liberty	290
	Brilliant Crystal	190		Nature	294
	Brilliant Diamond	192		Ninfa	296
	Charme	272		Ninfa Porcellana	298
	Chic	274		Ninfa Crystal	228
	Daisy	276		Opera	300
	Epoca	280		Opera Crystal	230
				Poesia	304
				Queen	306
				Rococò	310
				Sissi	312
				Soleil	314
				Tiffany	316
				Tiffany Mesh	250
				Zaara	318

Indice alfabetico / *Alphabetical index* —

	Pag.				
Aida	260	Erica	142	Luce	222
Aisha	262	Feeling	204	Marina	162
Ala	38	Fish	62	Nature	294
Aldar	126	Fish Crystal	206	Nau	86
Aqua	40	Flavia	144	Nau Crystal	226
Arcadia	266	Florenzia	146	Ninfa	296
Aria	128	Flory	208	Ninfa Crystal	228
Arte	268	Frida	282	Ninfa Porcellana	298
Barocco	270	Garda	180	Nota	164
Beta	130	Glamor	284	Onda	184
Brilliant Crystal	190	Grip	64	Opera	300
Brilliant Diamond	192	Grip Ebano	66	Opera Crystal	230
Brixia	178	Grip Pelle	68	Pin-up	166
Cavity	42	Havana	148	Piuma	186
Charme	272	Havana Mesh	212	Poesia	304
Chic	274	Heidi	150	Point	88
Cosmic	194	Ibis	72	Point Crystal	232
Crystal	196	Ibiza	182	Prisma	90
Dafne	132	Idea Crystal	214	Profilo	92
Daisy	276	Jardin	286	Profilo Mesh	234
Dalia	134	Jenny	74	Queen	306
Delfino	138	Jet	76	Reflex	236
Duna	44	Jewel	216	Riflesso	94
Dynamic	46	Karina	152	Riflesso Mesh	238
Elika	140	Kendo	78	Riflesso Rocks	240
Elika Crystal	198	Komfort	82	Rococò	310
Elios	48	Kuba	154	Rombo	96
Elios Crystal	200	Kuba pomolo	156	Rose	168
Elle	50	Lady	158	Shell Mesh	242
Elle Pelle	52	Led Mesh	220	Sintesi	98
Entry	56	Libera	160	Sintesi Mesh	244
Epoca	280	Liberty	290	Sintesi Wengè	100
Era	58	Living	84	Sissi	312

Slim	102
Slim Pelle	104
Sogno	246
Soleil	314
Spirit	108
Spirit Mesh	248
Strip	110
Tess	172
Thais	112
Tiffany	316
Tiffany Mesh	250
Tosca	174
Trendy	114
Veronica	252
Wind	116
Zaara	318
Zen	118
Zen Fusion	120
Zen Mesh	254
Zen Wengè	122

Finiture / *Finishes* _____



BA | Bianco lucido / *Glossy white*



BT | Cromo satinato + bianco lucido / *Satin chrome + glossy white*



CZ | Cromo lucido + oro zecchino / *Polished chrome + gold plated*



CR | Cromo lucido / *Polished chrome*



CC | Cromo satinato + cromo lucido / *Satin chrome + polished chrome*



ZC | Oro zecchino + cromo lucido / *Gold plated + polished chrome*



CS | Cromo satinato / *Satin chrome*



CM / MC | Cromo lucido + cromo sabbato / *Polished chrome + matt chrome*



MO / OM | Oro sabbato + oro / *Matt gold + polished gold*



AS | Antracite satinato / *Satin anthracite*



RS | Cromo lucido + cromo satinato / *Polished chrome + satin chrome*



AG | Antracite satinato + oro zecchino / *Satin anthracite + gold plated*



VE | Nero opaco / *Matt black*



CN | Cromo lucido + nickel satinato / *Polished chrome + satin nickel*

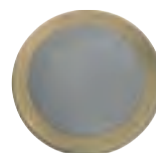

AM | Antracite satinato + patiné / *Satin anthracite + patiné mat*



NL | Nickel lucido / *Polished nickel*



AC | Antracite satinato + cromo lucido / *Satin anthracite + polished chrome*



ZO | Nero opaco + oro zecchino / *Matt black + gold plated*



NS | Nickel satinato / *Satin nickel*



SE | Cromo satinato + nero opaco / *Satin chrome + matt black*



OT | Ottone satinato + ottone lucido / *Satin brass + polished brass*



BL | Cromo lucido + bianco lucido / *Polished chrome + glossy white*



CE | Cromo lucido + nero opaco / *Polished chrome + matt black*



OZ | Oro zecchino / *Gold plated*



OL | Ottone lucido
verniciato / *Polished brass*



OS | Ottone satinato /
Satin brass



PV | Titanio / *Titanium*



VB | Ottone vibrato /
Vibrated brass



OG | Ottone bronzato
graffiato / *Bronzed brass*



PM | Patiné / *Patiné mat*



FV | Ferro effetto
invecchiato / *Aged iron
(brass)*



AN | Ottone invecchiato /
Aged brass



BO | Bronzo sfumato
opaco / *Bronze*



OB | Ottone bronzato
satinato / *Bronzed brass +
satin brass*



BM | Bronzo opaco / *Matt
bronze*



NF | Nero francese / *French
black*



AA | Argento antico opaco
/ *Antique silver*



TM | Peltro / *Pewter*



VN | Nero opaco + nero
francese / *Matt black +
french black*



OF | Oro francese / *French
gold*



OO | Ottone opaco / *Matt
brass*



NP | Bronzo opaco + patiné
/ *Matt bronze + patiné mat*

Azienda / *Company* —





Il fascino dello stile italiano si racconta nella nostra storia —

La differenza tra una maniglia e un semplice pezzo di ottone nasce nel 1986, quando Paolo e Danilo Cali, insieme a Mario Facchetti, fondarono la Linea Cali srl e iniziarono a trasformare delle semplici maniglie in ottone in complementi di arredo a tutti gli effetti.

Un'idea rischiosa ma lungimirante, che rivoluzionò il mondo della maniglieria e le permise di diventare una delle aziende di riferimento nella produzione di "maniglie di stile".

A oltre 35 anni dalla sua fondazione, Linea Cali continua a produrre in Italia seguendo la stessa filosofia, distinguendosi dalla concorrenza e rappresentando nel mondo il simbolo del lusso Made in Italy.

Ora l'azienda guarda al futuro con entusiasmo e fiducia, perché fino a quando le porte non si apriranno con il pensiero... sogneranno sempre una maniglia Linea Cali.

The difference between a handle and a simple piece of brass was born in 1986, when Paolo and Danilo Cali, together with Mario Facchetti, founded the Linea Cali srl and began to transform simple brass handles into furnishing accessories for all purposes.

A risky but far-sighted idea, which revolutionized the world of handles and allowed it to become one of the leading companies in the production of "style handles".

More than 35 years after its foundation, Linea Cali continues to produce in Italy following the same philosophy, distinguishing itself from the competition and representing the symbol of Made in Italy luxury in the world.

Now the company looks to the future with enthusiasm and trust, because as long as the doors will not be operated telepathically... they'll all still dream of a Linea Cali handle.



Mario Facchetti, Paolo e Danilo Cali.

La nostra storia in 8 maniglie —

1986

Fondazione e
inaugurazione
stabilimento di Vobarno.

*Foundation and
inauguration of the
Vobarno plant.*

1992

Lancio della prima
collezione di maniglie
con cristalli originali
Swarovski®.

*Launch of the first
collection of handles
embellished with original
Swarovski® crystals.*

1989

Produzione della
milionesima maniglia.

*Production of the millionth
handle.*

1998

Trasferimento e
inaugurazione della nuova
sede a Carpeneda di
Vobarno.

*Transfer and inauguration
of the new headquarters in
Carpeneda di Vobarno.*



Luna



Dalia



Crystal



Kuba

2005

Produzione della prima maniglia Vintage.

Production of the first Vintage handle.

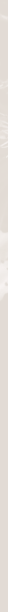

2018

Ampliamento sede e apertura nuovo showroom.

Extension of the headquarters and opening of new showroom.



2015

Ampliamento del magazzino (900 mq coperti).

Extension of the warehouse (900 covered sq m).



2022

Rebranding (nuovo marchio e immagine coordinata).

Rebranding (new brand and coordinated image).

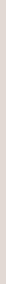

Opera



Nau



Glamor



Entry

Showroom —







Linea Cali è pronta a ricevervi nel nuovo showroom, un openspace di oltre 130 mq che occupa il terzo piano della palazzina direzionale.

Il nuovo allestimento segue l'evoluzione dell'azienda che si rivolge sempre più a un pubblico ricercato e sofisticato.

Per prenotare una visita potete scrivere a info@lineacali.it.

Linea Cali is ready to welcome you to its new showroom, an open space of over 130 square meters that occupies the third floor of the executive building.

This new appointment follows the evolution of the company, which is increasingly aimed at a more refined and sophisticated target market.

To book a visit you can contact us at info@lineacali.it.



Produciamo maniglie, in Italia —



Linea Cali è orgogliosa di garantire la produzione italiana di tutti i prodotti nel rispetto delle più recenti normative Europee.

A riprova di ciò ogni articolo che supera con esito positivo i numerosi test di laboratorio, viene "firmato" con il marchio Linea Cali che ne attesta l'autenticità, garantendo così al cliente l'acquisto di una maniglia di alta qualità interamente prodotta in Italia.

Linea Cali is proud to guarantee the Italian production of all its products in compliance with the recent European regulations.

As proof of this, each item that successfully passes numerous laboratory tests is "signed" with the Linea Cali brand which certifies its authenticity, thus guaranteeing the customer the purchase of a high quality handle entirely produced in Italy.

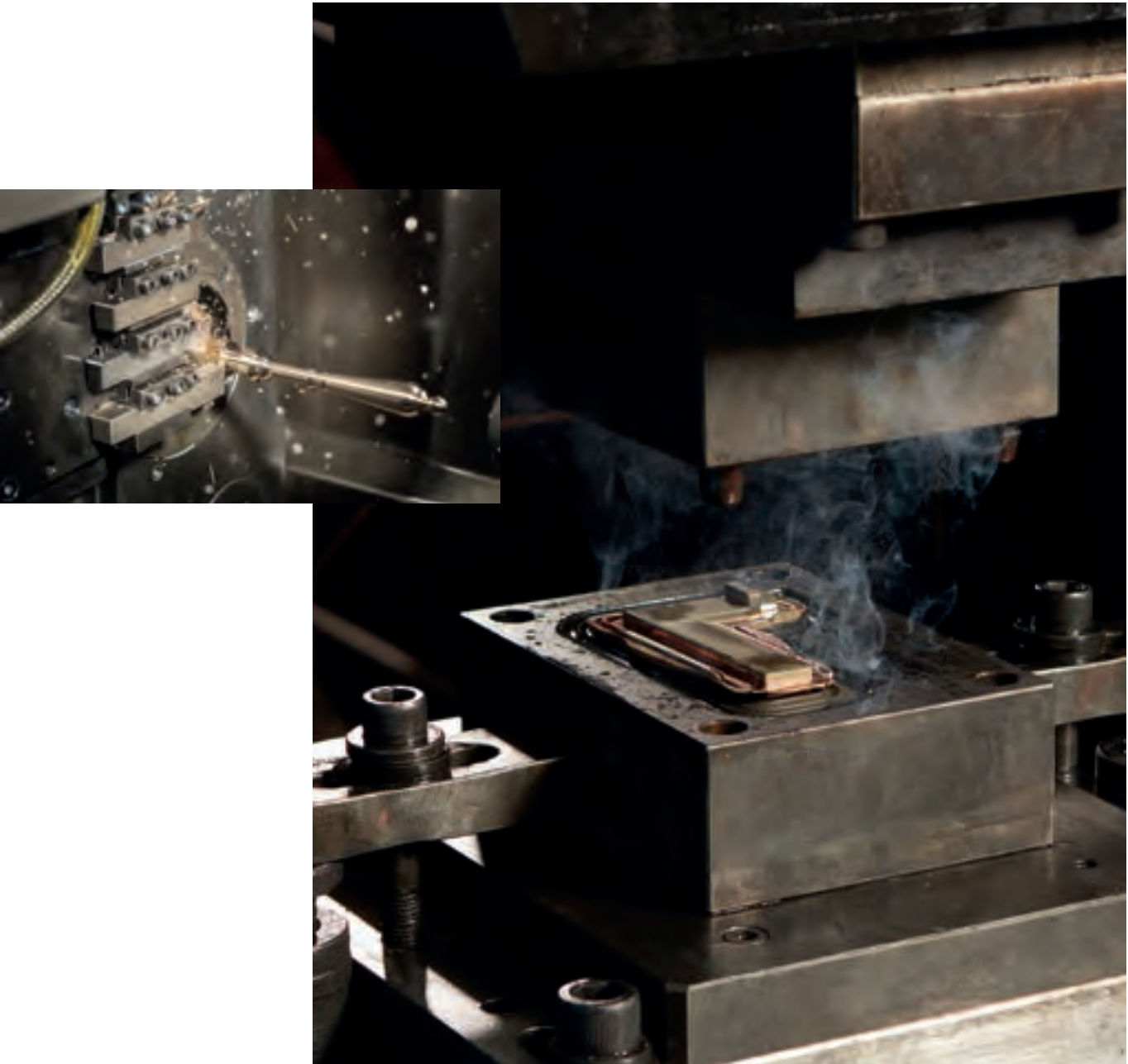



Prodotti di qualità che resistono alle mode e al tempo che passa —

Linea Cali ha ottenuto la certificazione EN 1906:2012, la norma europea che classifica maniglie per porte e finestre assegnando precisi indicatori di qualità.

Sottoposte a test dalla durata ininterrotta di 240 ore e a oltre 100.000 cicli di prova, le maniglie di Linea Cali sono risultate estremamente resistenti alla corrosione e con prestazioni garantite per lunghi anni:

- 5 anni per le finiture cromo lucido o cromo satinato;
- 10 anni se trattate con procedimento PVD.

Per quanto riguarda la resistenza alla corrosione, le maniglie della Linea Cali si sono posizionate sul più alto gradino della scala di valore: la Classe 4.

Linea Cali has obtained the EN 1906:2012 certification, the European standard that classifies door and window handles by assigning precise quality indicators.

Tested for an uninterrupted duration of 240 hours and over 100,000 cycles, the Linea Cali handles are extremely resistant to corrosion and with guaranteed performance for many years:

- *5 years for the polished chrome and satin chrome finishes;*
- *10 years if treated with PVD procedure.*

With regard to corrosion resistance, the Linea Cali handles were positioned on the highest step of the value scale: Class 4.

Sistema di bloccaggio ultrarapido Click-Clack —

L'innovativo sistema Click-Clack mette al riparo da danni e situazioni spiacevoli impedendo alla maniglia di sfilarsi qualora il grano di fissaggio dovesse allentarsi col tempo.

Per far scattare il sistema di bloccaggio basta semplicemente infilare l'impugnatura sul ferro quadro. Per rimuoverla, dopo aver allentato il grano di fissaggio, basta premere sul tastino situato nella parte inferiore della rosetta.

Il sistema Click-Clack è inoltre una dimostrazione dell'impegno che Linea Cali dedica per garantire ai suoi clienti affidabilità e sicurezza.

The innovative Click-Clack system protects against damage and unpleasant situations, preventing the handle from coming off if the fixing scrub loosens over time.

To trigger the locking system, simply insert the handle onto the square iron. To remove it, after loosening the fixing grub screw, simply press on the knob located at the bottom of the rose.

The Click-Clack system is also a demonstration of the commitment that Linea Cali dedicates to guaranteeing its customers reliability and safety.



CLACK!

CLICK!



Sistema invisibile anti intrusione SmartBlock —

Capita sempre più di frequente che i ladri entrino nelle abitazioni praticando un foro nei serramenti e facendo leva sulla maniglia con un attrezzo particolare (ferro dalla punta girevole).

Con SmartBlock questo è impossibile perché il sistema invisibile blocca la maniglia impedendo ai ladri di entrare.

Affidabile e sicuro perché costruito senza componenti meccaniche che potrebbero usurarsi, si aziona in automatico ogni volta che si chiude la finestra o si mette nella posizione a ribalta (vasistas).

It happens more and more frequently that thieves enter homes by drilling a hole in the window frames and leveraging the handle with a special tool (iron with a swivel tip).

With SmartBlock this is impossible because the invisible system locks the handle preventing thieves from entering.

Reliable and safe because it is built without mechanical components that could wear out, it is operated automatically every time you close the window or put it in the tilting position.

Oggetti del desiderio che brillano in ogni ambiente —



Grazie all'esperienza pluriennale nel mondo del lusso, Linea Cali è stata una delle prime aziende al mondo a percepire la necessità di caratterizzare le abitazioni con complementi di arredo sempre più particolari ed esclusivi.

Iniziò così a trasformare un oggetto di uso comune, la maniglia, in un gioiello prezioso dalle mille sfaccettature impreziosendola con cristalli Swarovski®.

Oggi, dopo oltre 25 anni dal lancio del primo modello, le collezioni Crystal di Linea Cali risplendono negli ambienti più esclusivi rappresentando l'emblema del lusso contemporaneo.

Thanks to its many years of experience in the world of luxury, Linea Cali was one of the first companies in the world to perceive the need to characterize homes with increasingly special and exclusive furnishing accessories.

He thus began to transform an everyday object, the handle, into a precious jewel with a thousand facets embellishing it with Swarovski® crystals.

Today, more than 25 years after the launch of the first model, the Linea Cali Crystal collections shine in the most exclusive environments, representing the emblem of contemporary luxury.



SWAROVSKI

Certificate

Swarovski Ignites Dreams since 1895 with the finest crystal embellishments. Available in a myriad of colors, effects, shapes and sizes, crystals from Swarovski offer designers a fabulous palette of inspiration. Our Ingredient Branding solution, by granting the usage of our iconic seal, provides a world class branding solution to our top-tier customers.

LINEA CALI'

meets the standards set by Swarovski for its exclusive Ingredient Branding Partners and has therefore been approved as an Ingredient Branding Partner.

As provided in the Crystals from Swarovski Ingredient Brand Logo Licence Agreement, Ingredient Branding Partners are permitted to use the distinctive Swarovski seal depicted below on products, product packaging and in communication materials, for their products sold under the brand.

LINEA CALI'

and embellished with 100% genuine Swarovski crystals



Priloženo je potvrđeno da su kristali iz ovog proizvoda 100% originalni i potpuno su izrađeni od kristala iz tvornice Swarovski. Ovo potvrđuje da su kristali iz ovog proizvoda 100% originalni i potpuno su izrađeni od kristala iz tvornice Swarovski.

Milan, July 15th 2022

July 14th 2023

Date and Place of Issue

Expiry Date

D. Škarnički Distribution Centre

SEAL.CRYSTALS-FROM-SWAROVSKI.COM

© 2023 D. Škarnički Distribution Centre. Swarovski® is a registered trademark of Swarovski AG.

Linea Cali è una delle poche aziende al mondo a essere in possesso del certificato Swarovski® che le conferisce il titolo di Ingredient Branding Partners.

Ogni collezione di maniglie per porte e finestre, maniglioni e accessori, impreziosite da cristalli originali Swarovski® viene accompagnata da un codice grazie al quale è possibile verificarne facilmente l'autenticità.

Linea Cali is one of the few companies in the world to be in possession of the Swarovski® certificate giving it the title of Ingredient Branding Partners.

Each collection of door and window handles, pull handles and accessories, embellished with original Swarovski® crystals, is accompanied by a code that makes it easy to verify their authenticity.



Codice identificativo /
Identification code

Contemporaneo
Contemporary



Ala _



La mano scivola sul dorso della maniglia come il vento sulle ali di un aeroplano, ma il design consapevole dona una presa estremamente solida, confortevole e sicura.

Your hand glides over the handle like the wind on the wings of an airplane, but the conscious design results in an extremely solid, comfortable and secure grip.

Finiture / Finishes



CR | Cromo lucido /
Polished chrome



CS | Cromo satinato /
Satin chrome



VE | Nero opaco / Matt
black

Collezione / Collection

1385 RB 019
Maniglia con rosetta
art.019 / Door handle
on rose art.019

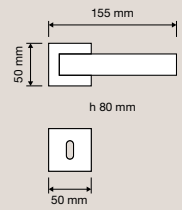

1385 RB 024
Maniglia con rosetta
art.024 / Door
handle on rose
art.024

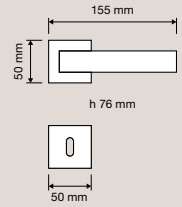

1385 PL
Maniglia con placca /
Door handle on plate

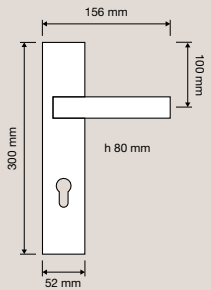

1385 DK
Maniglia per finestra
con movimento DK 4
posizioni / Window
handle with DK
movement 4 clicks

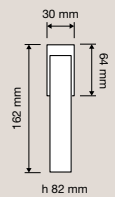

1385 SK
Maniglia per finestra
con movimento
DK SmartBlock /
Window handle
with DK SmartBlock
movement

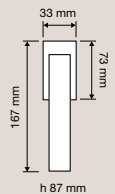

Aqua —



I motivi che la risacca del mare disegna sulla battigia caratterizzano l'inusuale forma di questa collezione dal design moderno ed evocativo.

The patterns that the sea's tide leave on the water's edge characterise the unusual form of this collection with a modern and evocative design.

Collezione / Collection

Finiture / Finishes



BM | Bronzo opaco /
Matt bronze



CR | Cromo lucido /
Polished chrome



CS | Cromo satinato /
Satin chrome



OZ | Oro zecchino /
Gold plated

1440 RB 019
Maniglia con rosetta
art.019 / Door handle
on rose art.019

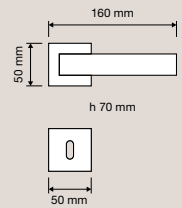

1440 RB 024
Maniglia con rosetta
art.024 / Door
handle on rose
art.024

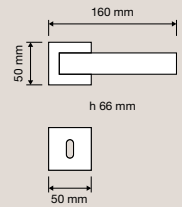

1440 PL
Maniglia con placca /
Door handle on plate

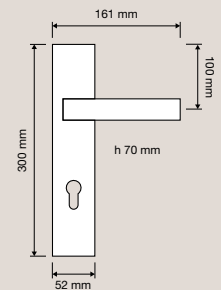

1440 DK
Maniglia per finestra
con movimento DK 4
posizioni / Window
handle with DK
movement 4 clicks

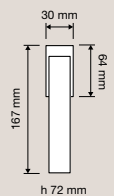

1440 SK
Maniglia per finestra
con movimento
DK SmartBlock /
Window handle
with DK SmartBlock
movement

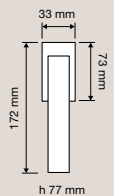

Cavity



Finiture / Finishes



BL | Cromo lucido + bianco lucido / *Polished chrome + glossy white*



BT | Cromo satinato + bianco lucido / *Satin chrome + glossy white*



CC | Cromo satinato + cromo lucido / *Satin chrome + polished chrome*



CE | Cromo lucido + nero opaco / *Polished chrome + matt black*



CN | Cromo lucido + nickel satinato / *Polished chrome + satin nickel*



RS | Cromo lucido + cromo satinato / *Polished chrome + satin chrome*



SE | Cromo satinato + nero opaco / *Satin chrome + matt black*

Due profili circolari di ottone si incontrano per dar vita a una maniglia contraddistinta da un inserto forato che lascia intravedere la sua anima.

Two circular brass profiles meet to give life to a handle characterized by a perforated insert that reveals its soul.

Collezione / Collection

1726 RB 025
Maniglia con rosetta
art.025 / Door
handle on rose
art.025

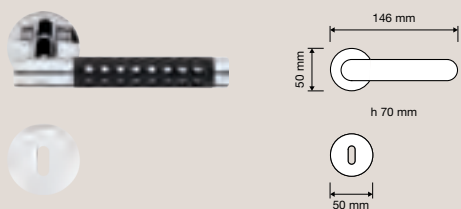

1726 MN 300
Maniglione / Pull
handle

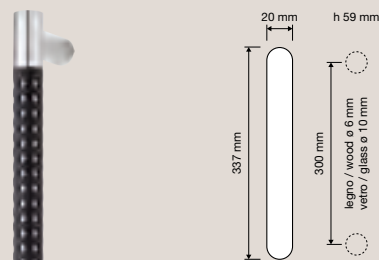

1726 PL
Maniglia con placca
art.123 / Door handle
on plate art.123

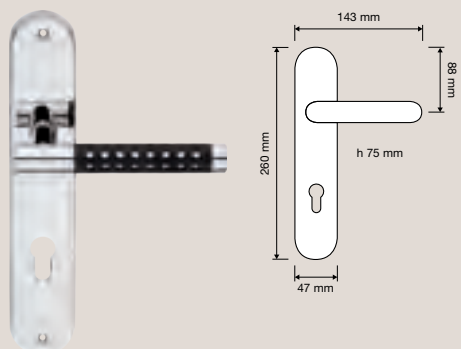

1726 DK
Maniglia per finestra
con movimento DK 4
posizioni / Window
handle with DK
movement 4 clicks

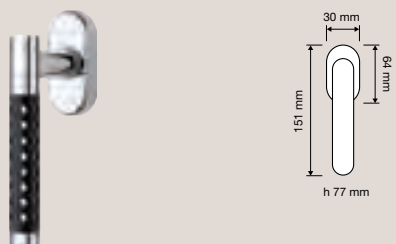

1726 SK
Maniglia per finestra
con movimento
DK SmartBlock /
Window handle
with DK SmartBlock
movement

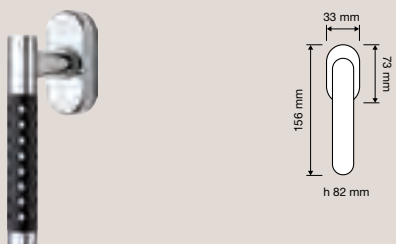

Duna



Finiture / Finishes



BM | Bronzo opaco /
Matt bronze



CR | Cromo lucido /
Polished chrome



CS | Cromo satinato /
Satin chrome



OZ | Oro zecchino /
Gold plated

Plasmata dalla forza del vento,
esprime la sensazione di mistero e
maestosità del deserto.

*Shaped by the force of the wind, it
conveys the sensation of mystery and
majesty of the desert.*

Collezione / Collection

1410 RB 019
Maniglia con rosetta
art.019 / Door handle
on rose art.019

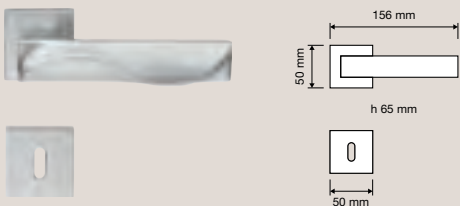

1410 RB 023
Maniglia con rosetta
art.023 / Door
handle on rose
art.023

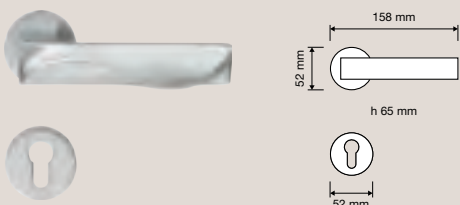

1410 RB 024
Maniglia con rosetta
art.024 / Door
handle on rose
art.024

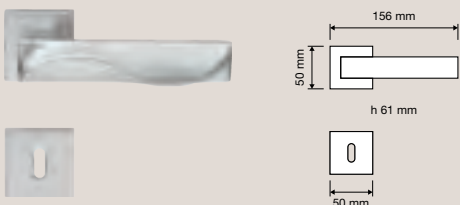

1410 RB 025
Maniglia con rosetta
art.025 / Door
handle on rose
art.025

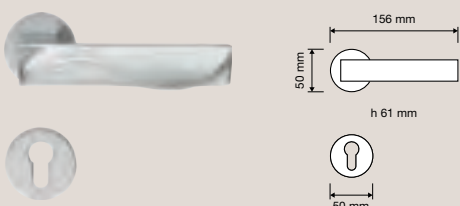

1410 PL
Maniglia con placca /
Door handle on plate

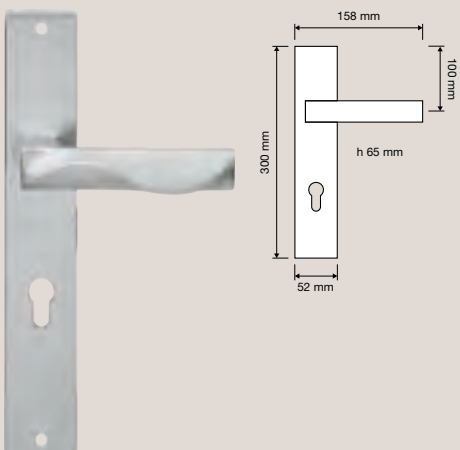

1410 DK
Maniglia per finestra
con movimento DK 4
posizioni / Window
handle with DK
movement 4 clicks

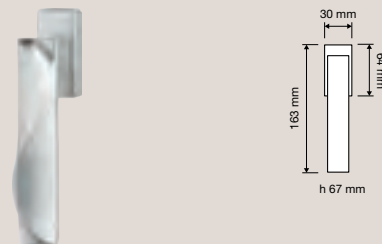

1410 SK
Maniglia per finestra
con movimento
DK SmartBlock /
Window handle
with DK SmartBlock
movement



Dynamic



Finiture / Finishes



BM | Bronzo opaco /
Matt bronze



CR | Cromo lucido /
Polished chrome



CS | Cromo satinato /
Satin chrome



OZ | Oro zecchino /
Gold plated



PM | Patiné / Patiné
mat

Un motivo 3D a onde definisce
l'impugnatura di questa maniglia
dialogando con i volumi squadrati che
lo contengono.

*A 3D wave pattern defines
the handgrip of this handle
communicating with the squared
volumes that contain it.*

Collezione / Collection

1645 RB 019
Maniglia con rosetta
art.019 / Door handle
on rose art.019

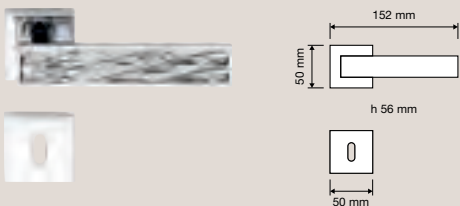

1645 RB 023
Maniglia con rosetta
art.023 / Door
handle on rose
art.023

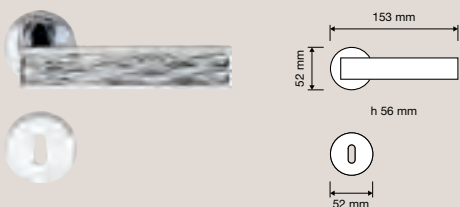

1645 RB 024
Maniglia con rosetta
art.024 / Door
handle on rose
art.024

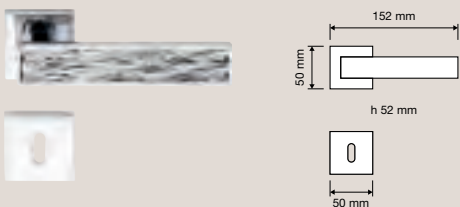

1645 RB 025
Maniglia con rosetta
art.025 / Door
handle on rose
art.025

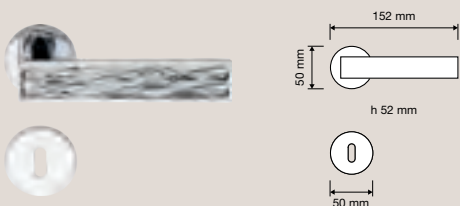

1645 PL
Maniglia con placca /
Door handle on plate

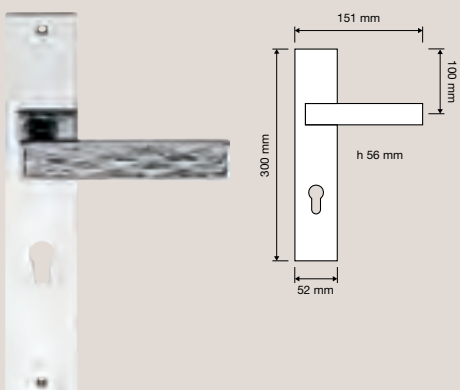

1645 DK
Maniglia per finestra
con movimento DK 4
posizioni / Window
handle with DK
movement 4 clicks

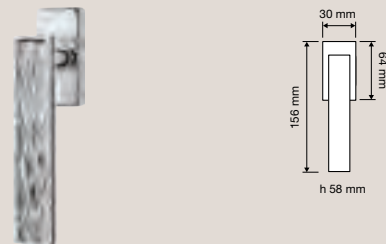

1645 SK
Maniglia per finestra
con movimento
DK SmartBlock /
Window handle
with DK SmartBlock
movement



Elios —



Una collezione sofisticata contraddistinta da una “doppia personalità” che cambia in funzione del punto di vista; moderna ma classica, importante ma sottile e raffinata.

A sophisticated collection characterized by a “dual personality” that changes according to the point of view; modern but classic, important but slender and refined.

Collezione / Collection

Finiture / Finishes



CM | Cromo lucido
+ cromo sabbato /
*Polished chrome +
matt chrome*



CR | Cromo lucido /
Polished chrome



CS | Cromo satinato /
Satin chrome



MO | Oro sabbato
+ oro / *Matt gold +
polished gold*



OZ | Oro zecchino /
Gold plated

1341 RB 019
Maniglia con rosetta
art.019 / *Door handle
on rose art.019*

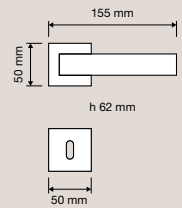
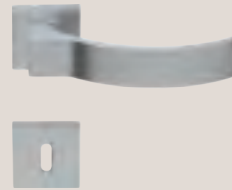

1341 RB 024
Maniglia con rosetta
art.024 / *Door
handle on rose
art.024*

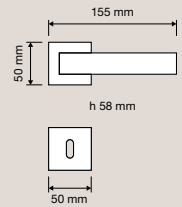

1341 PL
Maniglia con placca /
Door handle on plate

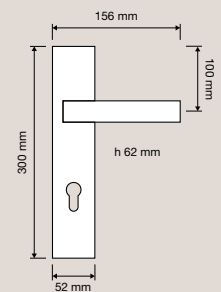

1341 DK
Maniglia per finestra
con movimento DK 4
posizioni / *Window
handle with DK
movement 4 clicks*

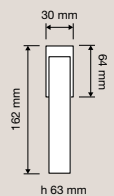

1341 SK
Maniglia per finestra
con movimento
DK SmartBlock /
*Window handle
with DK SmartBlock
movement*

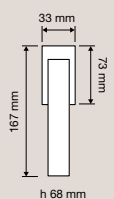



Finiture / Finishes



CC | Cromo satinato +
Cromo lucido / *Satin
chrome + polished
chrome*



CR | Cromo lucido /
Polished chrome



CS | Cromo satinato /
Satin chrome



OT | Ottone satinato
+ ottone lucido
(non disponibile per
maniglie con rosetta
art.019 e art.024) /
*Satin brass + polished
brass (not available for
door handles on rose
art.019 and art.024)*

L'unione di più elementi differenti fra loro, tondi e quadri, dà vita a una collezione sofisticata e semplice al tempo stesso.

The combination of several different elements, round and square, gives life to a sophisticated but at the same time simple collection.

Collezione / Collection

1050 RB 019
Maniglia con rosetta
art.019 / Door handle
on rose art.019

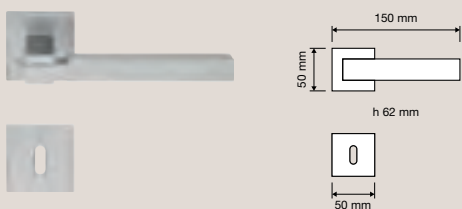

1050 RB 024
Maniglia con rosetta
art.024 / Door
handle on rose
art.024

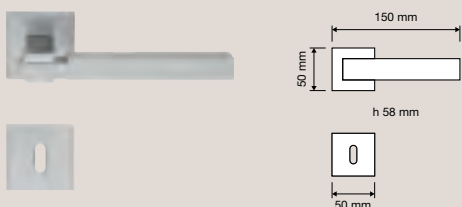

1050 RB 088
Maniglia con rosetta
art.088 / Door
handle on rose
art.088

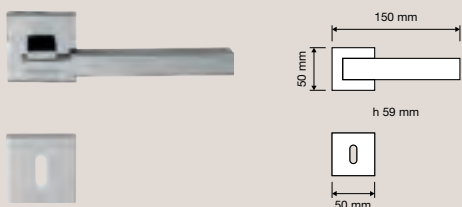

1050 RB 102
Maniglia con rosetta
art.102 / Door handle
on rose art.102

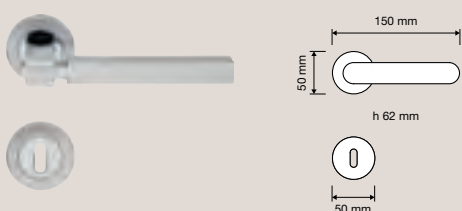

1048 PL
Maniglia con placca /
Door handle on plate

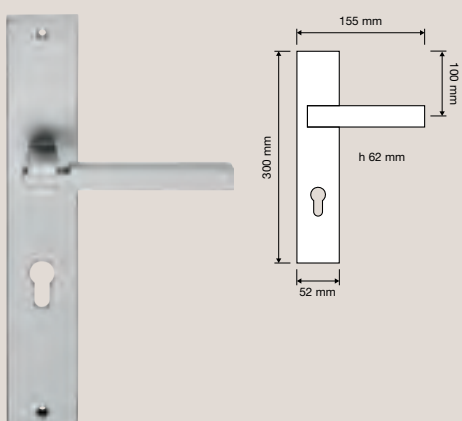

1050 DK
Maniglia per finestra
con movimento DK 4
posizioni / Window
handle with DK
movement 4 clicks

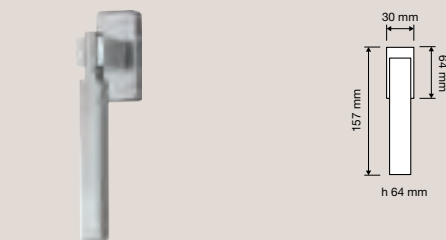

1050 SK
Maniglia per finestra
con movimento
DK SmartBlock /
Window handle
with DK SmartBlock
movement

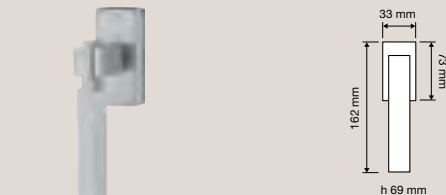

1050 MN 240
Maniglione. Interassi
disponibili 240-320-
440-500-800. / Pull
handle. Available
distances 240-320-
440-500-800.

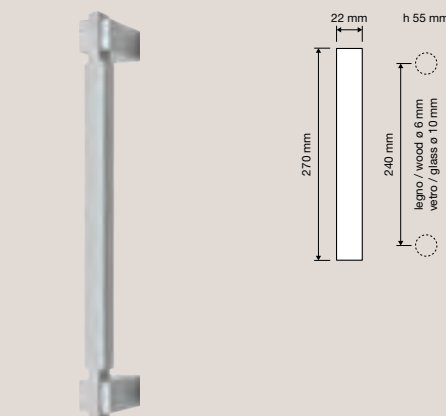

1050 MZ 240
Maniglione zancato.
Interassi disponibili
240-320-440-500-
800. / Offset pull
handle. Available
distances 240-320-
440-500-800.

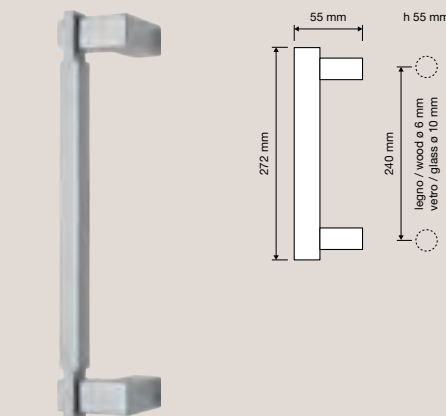

1050 CH
Chiave / Door key



Elle Pelle _



La tradizione italiana della lavorazione artistica del pellame dona una presa estremamente piacevole, morbida e lussuosa, a una collezione che si distingue per il design sofisticato e semplice al tempo stesso.

The Italian tradition of the artistic working of leather gives an extremely pleasant, soft and luxurious grasp to a collection that stands out for its sophisticated yet simple design..

Collezione / Collection

Finiture / Finishes



CR | Cromo lucido /
Polished chrome



CS | Cromo satinato /
Satin chrome



OL | Ottone lucido
verniciato (non
disponibile per
maniglie con rosetta
art.019 e art.024) /
Polished brass (not
available for door
handles on rose
art.019 and art.024)

Pelle / Leather

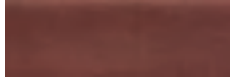

1051 | Marrone / *Brown*

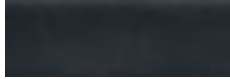

1052 | Nera / *Black*

1052 RB 019
Maniglia con rosetta
art.019 / *Door handle
on rose art.019*

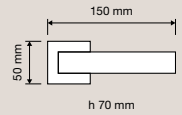

1052 RB 024
Maniglia con rosetta
art.024 / *Door
handle on rose
art.024*

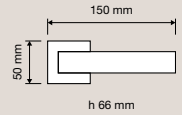
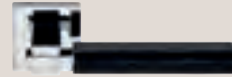

1052 RB 088
Maniglia con rosetta
art.088 / *Door
handle on rose
art.088*

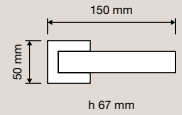

1052 RB 102
Maniglia con rosetta
art.102 / *Door handle
on rose art.102*

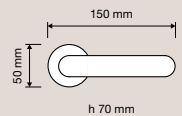

1052 PL
Maniglia con placca /
Door handle on plate

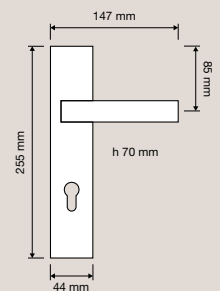

Collezione / Collection

1052 DK
 Maniglia per finestra
 con movimento DK 4
 posizioni / *Window
 handle with DK
 movement 4 clicks*

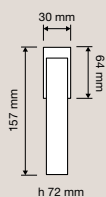

1052 SK
 Maniglia per finestra
 con movimento
 DK SmartBlock /
*Window handle /
 with DK SmartBlock
 movement*

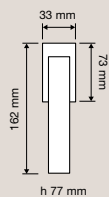

1052 MN 240
 Maniglione / *Pull
 handle*

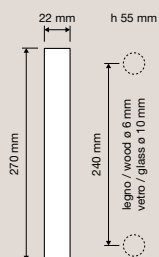

1052 MZ 240
 Maniglione zancato /
Offset pull handle

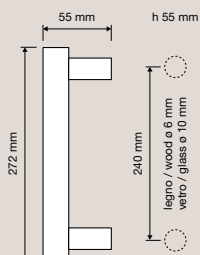



Entry —



Lo studio della funzionalità si traduce in questa collezione che unisce la praticità di un pomolo alla bellezza di una maniglia.

The study of functionality results in this collection of handles that combines the practicality of a knob with the beauty of a handle.

Collezione / Collection

Finiture / Finishes



CR | Cromo lucido /
Polished chrome



CS | Cromo satinato /
Satin chrome



OL | Ottone lucido
verniciato / Polished
brass



OS | Ottone satinato /
Satin brass



PM | Patiné / Patiné
mat



PV | Titanio / Titanium



VE | Nero opaco / Matt
black

1625 RB 019
Maniglia con rosetta
art.019 / Door handle
on rose art.019

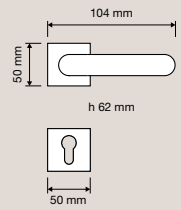

1625 RB 023
Maniglia con rosetta
art.023 / Door
handle on rose
art.023

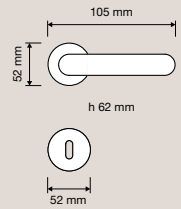

1625 RB 024
Maniglia con rosetta
art.024 / Door
handle on rose
art.024

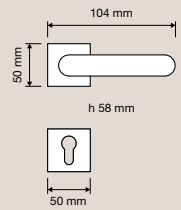

1625 RB 025
Maniglia con rosetta
art.025 / Door
handle on rose
art.025

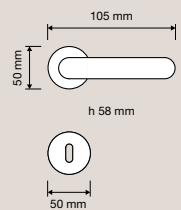

Era —



Il design moderno si combina con quello antico, in un design particolarissimo e unico che collega l'arte di un tempo alla funzionalità odierna con maestria ed eleganza.

Modern and antique come together in a very special and unique design that unites the art of yesteryear with the functionality of today.

Collezione / Collection

Finiture / Finishes



AC | Antracite satinato + cromo lucido / *Satin anthracite + polished chrome*

Finiture / Finishes



VN | Nero opaco + nero francese / *Matt black + french black*



AG | Antracite satinato + oro zecchino / *Satin anthracite + gold plated*



ZC | Oro zecchino + cromo lucido / *Gold plated + polished chrome*



AM | Antracite satinato + patiné / *Satin anthracite + patiné mat*



ZO | Nero opaco + oro zecchino / *Matt black + gold plated*



CC | Cromo satinato + cromo lucido / *Satin chrome + polished chrome*



CE | Nero opaco + cromo lucido / *Matt black + polished chrome*



NP | Bronzo opaco + patiné / *Matt bronze + patiné mat*

1600 RB 019

Maniglia con rosetta
art.019 / *Door handle on rose art.019*

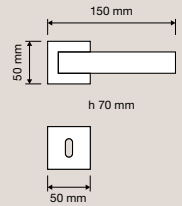

1600 RB 024

Maniglia con rosetta
art.024 / *Door handle on rose art.024*

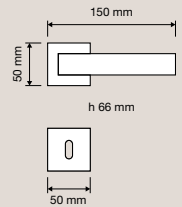

1600 PL

Maniglia con placca /
Door handle on plate

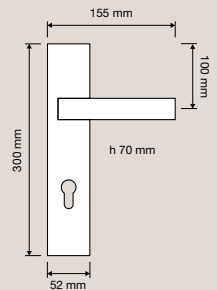

1600 DK

Maniglia per finestra
con movimento DK 4
posizioni / *Window handle with DK movement 4 clicks*

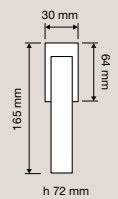

1600 SK

Maniglia per finestra
con movimento
DK SmartBlock /
Window handle with DK SmartBlock movement

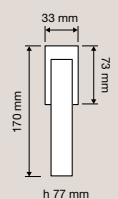

Collezione / Collection

1600 MN 400
Maniglione. Interassi
disponibili 300-
400. / Pull handle.
Available distances
300-400.

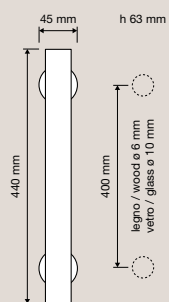



La rosetta e l'impugnatura minimaliste ed essenziali si contrappongono all'esuberante gambo in stile, ricco di fregi degni dei migliori ebanisti di un tempo, in un equilibrio dimensionale formale e stilistico perfetto.

The minimalist and simple rose and handgrip are in contrast to the exuberant stem, rich in friezes worthy of the best cabinetmakers of the past, in a perfectly formal and stylistic dimensional balance.

Fish —



Morbidezza e fluidità in una linea affusolata, con un richiamo esplicito all'ambiente marino.

Softness and fluidity in a streamlined design with an explicit reference to marine environments.

Finiture / Finishes



BM | Bronzo opaco /
Matt bronze



CR | Cromo lucido /
Polished chrome



CS | Cromo satinato /
Satin chrome



MC | Cromo sabbiato
+ cromo lucido / *Matt
chrome + polished
chrome*



OM | Oro sabbiato
+ oro / *Matt gold +
polished gold*



OZ | Oro zecchino /
Gold plated

Collezione / Collection

692 RB 023
Maniglia con rosetta
art.023 / *Door
handle on rose
art.023*

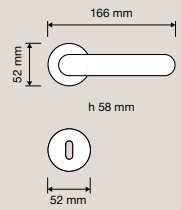

692 RB 025
Maniglia con rosetta
art.025 / *Door
handle on rose
art.025*

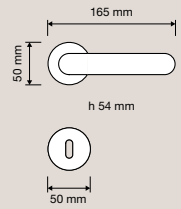

692 PL
Maniglia con placca
art.955 / *Door
handle on plate
art.955*

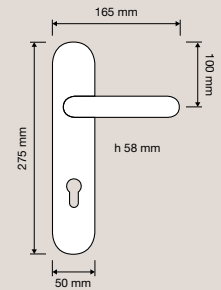

692 DK
Maniglia per finestra
con movimento DK 4
posizioni / *Window
handle with DK
movement 4 clicks*

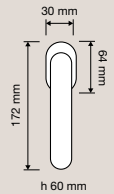

692 SK
Maniglia per finestra
con movimento
DK SmartBlock /
*Window handle
with DK SmartBlock
movement*

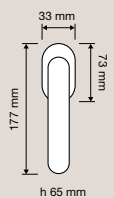

Grip —



Finiture / Finishes



CE | Cromo lucido +
nero opaco / *Polished
chrome + matt black*



CR | Cromo lucido /
Polished chrome



NP | Bronzo opaco +
patiné / *Matt bronze +
patiné mat*



OZ | Oro zecchino /
Gold plated



VE | Nero opaco / *Matt
black*

Una collezione contraddistinta da una moderna bellezza dalle mille sfaccettature, essenzialmente pratica ma piacevolmente decorativa.

A collection characterized by a modern beauty with a thousand facets, essentially practical but pleasantly decorative.

Collezione / Collection

1705 RB 023
Maniglia con rosetta
art.023 / Door
handle on rose
art.023

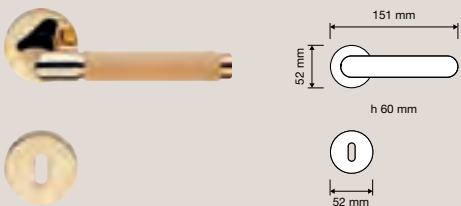

1705 RB 025
Maniglia con rosetta
art.025 / Door
handle on rose
art.025

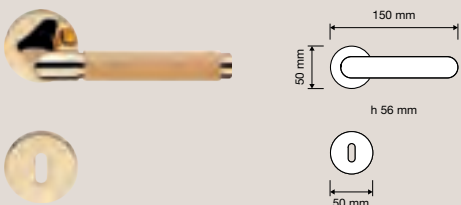

1705 PL
Maniglia con placca
art.1595 / Door
handle on plate
art.1595

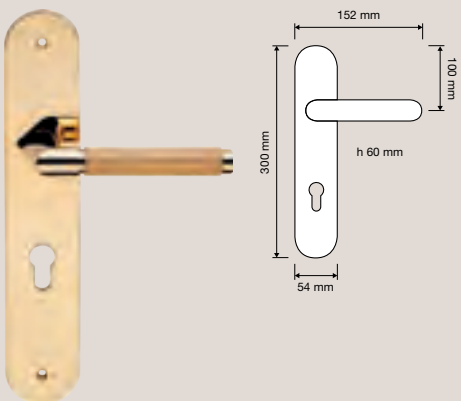

1705 DK
Maniglia per finestra
con movimento DK 4
posizioni / Window
handle with DK
movement 4 clicks



1705 SK
Maniglia per finestra
con movimento
DK SmartBlock /
Window handle
with DK SmartBlock
movement



1705 MN 245
Maniglione. Interassi
disponibili 245-341-
439. / Pull handle.
Available distances
245-341-439.

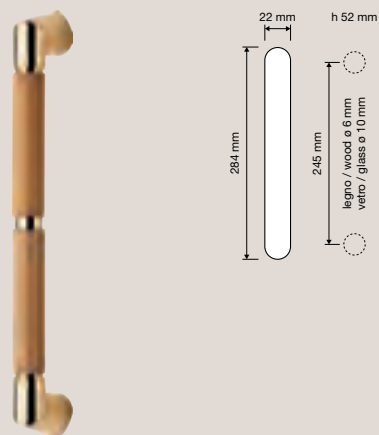

Grip Ebano

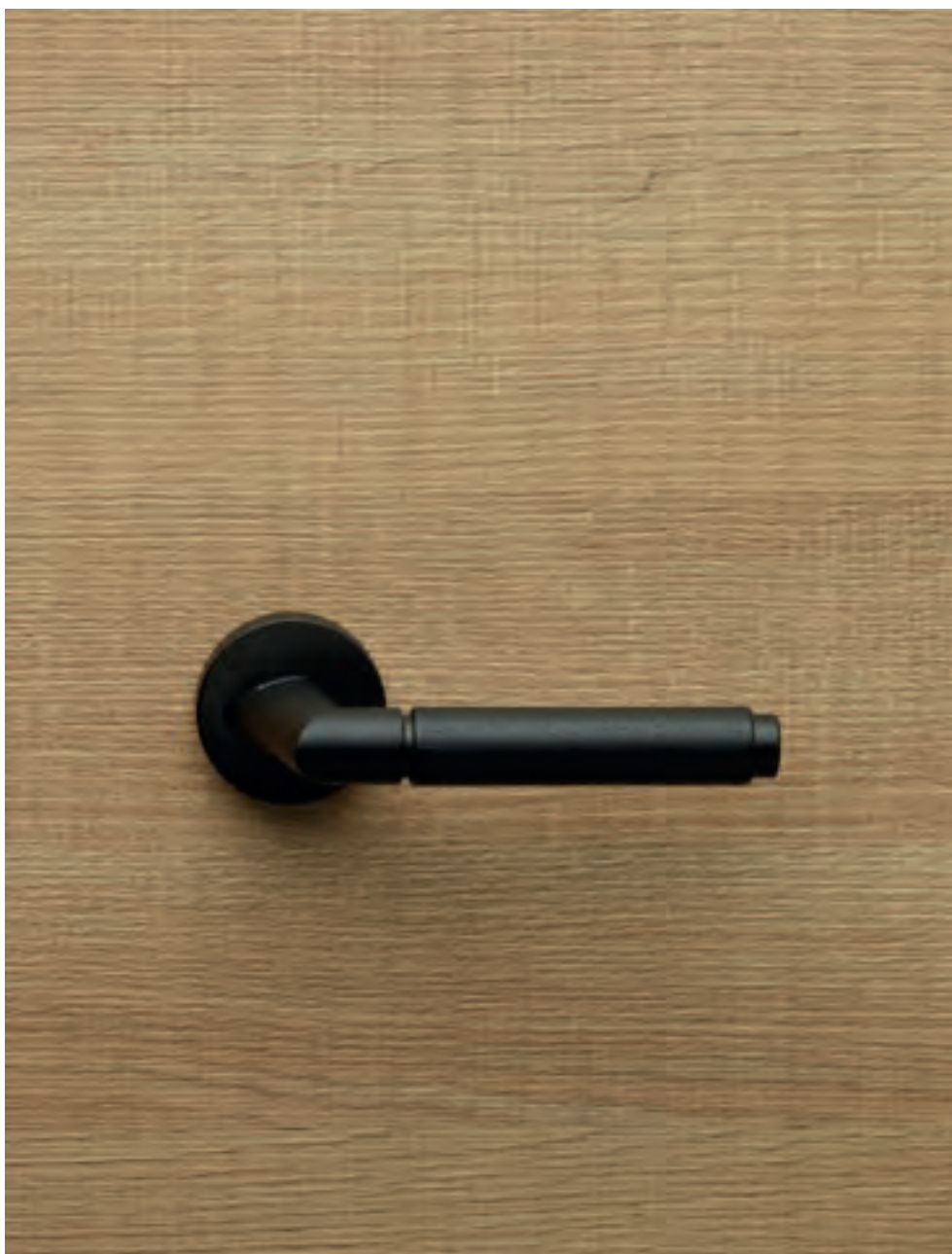

Finiture / Finishes



CR | Cromo lucido /
Polished chrome



OZ | Oro zecchino /
Gold plated



VE | Nero opaco / *Matt
black*

Una collezione lussuosa ma discreta
con un pregiato inserto in ebano a
formare l'impugnatura che trasmette
ed evoca piacevoli sensazioni.

*A luxurious but discreet collection
with a precious ebony insert to form
the handgrip that conveys and evokes
pleasant sensations.*

Collezione / Collection

1706 RB 023
Maniglia con rosetta
art.023 / Door
handle on rose
art.023

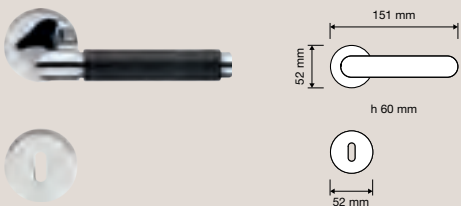

1706 RB 025
Maniglia con rosetta
art.025 / Door
handle on rose
art.025

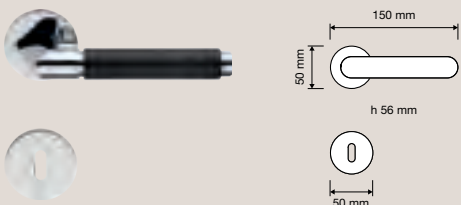

1706 PL
Maniglia con placca
art.1595 / Door
handle on plate
art.1595

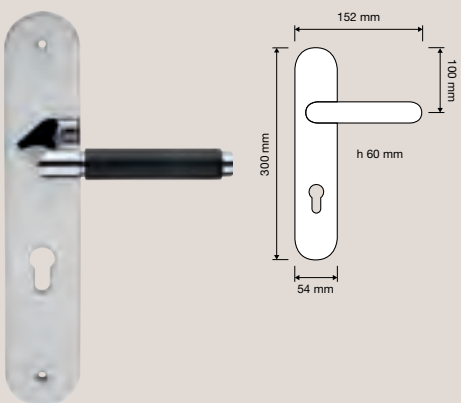

1706 DK
Maniglia per finestra
con movimento DK 4
posizioni / Window
handle with DK
movement 4 clicks

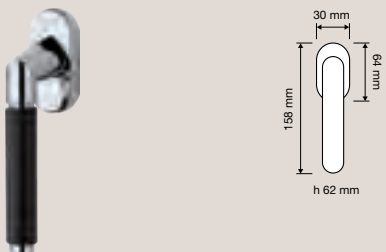

1706 SK
Maniglia per finestra
con movimento
DK SmartBlock /
Window handle
with DK SmartBlock
movement

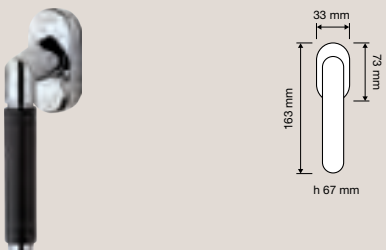

1706 MN 245
Maniglione. Interassi
disponibili 245-341-
439. / Pull handle.
Available distances
245-341-439.

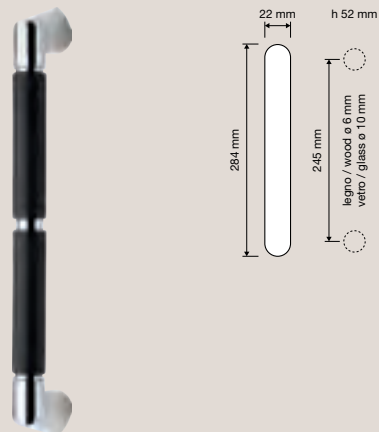

Grip Pelle _



Il fascino indiscusso della pelle veste questa moderna collezione nata con l'intento di completare l'arredo di residenze esclusive e di pregio.

The undisputed charm of leather dresses this modern collected created with the intention of completing the furnishings of exclusive and prestigious homes.

Collezione / Collection

Finiture / Finishes



BM | Bronzo opaco /
Matt bronze



CR | Cromo lucido /
Polished chrome



OZ | Oro zecchino /
Gold plated



VE | Nero opaco / Matt
black

Pelle / Leather



1711 | Nera / Black



1713 | Grigia / Grey

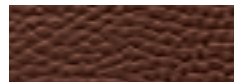

1714 | Marrone / Brown



1715 | Beige / Beige

1711 RB 023
Maniglia con rosetta
art.023 / Door
handle on rose
art.023

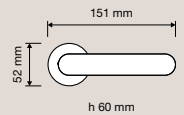

1711 RB 025
Maniglia con rosetta
art.025 / Door
handle on rose
art.025

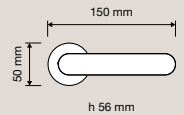

1711 PL
Maniglia con placca
art.1595 / Door
handle on plate
art.1595

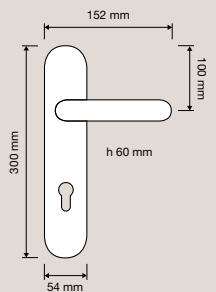

1711 DK
Maniglia per finestra
con movimento DK 4
posizioni / Window
handle with DK
movement 4 clicks

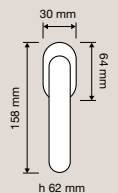

1711 SK
Maniglia per finestra
con movimento
DK SmartBlock /
Window handle
with DK SmartBlock
movement

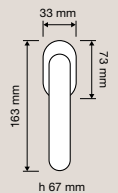

Collezione / Collection

1711 MN 245
Maniglione. Interassi
disponibili 245-341-
439. / Pull handle.
Available distances
245-341-439.

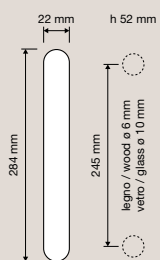



La sensazione che si prova afferrandola è duplice: da un lato stupisce per la sua inaspettata morbidezza che accarezza il palmo della mano, dall'altra trasmette una piacevole sensazione di calore.

The sensation felt when you hold it is twofold: on the one hand, the unexpected softness that caresses the hand surprises us, on the other it transmits a pleasant feeling of warmth.

Ibis



Finiture / Finishes



CR | Cromo lucido /
Polished chrome



CS | Cromo satinato /
Satin chrome



OL | Ottone lucido
verniciato / *Polished
brass*



OZ | Oro zecchino /
Gold plated



PM | Patiné / *Patiné
mat*



VE | Nero opaco / *Matt
black*

Linee sinuose si rincorrono dando vita a una forma naturale che, idealmente, ricorda un ramo sulla quale si è appoggiato l'ibis, uccello americano dal piumaggio rosso come il tramonto.

Sinuous lines follow each other giving life to a natural form that ideally resembles a branch on which an ibis is perched, an American bird with scarlet feathers like a sunset.

Collezione / Collection

691 RB 023
Maniglia con rosetta
art.023 / Door
handle on rose
art.023

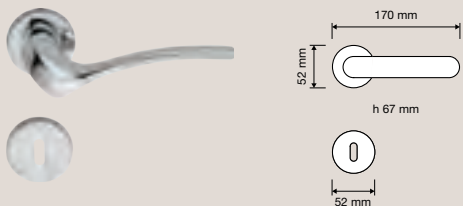

691 RB 025
Maniglia con rosetta
art.025 / Door
handle on rose
art.025

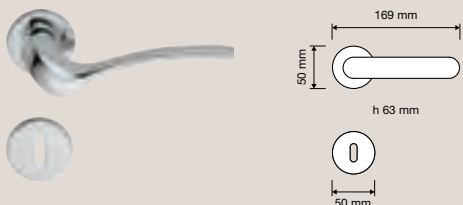

719 PL
Maniglia con placca
art.1595 / Door
handle on plate
art.1595

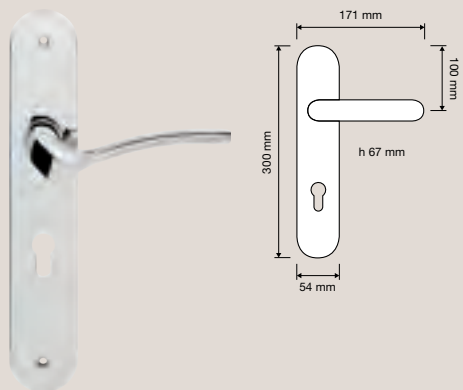

691 DK
Maniglia per finestra
con movimento DK 4
posizioni / Window
handle with DK
movement 4 clicks

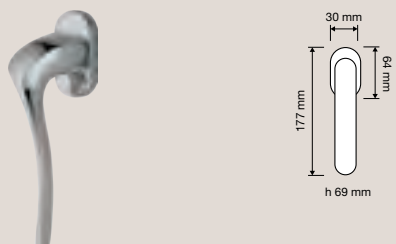

691 SK
Maniglia per finestra
con movimento
DK SmartBlock /
Window handle
with DK SmartBlock
movement

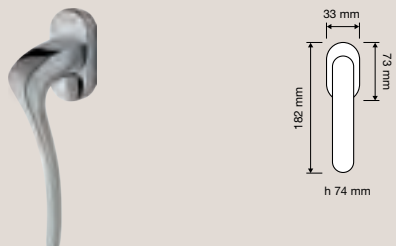

691 MN 300
Maniglione / Pull
handle

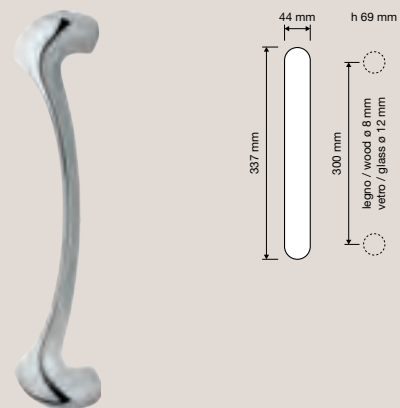

Jenny —



Espressione della semplicità assoluta, la maniglia Jenny metabolizza il fascino e la discreta eleganza del lusso contemporaneo.

Expression of absolute simplicity, the new Jenny handle metabolizes the charm and discreet elegance of contemporary luxury.

Finiture / Finishes



BL | Cromo lucido + bianco lucido / *Polished chrome + glossy white*



BT | Cromo satinato + bianco lucido / *Satin chrome + glossy white*



CC | Cromo satinato + cromo lucido / *Satin chrome + polished chrome*



CE | Cromo lucido + nero opaco / *Polished chrome + matt black*



CN | Cromo lucido + nickel satinato / *Polished chrome + satin nickel*



OT | Ottone lucido + ottone satinato / *Polished brass + satin brass*



RS | Cromo lucido + cromo satinato / *Polished chrome + satin chrome*



SE | Cromo satinato + nero opaco / *Satin chrome + matt black*

Collezione / Collection

1730 RB 025
Maniglia con rosetta
art.025 / Door
handle on rose
art.025

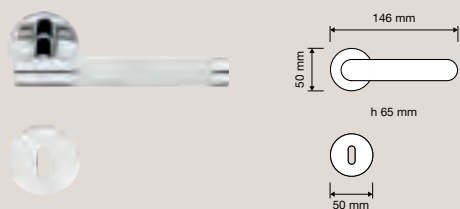

1730 PL
Maniglia con placca
art.123 / Door handle
on plate art.123

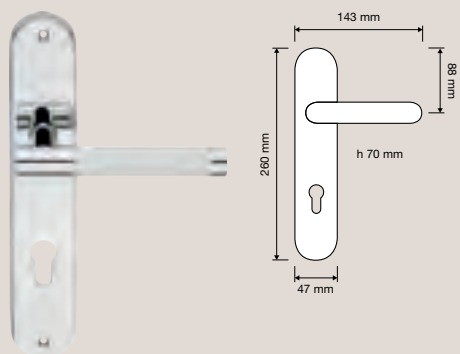

1730 DK
Maniglia per finestra
con movimento DK 4
posizioni / Window
handle with DK
movement 4 clicks

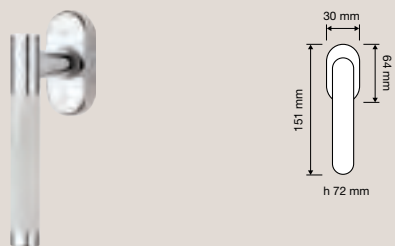

1730 SK
Maniglia per finestra
con movimento
DK SmartBlock /
Window handle
with DK SmartBlock
movement

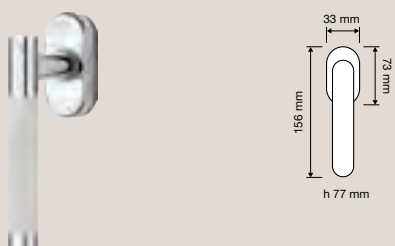

1730 MN 300
Maniglione. Interassi
disponibili 300-
500. / Pull handle.
Available distances
300-500.

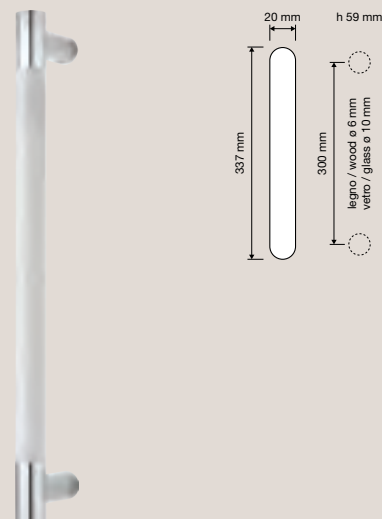

Jet



Finiture / Finishes



CR | Cromo lucido /
Polished chrome



CS | Cromo satinato /
Satin chrome



OZ | Oro zecchino /
Gold plated



VE | Nero opaco / *Matt
black*

Linee taglienti, sapientemente smussate e perciò morbide e piacevoli al tatto, talmente perfette e armoniche da non dover aggiungere altro.

Sharp, cleverly contoured lines and hence soft and pleasant to the touch, so perfect and harmonious that there's no need to add anything else.

Collezione / Collection

1425 RB 019
Maniglia con rosetta
art.019 / Door handle
on rose art.019

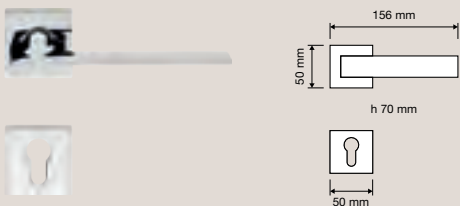

1425 RB 023
Maniglia con rosetta
art.023 / Door
handle on rose
art.023

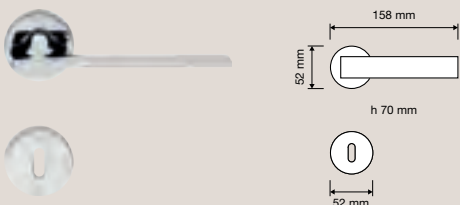

1425 RB 024
Maniglia con rosetta
art.024 / Door
handle on rose
art.024

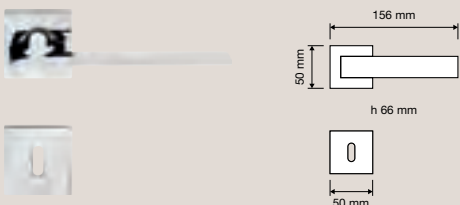

1425 RB 025
Maniglia con rosetta
art.025 / Door
handle on rose
art.025

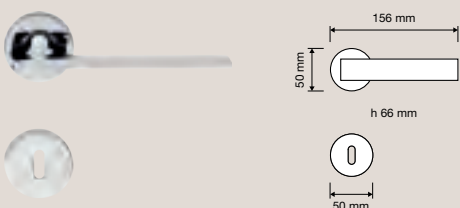

1425 PL
Maniglia con placca /
Door handle on plate

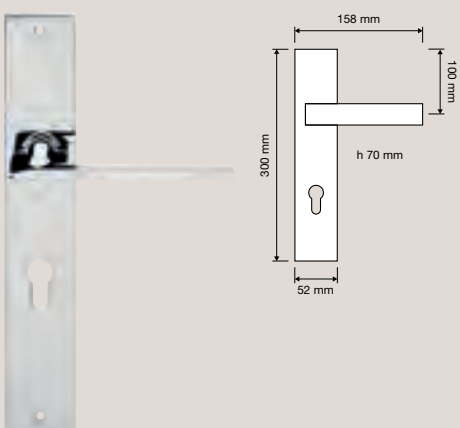

1425 DK
Maniglia per finestra
con movimento DK 4
posizioni / Window
handle with DK
movement 4 clicks

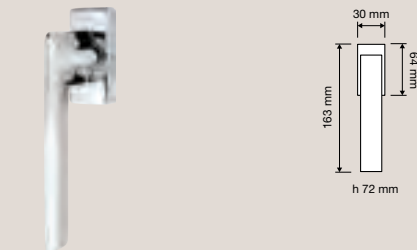

1425 SK
Maniglia per finestra
con movimento
DK SmartBlock /
Window handle
with DK SmartBlock
movement

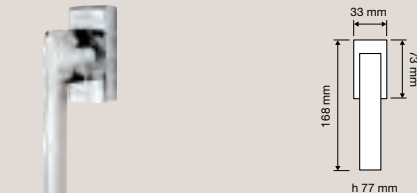

Kendo _



Ispirata allo Shinai, la spada utilizzata dai Samurai, questa collezione definisce una nuova via del design contemporaneo.

Inspired by Shinai, the sword used by the Samurai, this collection defines a new way of contemporary design.

Collezione / Collection

Finiture / Finishes



BM | Bronzo opaco /
Matt bronze



CR | Cromo lucido /
Polished chrome



CS | Cromo satinato /
Satin chrome



OZ | Oro zecchino /
Gold plated

1516 RB 023
Maniglia con rosetta
art.023 / Door
handle on rose
art.023

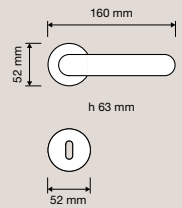

1516 RB 025
Maniglia con rosetta
art.025 / Door
handle on rose
art.025

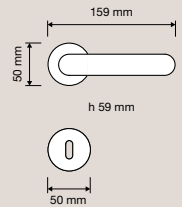

1518 PL
Maniglia con placca
art.1595 / Door
handle on plate
art.1595

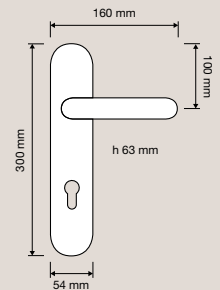

1516 DK
Maniglia per finestra
con movimento DK 4
posizioni / Window
handle with DK
movement 4 clicks

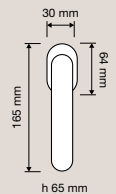

1516 SK
Maniglia per finestra
con movimento
DK SmartBlock /
Window handle
with DK SmartBlock
movement

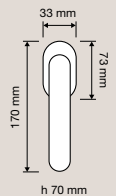

Collezione / Collection

1516 MN 180
Maniglione / Pull
handle

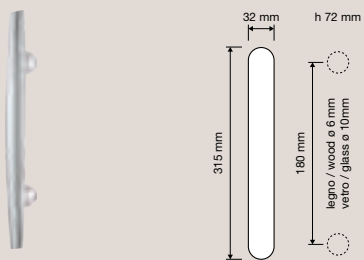

1517 SL
Maniglione mm 180
su placca Open Big
art.1106 / Pull handle
mm 180 on Open Big
plate art.1106

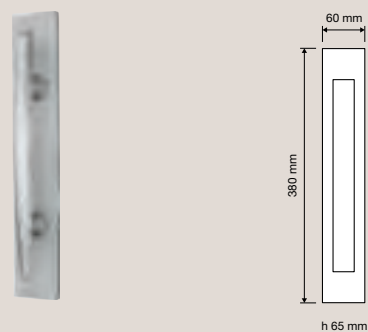

1516 MN 390
Maniglione / Pull
handle

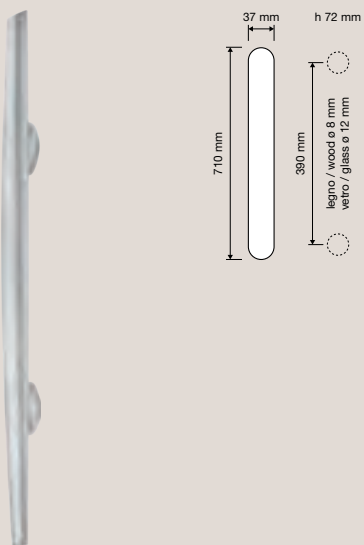

1516 MZ 300
Maniglione zancato /
Offset pull handle

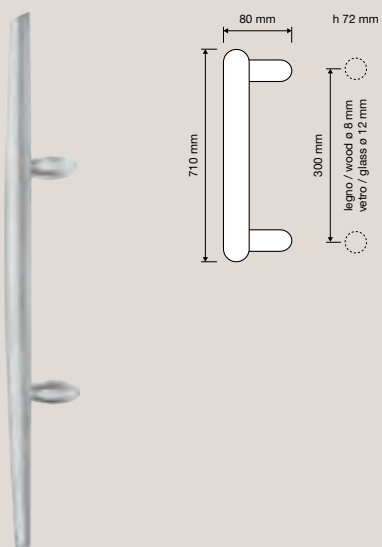



Il maniglione per porte mantiene gli stessi stilemi che hanno reso questa collezione unica nel suo genere, e cioè la forma ellissoidale dell'impugnatura che tende ad avvitarsi su se stessa definendo un comodo appoggio e creando una sorta di invito alla mano.

The pull handle for doors maintains the same stylistic features that made this collection unique, namely the ellipsoidal shape of the handgrip that tends to twist giving it a comfortable support and creating a sort of invitation to the hand.

Komfort —



Una maniglia dalle molteplici personalità, ironica e giocosa, pragmatica e complessa, dove le linee si rincorrono dando vita a una forma indefinibile ma “concreta”.

A handle with multiple personalities, ironic and playful, pragmatic and complex, where the lines follow one another giving life to an undefinable but “concrete” form.

Collezione / Collection

Finiture / Finishes



CR | Cromo lucido /
Polished chrome



CS | Cromo satinato /
Satin chrome



OZ | Oro zecchino /
Gold plated



PM | Patiné / Patiné
mat

1455 RB 023
Maniglia con rosetta
art.023 / Door
handle on rose
art.023

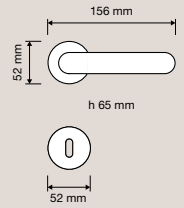

1455 RB 025
Maniglia con rosetta
art.025 / Door
handle on rose
art.025

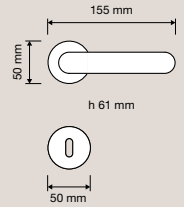

1457 PL
Maniglia con placca
art.1595 / Door
handle on plate
art.1595

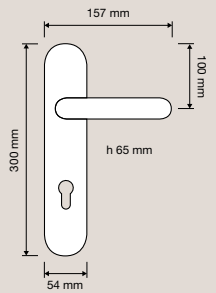
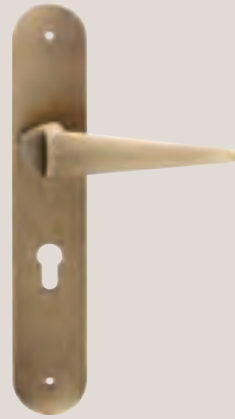

1455 DK
Maniglia per finestra
con movimento DK 4
posizioni / Window
handle with DK
movement 4 clicks

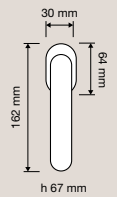

1455 SK
Maniglia per finestra
con movimento
DK SmartBlock /
Window handle
with DK SmartBlock
movement

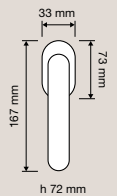

Living —



Una collezione che cambia radicalmente aspetto a seconda del punto di vista trasformandosi in classica o moderna, riuscendo così a entrare in perfetta sintonia con l'arredo circostante.

A collection that radically changes aspect depending on the point of view, transforming itself into classic or modern, thus managing to be in perfect harmony with the surrounding furniture.

Collezione / Collection

Finiture / Finishes



BM | Bronzo opaco /
Matt bronze



CR | Cromo lucido /
Polished chrome



CS | Cromo satinato /
Satin chrome



OZ | Oro zecchino /
Gold plated

1690 RB 023
Maniglia con rosetta
art.023 / Door
handle on rose
art.023

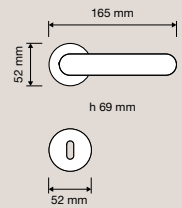

1690 RB 025
Maniglia con rosetta
art.025 / Door
handle on rose
art.025

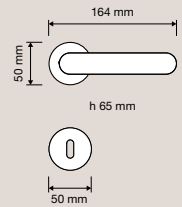

1691 PL
Maniglia con placca
art.1595 / Door
handle on plate
art.1595

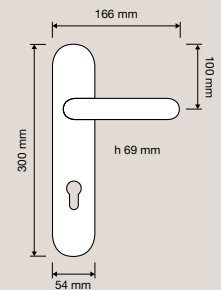

1690 DK
Maniglia per finestra
con movimento DK 4
posizioni / Window
handle with DK
movement 4 clicks

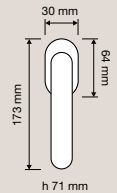

1690 SK
Maniglia per finestra
con movimento
DK SmartBlock /
Window handle
with DK SmartBlock
movement

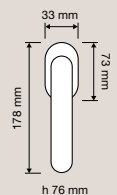

Nau _



Una spirale di design che, grazie all'insolita silhouette, funge da elemento di stacco e congiunzione con lo spazio circostante.

A spiral design which, thanks to the unusual silhouette, acts as an element of separation and conjunction with the surrounding space.

Collezione / Collection

Finiture / Finishes



BM | Bronzo opaco /
Matt bronze



CR | Cromo lucido /
Polished chrome



CS | Cromo satinato /
Satin chrome



OZ | Oro zecchino /
Gold plated

1548 RB 023
Maniglia con rosetta
art.023 / Door handle
on rose art.023

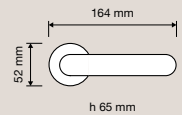

1548 RB 025
Maniglia con rosetta
art.025 / Door handle
on rose art.025

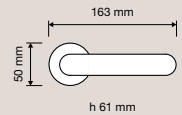

1552 PL
Maniglia con placca
art.1595 / Door
handle on plate
art.1595

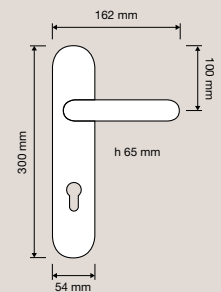

1548 DK
Maniglia per finestra
con movimento DK 4
posizioni / Window
handle with DK
movement 4 clicks

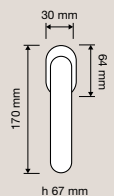

1548 SK
Maniglia per finestra
con movimento
DK SmartBlock /
Window handle
with DK SmartBlock
movement

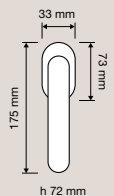

Point —



Una collezione di maniglie priva di ogni orpello e per questo sofisticata e unica nel suo genere.

A collection of handles without any frills and for this reason sophisticated and unique.

Collezione / Collection

Finiture / Finishes



AS | Antracite satinato / *Satin anthracite*



CR | Cromo lucido / *Polished chrome*



CS | Cromo satinato / *Satin chrome*



OZ | Oro zecchino / *Gold plated*

1595 RB 023
Maniglia con rosetta
art.023 / *Door
handle on rose
art.023*

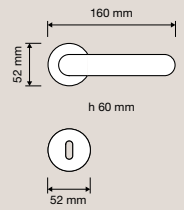

1595 RB 025
Maniglia con rosetta
art.025 / *Door
handle on rose
art.025*

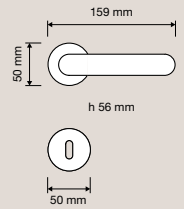

1595 PL
Maniglia con placca /
Door handle on plate

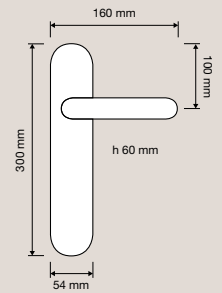

1595 DK
Maniglia per finestra
con movimento DK 4
posizioni / *Window
handle with DK
movement 4 clicks*

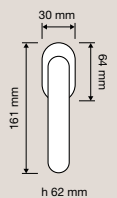

1595 SK
Maniglia per finestra
con movimento
DK SmartBlock /
*Window handle
with DK SmartBlock
movement*

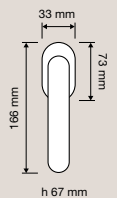

Prisma —



Il design particolarmente eclettico e inconsueto, caratterizzato da un'impugnatura di forma romboidale, ne fa il complemento d'arredo ideale per gli ambienti più moderni.

The particularly eclectic and unusual design, characterized by the rhomboid shaped handgrip, make it the ideal furnishing accessory for the most modern environments.

Collezione / Collection

Finiture / Finishes



CR | Cromo lucido /
Polished chrome



CS | Cromo satinato /
Satin chrome



MC | Cromo sabbato
+ cromo lucido / *Matt
chrome + polished
chrome*



OM | Oro sabbato
+ oro / *Matt gold +
polished gold*

1280 RB 019
Maniglia con rosetta
art.019 / *Door handle
on rose art.019*

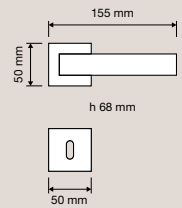

1280 RB 024
Maniglia con rosetta
art.024 / *Door
handle on rose
art.024*

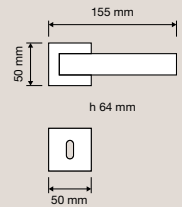

1281 PL
Maniglia con placca
art.1104 / *Door
handle on plate
art.1104*

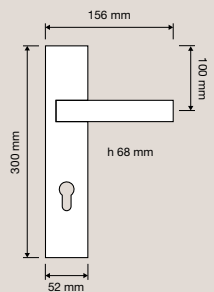

1280 DK
Maniglia per finestra
con movimento DK 4
posizioni / *Window
handle with DK
movement 4 clicks*

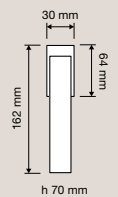

1280 SK
Maniglia per finestra
con movimento
DK SmartBlock /
*Window handle
with DK SmartBlock
movement*

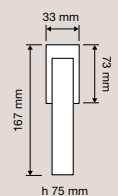

Profilo



Finiture / Finishes



CR | Cromo lucido /
Polished chrome



CS | Cromo satinato /
Satin chrome



MC | Cromo sabbato
+ cromo lucido / *Matt
chrome + polished
chrome*



OL | Ottone lucido
verniciato (non
disponibile per
maniglie con rosetta
art.019 e art.024) /
*Polished brass (not
available for door
handles on rose
art.019 and art.024)*



OM | Oro sabbato
+ oro / *Matt gold +
polished gold*

Grazie al suo design senza tempo si
coordina con facilità a ogni ambiente
e a ogni tipologia di porta, da quelle
laccate a quelle in essenza.

*Thanks to its timeless design fits in
easily with all environments and doors,
from lacquered to natural wood doors.*

Collezione / Collection

1040 RB 019
Maniglia con rosetta
art.019 / Door handle
on rose art.019

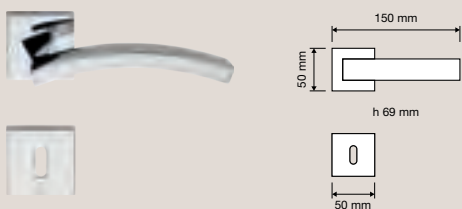

1040 RB 024
Maniglia con rosetta
art.024 / Door
handle on rose
art.024

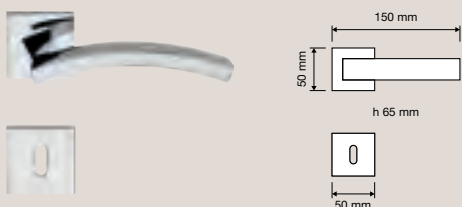

1040 RB 088
Maniglia con rosetta
art.088 / Door
handle on rose
art.088

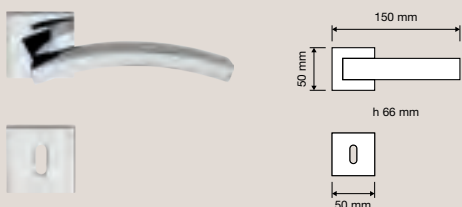

1040 RB 102
Maniglia con rosetta
art.102 / Door handle
on rose art.102

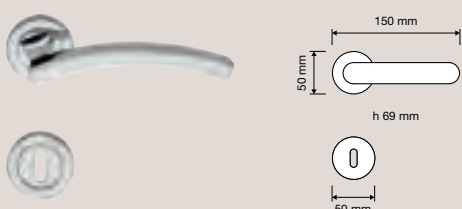

1040 PL
Maniglia con placca
art.1040 / Door
handle on plate
art.1040

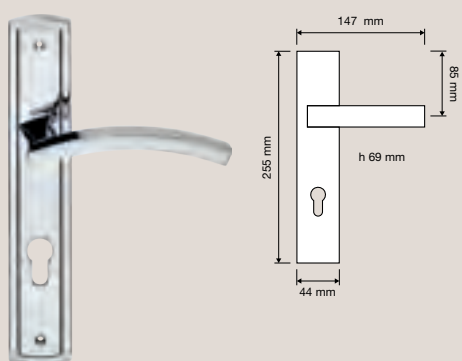

1040 CR
Cremonese /
Window handle gratz



1040 DK
Maniglia per finestra
con movimento DK 4
posizioni / Window
handle with DK
movement 4 clicks



1040 SK
Maniglia per finestra
con movimento
DK SmartBlock /
Window handle
with DK SmartBlock
movement



1040 MN 240
Maniglione / Pull
handle

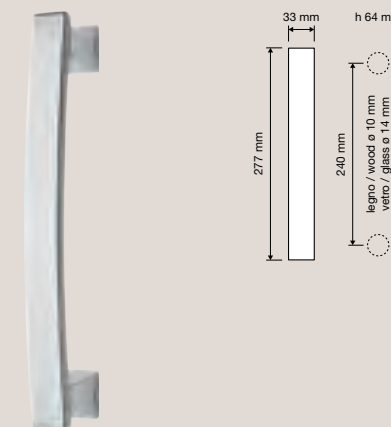

1042 PI
Placca incasso /
Flush pull

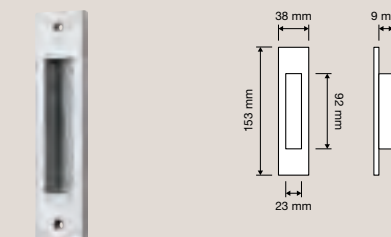

Riflesso —



Una collezione che vuole essere protagonista, caratterizzata da un'impugnatura importante capace di riflettere l'ambiente circostante.

A collection that aims for the leading role, characterised by an imposing handgrip that is capable of reflecting its surroundings.

Collezione / Collection

Finiture / Finishes



CR | Cromo lucido /
Polished chrome



CS | Cromo satinato /
Satin chrome



VE | Nero opaco / Matt
black

1360 RB 019
Maniglia con rosetta
art.019 / Door handle
on rose art.019

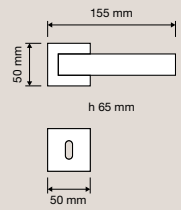

1360 RB 024
Maniglia con rosetta
art.024 / Door
handle on rose
art.024

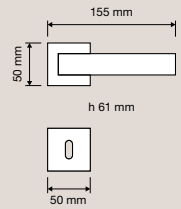

1360 PL
Maniglia con placca /
Door handle on plate

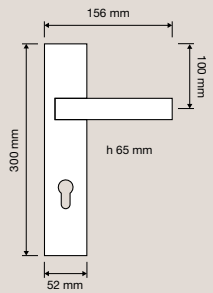

1360 DK
Maniglia per finestra
con movimento DK 4
posizioni / Window
handle with DK
movement 4 clicks

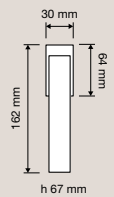

1360 SK
Maniglia per finestra
con movimento
DK SmartBlock /
Window handle
with DK SmartBlock
movement

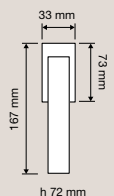

Rombo



Finiture / Finishes



CR | Cromo lucido /
Polished chrome



CS | Cromo satinato /
Satin chrome



OZ | Oro zecchino /
Gold plated

Un design eclettico che non scende
a compromessi dedicato a chi è
coraggioso e determinato nello stile.

*An eclectic design without compromise
dedicated to those looking for a daring
and determined style.*

Collezione / Collection

1420 RB 019
Maniglia con rosetta
art.019 / Door handle
on rose art.019

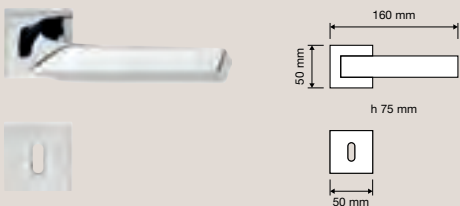

1420 DK
Maniglia per finestra
con movimento DK 4
posizioni / Window
handle with DK
movement 4 clicks



1420 RB 024
Maniglia con rosetta
art.024 / Door
handle on rose
art.024

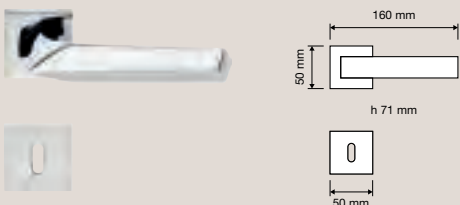

1420 SK
Maniglia per finestra
con movimento
DK SmartBlock /
Window handle
with DK SmartBlock
movement

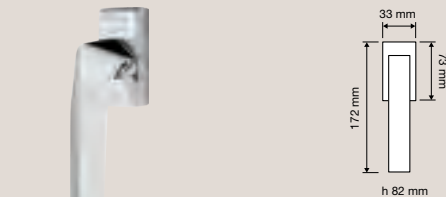

1420 PL
Maniglia con placca
art.1104 / Door
handle on plate
art.1104

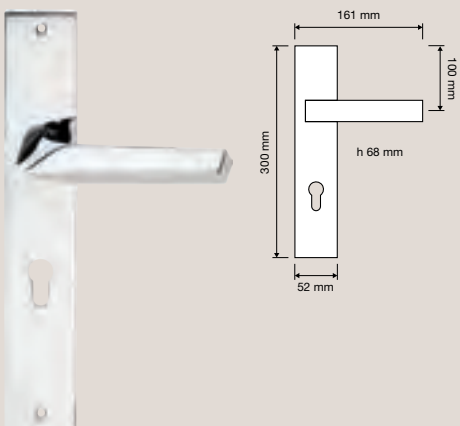

1421 PL
Maniglia con placca
art.1106 / Door
handle on plate
art.1106

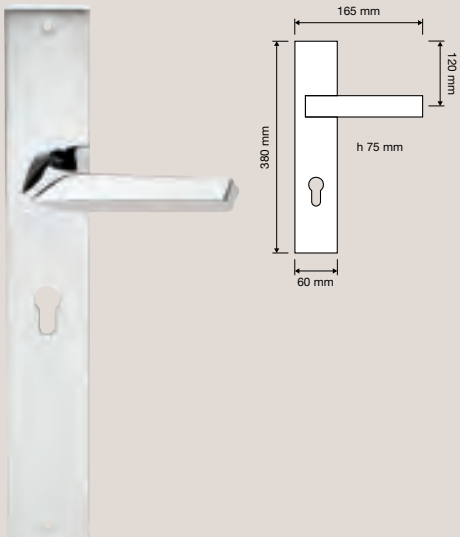

Sintesi —



Linee decise, lineari e rigorose, ne fanno un complemento d'arredo perfetto per tutti quegli ambienti dove il design regna sovrano.

Decisive, linear and meticulous lines, make it the perfect furnishing accessory for all surroundings where design reigns supreme.

Collezione / Collection

Finiture / Finishes



CR | Cromo lucido /
Polished chrome



CS | Cromo satinato /
Satin chrome

1300 RB 019
Maniglia con rosetta
art.019 / Door handle
on rose art.019

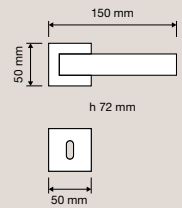

1300 RB 024
Maniglia con rosetta
art.024 / Door
handle on rose
art.024

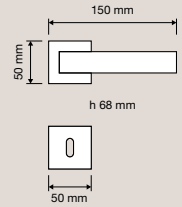

1300 PL
Maniglia con placca /
Door handle on plate

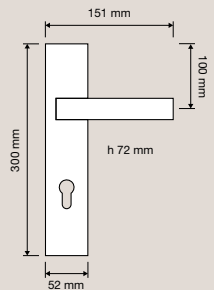

1300 DK
Maniglia per finestra
con movimento DK 4
posizioni / Window
handle with DK
movement 4 clicks

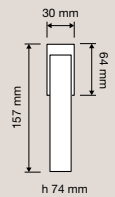

1300 SK
Maniglia per finestra
con movimento
DK SmartBlock /
Window handle
with DK SmartBlock
movement

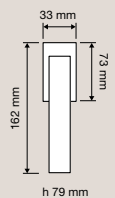

Sintesi Wengè —



Il fascino del legno pregiato proveniente dalle foreste tropicali dona un tocco quasi esotico a questa collezione, caratterizzata da linee estremamente semplici e pulite.

The fascination of precious wood from tropical forests gives this collection an almost exotic taste, characterised by extremely simple and clean lines.

Collezione / Collection

Finiture / Finishes



CR | Cromo lucido /
Polished chrome



CS | Cromo satinato /
Satin chrome



OZ | Oro zecchino /
Gold plated

1304 RB 019
Maniglia con rosetta
art.019 / Door handle
on rose art.019

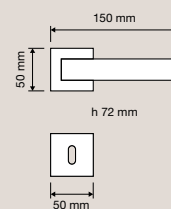

1304 RB 024
Maniglia con rosetta
art.024 / Door
handle on rose
art.024

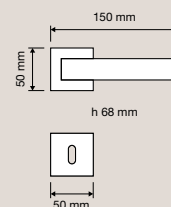

1304 PL
Maniglia con placca /
Door handle on plate

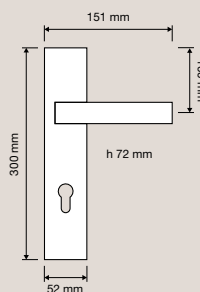

1304 DK
Maniglia per finestra
con movimento DK 4
posizioni / Window
handle with DK
movement 4 clicks

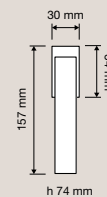

1304 SK
Maniglia per finestra
con movimento
DK SmartBlock /
Window handle
with DK SmartBlock
movement

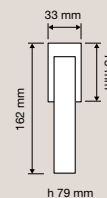

Slim



Finiture / Finishes



CE | Cromo lucido +
nero opaco / *Polished
chrome + matt black*



CR | Cromo lucido /
Polished chrome



CS | Cromo satinato /
Satin chrome



OS | Ottone satinato
(non disponibile per
maniglie con rosetta
art.019 e art.024)
/ *Satin brass (not
available for door
handles on rose
art.019 and art.024)*

Un gioco di forme e volumi differenti contraddistingue il design di questa collezione che gioca con le differenti proporzioni di ogni sua componente.

A combination of forms and volumes characterises the design of this collection that plays with the different proportions of each component.

Collezione / Collection

1110 RB 019
 Maniglia con rosetta
 art.019 / Door handle
 on rose art.019

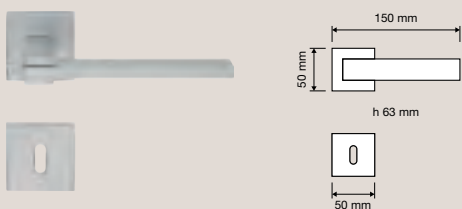

1110 RB 024
 Maniglia con rosetta
 art.024 / Door
 handle on rose
 art.024

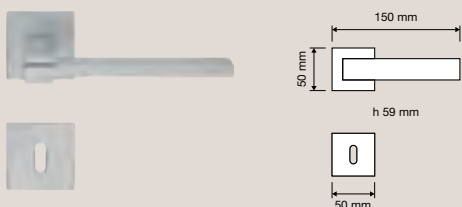

1110 RB 088
 Maniglia con rosetta
 art.088 / Door
 handle on rose
 art.088

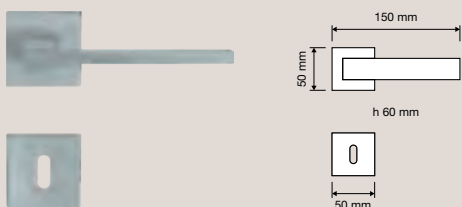

1110 PL
 Maniglia con placca /
 Door handle on plate

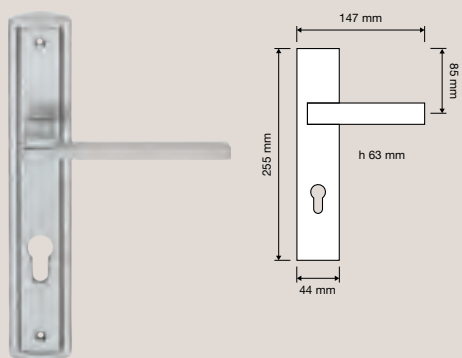

1110 DK
 Maniglia per finestra
 con movimento DK 4
 posizioni / Window
 handle with DK
 movement 4 clicks



1110 SK
 Maniglia per finestra
 con movimento
 DK SmartBlock /
 Window handle
 with DK SmartBlock
 movement

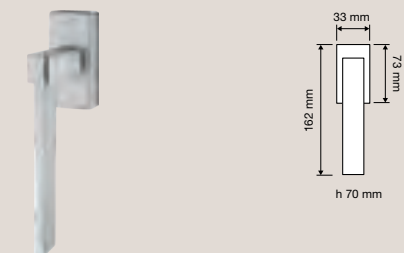

1110 MN 240
 Maniglione. Interassi
 disponibili 240-300-
 400-600-800. / Pull
 handle. Available
 distances 240-300-
 400-600-800.

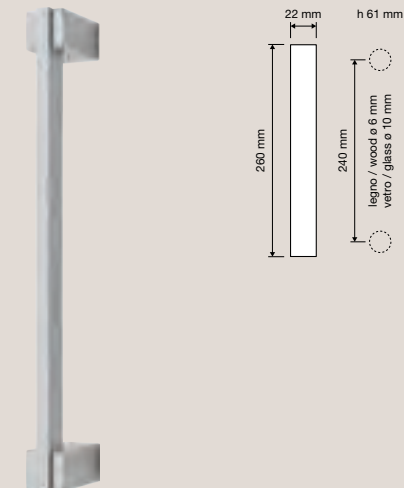

1110 MZ 240
 Maniglione zancato.
 Interassi disponibili
 240-300-400-600-
 800. / Offset pull
 handle. Available
 distances 240-300-
 400-600-800.

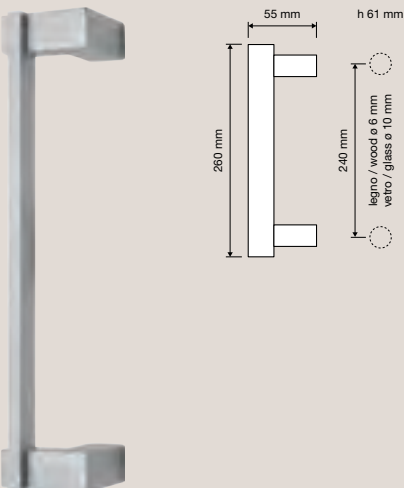

Slim Pelle _



Il gioco di forme e volumi differenti dal sapore particolarmente moderno viene reso più classico grazie all'impugnatura rivestita in vera pelle italiana, naturale espressione della lavorazione artistica del pellame.

A combination of diverse forms and volumes with a particularly modern flavour is given a classical touch thanks to the handgrip in real Italian leather, a natural expression of the artistic handcrafting of leather.

Collezione / Collection

Finiture / Finishes



CR | Cromo lucido /
Polished chrome



CS | Cromo satinato /
Satin chrome



OL | Ottone lucido
verniciato (non
disponibile per
maniglie con rosetta
art.019 e art.024) /
Polished brass (not
available for door
handles on rose
art.019 and art.024)

Pelle / Leather



1111 | Nera / Black



1112 | Marrone / Brown

1111 RB 019
Maniglia con rosetta
art.019 / Door handle
on rose art.019

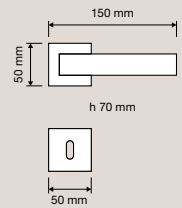

1111 RB 024
Maniglia con rosetta
art.024 / Door
handle on rose
art.024

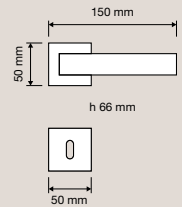

1111 RB 088
Maniglia con rosetta
art.088 / Door
handle on rose
art.088

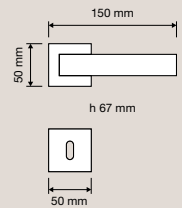

1111 PL
Maniglia con placca /
Door handle on plate

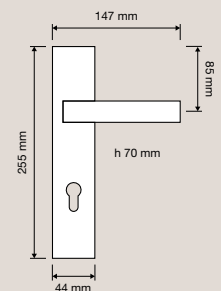

1111 DK
Maniglia per finestra
con movimento DK 4
posizioni / Window
handle with DK
movement 4 clicks

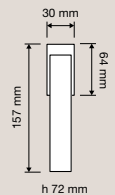

Collezione / Collection

1111 SK
Maniglia per finestra
con movimento
DK SmartBlock /
Window handle
with DK SmartBlock
movement

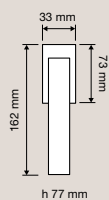

1111 MN 240
Maniglione. Interassi
disponibili 240-300-
400-600-800. / Pull
handle. Available
distances 240-300-
400-600-800.

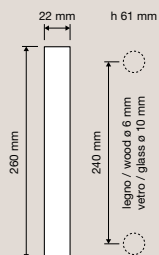

1111 MZ 240
Maniglione zancato.
Interassi disponibili
240-300-400-600-
800. / Offset pull
handle. Available
distances 240-300-
400-600-800.

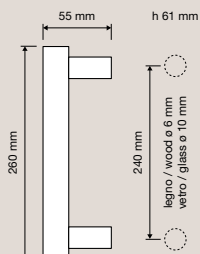



L'impugnatura di questa maniglia in ottone è stata "vestita" di pregiata pelle, conciata artigianalmente in Italia, che trasmette una piacevole sensazione di morbidezza alla mano.

The handgrip of this brass handle has been "dressed" in premium leather, tanned by craftsmen in Italy that transmits a pleasant sensation of softness to the hand.

Spirit



Finiture / Finishes



BM | Bronzo opaco /
Matt bronze



CR | Cromo lucido /
Polished chrome



CS | Cromo satinato /
Satin chrome



OZ | Oro zecchino /
Gold plated

Le forme audaci e seducenti di un fiore danno vita a questa collezione di maniglie particolarmente sexy e insolita.

The audacious and seductive forms of a flower give life to this particularly sexy and unusual collection of handles.

Collezione / Collection

1450 RB 023
Maniglia con rosetta
art.023 / Door
handle on rose
art.023

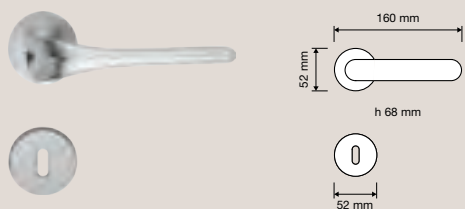

1450 RB 025
Maniglia con rosetta
art.025 / Door
handle on rose
art.025

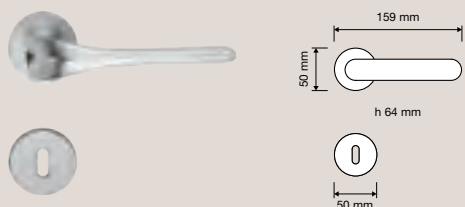

1454 PL
Maniglia con placca
art.1595 / Door
handle on plate
art.1595

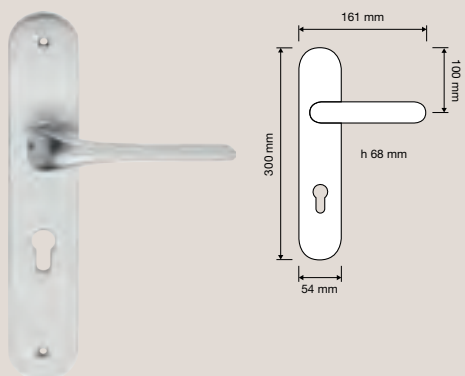

1450 DK
Maniglia per finestra
con movimento DK 4
posizioni / Window
handle with DK
movement 4 clicks

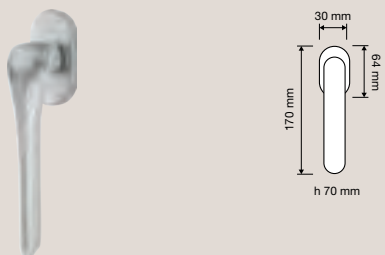

1450 SK
Maniglia per finestra
con movimento
DK SmartBlock /
Window handle
with DK SmartBlock
movement

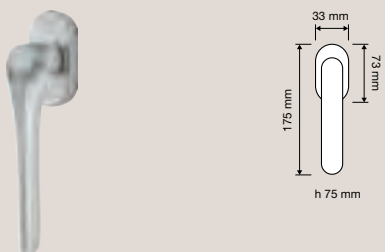

1450 MN 300
Maniglione / Pull
handle

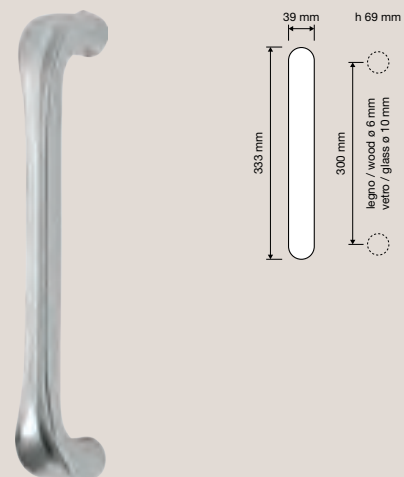

Strip —



Una maniglia che si svela a ogni sguardo, con il suo insolito profilo ovale traslato che accoglie la mano con discrezione.

A handle that reveals itself at every glance with its unusual oval shifted profile that discreetly accommodates the hand.

Finiture / Finishes



CR | Cromo lucido /
Polished chrome



CS | Cromo satinato /
Satin chrome



OL | Ottone lucido
verniciato / Polished
brass



OZ | Oro zecchino /
Gold plated



PM | Patiné / Patiné
mat



VE | Nero opaco / Matt
black

Collezione / Collection

1660 RB 023
Maniglia con rosetta
art.023 / Door
handle on rose
art.023

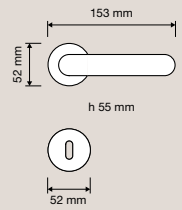

1660 RB 025
Maniglia con rosetta
art.025 / Door
handle on rose
art.025

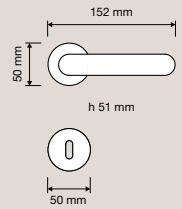

1660 PL
Maniglia con placca /
Door handle on plate

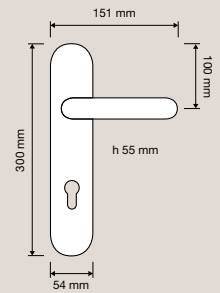

1660 DK
Maniglia per finestra
con movimento DK 4
posizioni / Window
handle with DK
movement 4 clicks

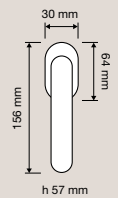

1660 SK
Maniglia per finestra
con movimento
DK SmartBlock /
Window handle
with DK SmartBlock
movement

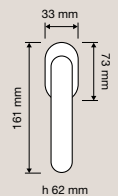

Thais



Finiture / Finishes



CC | Cromo satinato
+ cromo lucido / *Satin
chrome + polished
chrome*



CR | Cromo lucido /
Polished chrome



CS | Cromo satinato /
Satin chrome



OT | Ottone satinato
+ ottone lucido
(non disponibile per
maniglie con rosetta
art.019 e art.024) /
*Satin brass + polished
brass (not available for
door handles on rose
art.019 and art.024)*

Una leggerissima scanalatura,
appena percettibile agli occhi e
sotto il palmo della mano, dona un
sapore piacevolmente insolito a una
collezione che fa della sua semplicità
il suo punto di forza.

*A thin groove that is barely visible
to the eye and is barely perceptible
under the hand, gives an unusual but
pleasant touch to a collection whose
strong point lies in its simplicity.*

Collezione / Collection

1155 RB 019
Maniglia con rosetta
art.019 / Door handle
on rose art.019

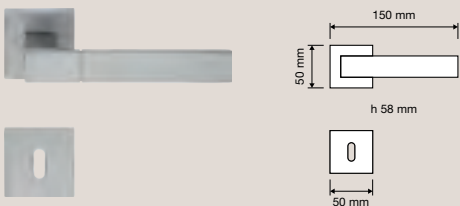

1155 RB 024
Maniglia con rosetta
art.024 / Door
handle on rose
art.024

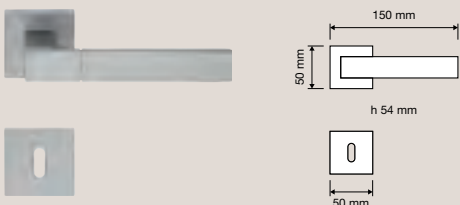

1155 RB 088
Maniglia con rosetta
art.088 / Door
handle on rose
art.088

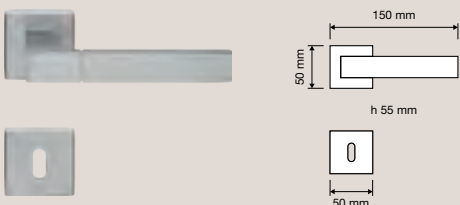

1150 PL
Maniglia con placca
art.1104 / Door
handle on plate
art.1104

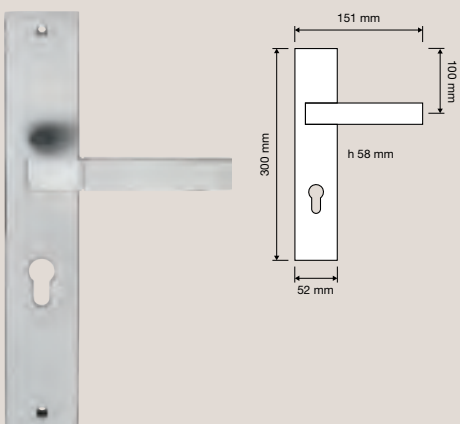

1155 DK
Maniglia per finestra
con movimento DK 4
posizioni / Window
handle with DK
movement 4 clicks



1155 SK
Maniglia per finestra
con movimento
DK SmartBlock /
Window handle
with DK SmartBlock
movement

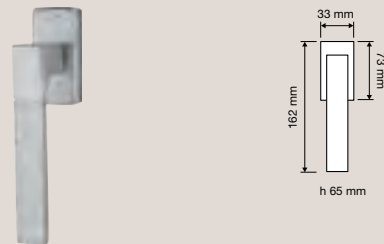

1155 MN 282
Maniglione / Pull
handle

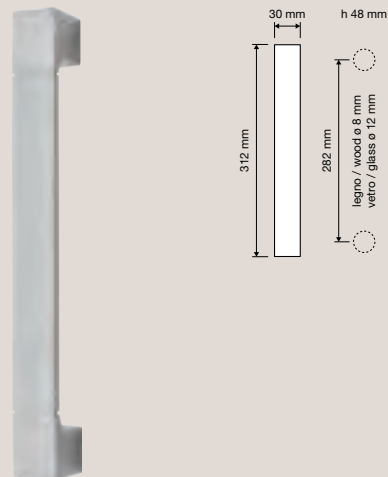

Trendy —



La semplicità delle forme raggiunge l'espressione più elevata in questa collezione che si distingue per la sua estrema leggerezza del design, risultando così un complemento d'arredo passe-partout.

The simplicity of forms reaches its highest expression in this collection that is distinguished by the extreme lightness of its design, making it a passe-partout accessory.

Collezione / Collection

Finiture / Finishes



CR | Cromo lucido /
Polished chrome



CS | Cromo satinato /
Satin chrome



OL | Ottone lucido
verniciato (non
disponibile per
maniglie con rosetta
art.019 e art.024) /
Polished brass (not
available for door
handles on rose
art.019 and art.024)

980 RB 019
Maniglia con rosetta
art.019 / Door handle
on rose art.019

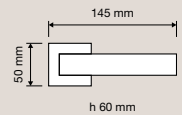

980 RB 024
Maniglia con rosetta
art.024 / Door
handle on rose
art.024

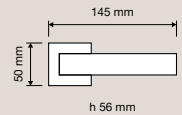

980 RB 102
Maniglia con rosetta
art.102 / Door handle
on rose art.102

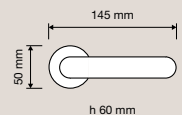

980 DK
Maniglia per finestra
con movimento DK 4
posizioni / Window
handle with DK
movement 4 clicks

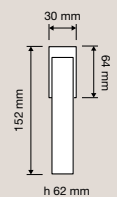

980 SK
Maniglia per finestra
con movimento
DK SmartBlock /
Window handle
with DK SmartBlock
movement

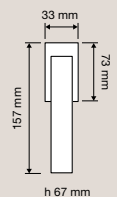

Wind _



Il volume estroflesso dell'impugnatura crea un singolare effetto luce e rende questa collezione un piacevole punto di appoggio visivo.

The extroflexed volume of the handgrip creates a unique light effect and makes this collection a pleasant visual support.

Collezione / Collection

Finiture / Finishes



CR | Cromo lucido /
Polished chrome



CS | Cromo satinato /
Satin chrome



OZ | Oro zecchino /
Gold plated



PM | Patiné / Patiné
mat

1655 RB 023
Maniglia con rosetta
art.023 / Door
handle on rose
art.023

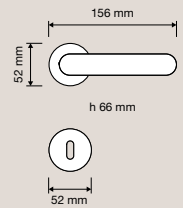

1655 RB 025
Maniglia con rosetta
art.025 / Door
handle on rose
art.025

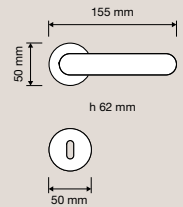

1655 PL
Maniglia con placca /
Door handle on plate

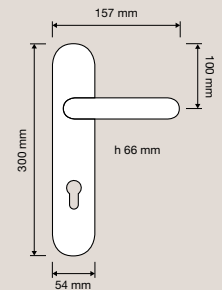

1655 DK
Maniglia per finestra
con movimento DK 4
posizioni / Window
handle with DK
movement 4 clicks

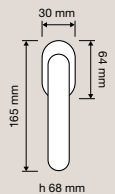

1655 SK
Maniglia per finestra
con movimento
DK SmartBlock /
Window handle
with DK SmartBlock
movement

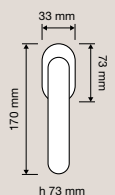

Zen



Finiture / Finishes



CR | Cromo lucido /
Polished chrome



CS | Cromo satinato /
Satin chrome



OL | Ottone lucido
verniciato (non
disponibile per
maniglie con rosetta
art.019 e art.024) /
*Polished brass (not
available for door
handles on rose
art.019 and art.024)*

L'espressione del design moderno è alla base del concept stilistico di questa collezione che si contraddistingue per l'estrema linearità delle forme.

An expression of a linear modern design is the basis for the style concept of this collection that stands out by the extremely linear forms.

Collezione / Collection

1156 RB 019
Maniglia con rosetta
art.019 / Door handle
on rose art.019

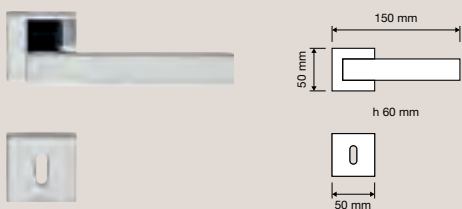

1156 RB 024
Maniglia con rosetta
art.024 / Door
handle on rose
art.024

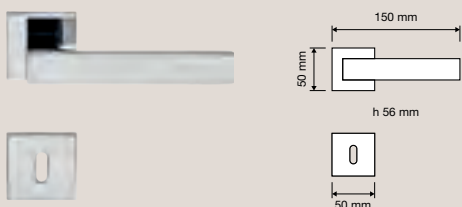

1156 RB 088
Maniglia con rosetta
art.088 / Door
handle on rose
art.088

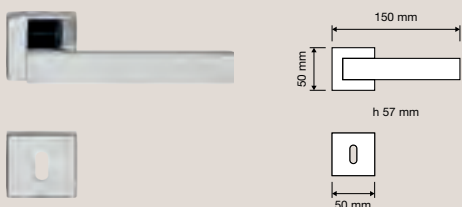

1153 PL
Maniglia con placca
art.1104 / Door
handle on plate
art.1104

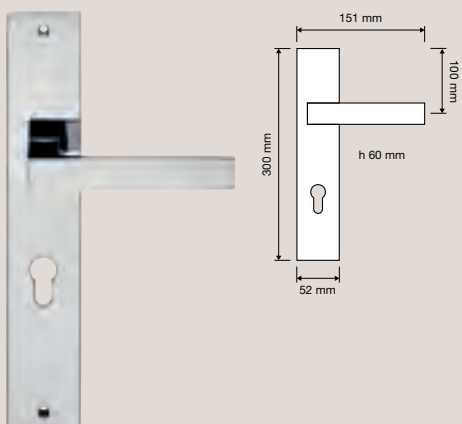

1156 DK
Maniglia per finestra
con movimento DK 4
posizioni / Window
handle with DK
movement 4 clicks

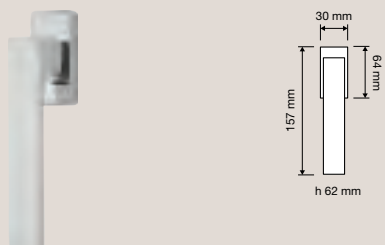

1156 AB
Appendiabiti / Coat
hook



1156 SK
Maniglia per finestra
con movimento
DK SmartBlock /
Window handle
with DK SmartBlock
movement

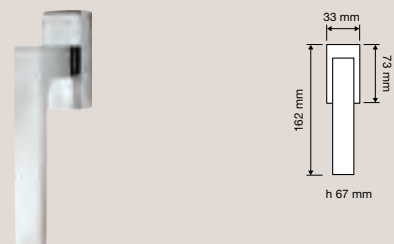

1156 MN 180
Maniglione / Pull
handle

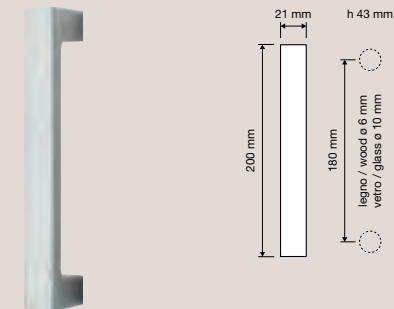

1156 MN 282
Maniglione / Pull
handle

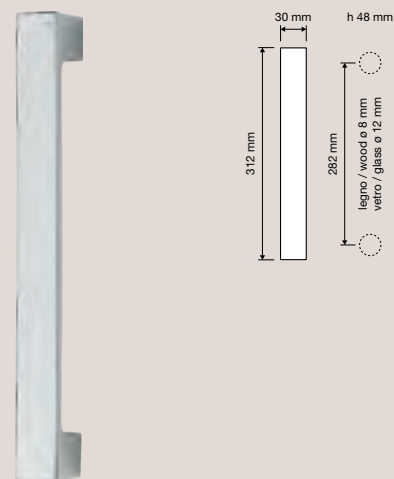

301 FE
Fermaporta / Door
stop



1577 FE
Fermaporta
magnetico quadro
/ Square magnetic
door stop



Zen Fusion —



Due correnti stilistiche, il moderno e lo stile classico più autentico, dialogano e si fondono dando vita a un oggetto che ridefinisce il concetto di contemporaneità.

Two stylistic currents, one modern and the other authentic classic, communicate and blend together giving life to an object that redefines the concept of modernity.

Collezione / Collection

Finiture / Finishes



CC | Cromo satinato +
Cromo lucido / *Satin
chrome + polished
chrome*



CE | Nero opaco +
cromo lucido / *Matt
black + polished
chrome*



CZ | Cromo lucido
+ oro zecchino /
*Polished chrome +
gold plated*



NP | Bronzo opaco +
patiné / *Matt bronze +
patiné mat*

1585 RB 019
Maniglia con rosetta
art.019 / *Door handle
on rose art.019*

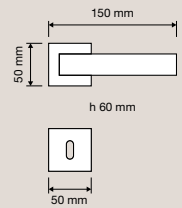

1585 RB 024
Maniglia con rosetta
art.024 / *Door
handle on rose
art.024*

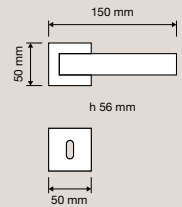

1585 PL
Maniglia con placca
art.1104 / *Door
handle on plate
art.1104*

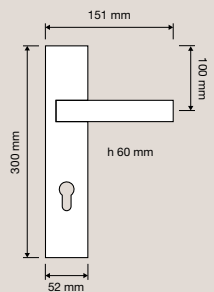

1585 DK
Maniglia per finestra
con movimento DK 4
posizioni / *Window
handle with DK
movement 4 clicks*

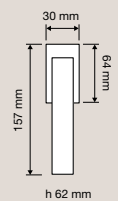

1585 SK
Maniglia per finestra
con movimento
DK SmartBlock /
*Window handle
with DK SmartBlock
movement*

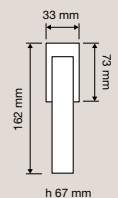

Zen Wengè



Finiture / Finishes



CR | Cromo lucido /
Polished chrome



CS | Cromo satinato /
Satin chrome



OZ | Oro zecchino /
Gold plated

La difficile arte della semplicità è descritta nelle linee di questa collezione, impreziosita da un inserto in pregiato legno wengè.

The difficult art of simplicity is described in the lines of this collection, enhanced with an inlay in fine wenge wood.

Collezione / Collection

1158 RB 019
Maniglia con rosetta
art.019 / Door handle
on rose art.019



1158 RB 024
Maniglia con rosetta
art.024 / Door
handle on rose
art.024

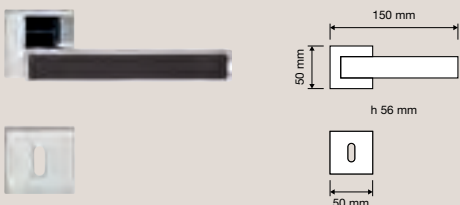

1152 PL
Maniglia con placca
art.1104 / Door
handle on plate
art.1104

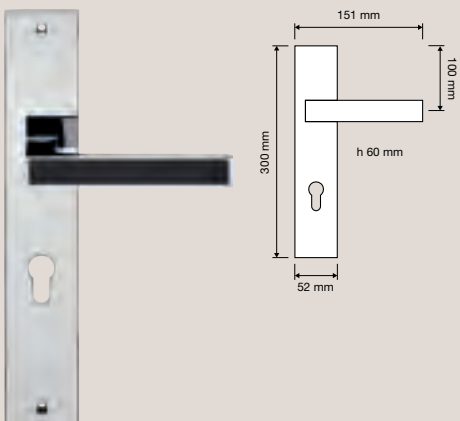

1158 DK
Maniglia per finestra
con movimento DK 4
posizioni / Window
handle with DK
movement 4 clicks

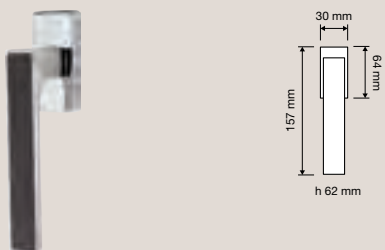

1158 SK
Maniglia per finestra
con movimento
DK SmartBlock /
Window handle
with DK SmartBlock
movement

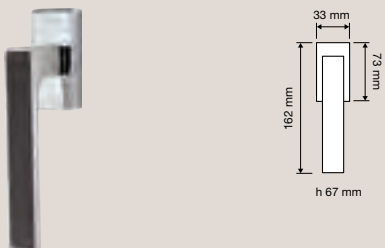

1158 MN 282
Maniglione / Pull
handle

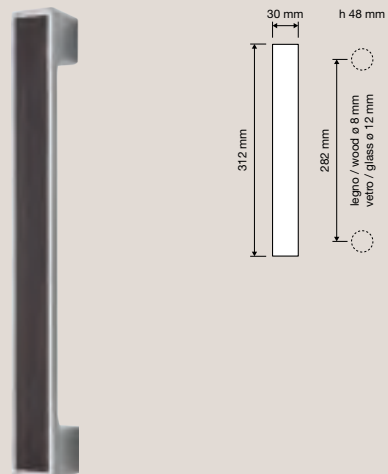

Classico *Classic*



Aldar —



Le forme morbide e gentili donano un tocco classico e piacevolmente femminile ad ogni ambiente.

The soft and gentle forms give a classical and pleasantly feminine touch to all surroundings.

Finiture / Finishes



AN | Ottone
invecchiato / Aged
brass



OG | Ottone bronzato
graffiato / Bronzed
brass



OL | Ottone lucido
verniciato / Polished
brass



OM | Oro sabbato
+ oro / Matt gold +
polished gold

Collezione / Collection

920 RB 103
Maniglia con rosetta
art.103 / Door handle
on rose art.103

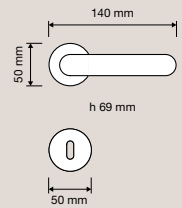

920 MA
Maniglia per finestra
martellina quadro
7mm / Window
handle 7mm square

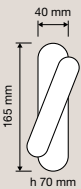

920 DK
Maniglia per finestra
con movimento DK 4
posizioni / Window
handle with DK
movement 4 clicks

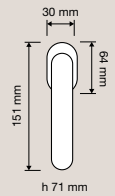

920 SK
Maniglia per finestra
con movimento
DK SmartBlock /
Window handle
with DK SmartBlock
movement

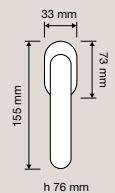

920 MN 218 103
Maniglione con
rosette art.103 /
Pull handle on roses
art.103

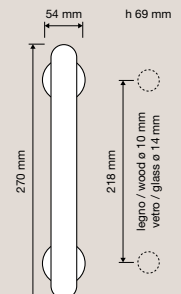

Aria —



Uno statico blocco di ottone si trasforma in un oggetto caratterizzato da un'anima piacevolmente romantica e da un forte dinamismo delle linee.

A static piece of brass is transformed into an object by a pleasantly romantic soul and dynamic lines.

Finiture / Finishes



BM | Bronzo opaco /
Matt bronze



CR | Cromo lucido /
Polished chrome



CS | Cromo satinato /
Satin chrome



OL | Ottone lucido
verniciato / Polished
brass



OZ | Oro zecchino /
Gold plated



PM | Patiné / Patiné
mat

Collezione / Collection

1630 RB 011
Maniglia con rosetta
art.011 / Door handle
on rose art.011

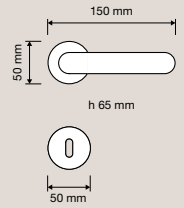

1630 PL
Maniglia con placca /
Door handle on plate

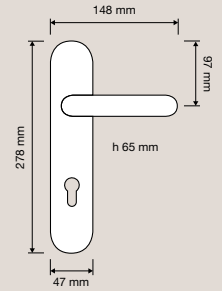

1630 DK
Maniglia per finestra
con movimento DK 4
posizioni / Window
handle with DK
movement 4 clicks

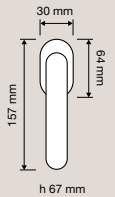

1630 SK
Maniglia per finestra
con movimento
DK SmartBlock /
Window handle
with DK SmartBlock
movement

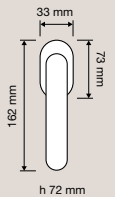

Beta —



Il gusto semplice e romantico di un tempo è riletto in chiave moderna in questa collezione contraddistinta da linee semplici e dolci.

The simple and romantic flavour of times gone by is reinterpreted in modern vein by this collection distinguished by simple and soft lines.

Collezione / Collection

Finiture / Finishes



AN | Ottone invecchiato / Aged brass



CR | Cromo lucido / Polished chrome



CS | Cromo satinato / Satin chrome



OL | Ottone lucido verniciato / Polished brass



PM | Patiné / Patiné mat

488 RB 011
Maniglia con rosetta
art.011 / Door handle
on rose art.011

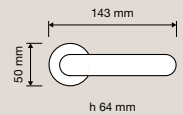

488 RB 027
Maniglia con rosetta
art.027 / Door
handle on rose
art.027

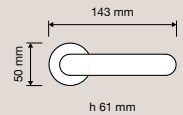

488 PL
Maniglia con placca /
Door handle on plate

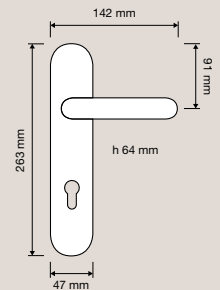

488 DK
Maniglia per finestra
con movimento DK 4
posizioni / Window
handle with DK
movement 4 clicks

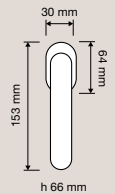

488 SK
Maniglia per finestra
con movimento
DK SmartBlock /
Window handle
with DK SmartBlock
movement

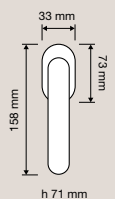

Dafne



Finiture / Finishes



CR | Cromo lucido /
Polished chrome



CS | Cromo satinato /
Satin chrome



OL | Ottone lucido
verniciato (non
disponibile per
maniglie con rosetta
art.019 e art.024) /
*Polished brass (not
available for door
handles on rose
art.019 and art.024)*



PM | Patiné / *Patiné
mat*

La complessità del design si esplicita
in una silhouette semplice ma insolita
che ridefinisce il concetto di classico.

*The complexity of the design is
expressed in a simple yet unusual
silhouette that redefines the concept
of classic designs.*

Collezione / Collection

509 RB 019
Maniglia con rosetta
art.019 / Door handle
on rose art.019

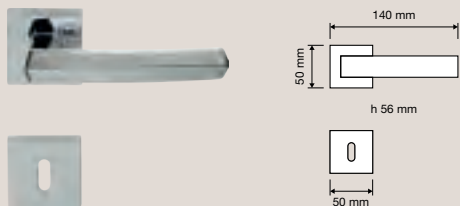

509 RB 024
Maniglia con rosetta
art.024 / Door
handle on rose
art.024

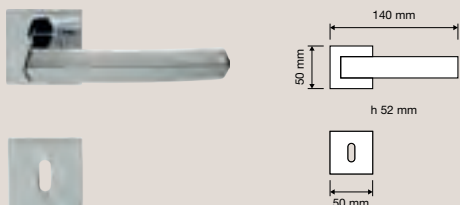

509 RB 102
Maniglia con rosetta
art.102 / Door handle
on rose art.102

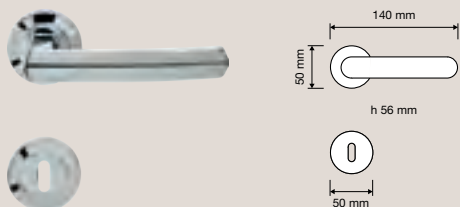

509 PL
Maniglia con placca /
Door handle on plate

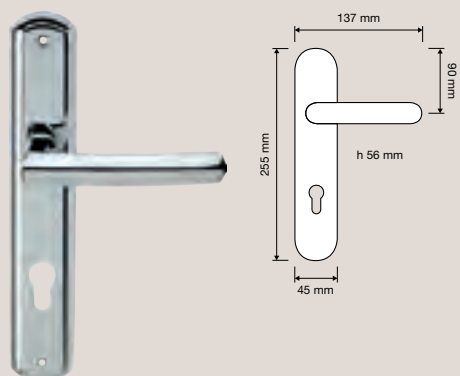

509 DK
Maniglia per finestra
con movimento DK 4
posizioni / Window
handle with DK
movement 4 clicks



509 SK
Maniglia per finestra
con movimento
DK SmartBlock /
Window handle
with DK SmartBlock
movement



Dalia —



Un viaggio oltre il tempo e le mode, un classico della maniglieria che seduce con le sue forme classiche e gentili.

A journey beyond time and trends, a classic Italian handle that seduces with its classic and gentle shapes.

Collezione / Collection

Finiture / Finishes



AN | Ottone invecchiato /
Aged brass



BM | Bronzo opaco /
Matt bronze



CR | Cromo lucido /
Polished chrome



CS | Cromo satinato /
Satin chrome



FV | Ferro effetto
invecchiato / Aged
iron (brass)



OG | Ottone bronzato
graffiato / Bronzed
brass



OL | Ottone lucido
verniciato / Polished
brass

Porcellana / Porcelain



PA 602 | Avorio / Ivory



AM 665 | Avorio fiore
marrone / Brown
flowered ivory



AR 766 | Avorio fiore
rosa / Pink rose
flowered ivory



PB 600 | Bianca /
White porcelain



BB 661 | Bianca
fiore blu / Blue rose
flowered white



BR 660 | Bianca
fiore rosa / Pink rose
flowered white



DENIM 606 | Denim /
Denim



PAMAC 605 |
Porcellana maculata /
Spotted porcelain

600 RB 103
Maniglia con rosetta
art.103 / Door handle
on roses art.103

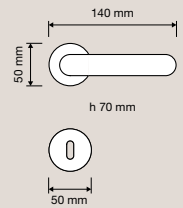

600 PL
Maniglia con placca /
Door handle on plate

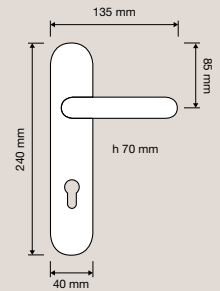
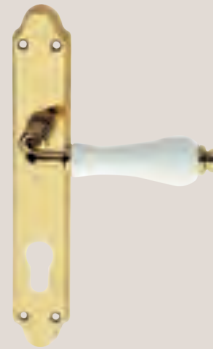

600 CR
Cremonese /
Window handle gratz

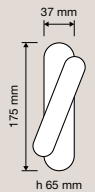

600 MX
Maniglia per finestra
export quadro 7mm
/ Window handle
export 7mm square

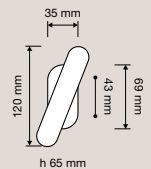

600 DK
Maniglia per finestra
con movimento DK 4
posizioni / Window
handle with DK
movement 4 clicks

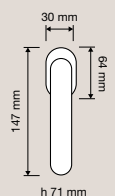

Collezione / Collection

600 SK
Maniglia per finestra
con movimento
DK SmartBlock /
Window handle
with DK SmartBlock
movement

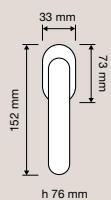

600 MN 218 103
Maniglione con
rosette art.103 /
Pull handle on roses
art.103

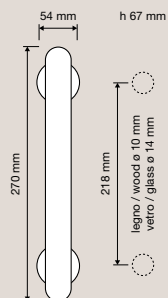



La preziosa impugnatura in porcellana della collezione Dalia è disponibile in numerose fantasie e colori. Degne di nota sono le numerose varianti floreali (fiore rosa, fiore marrone e fiore blu).

The precious porcelain handgrip of the Dalia collection is available in numerous patterns and colours. The numerous floral variations are also worthy of note (pink flower, brown flower and blue flower).

Delfino



Finiture / Finishes



BM | Bronzo opaco /
Matt bronze



CS | Cromo satinato /
Satin chrome



MC | Cromo sabbato
+ cromo lucido / *Matt
chrome + polished
chrome*



OL | Ottone lucido
verniciato / *Polished
brass*



OM | Oro sabbato
+ oro / *Matt gold +
polished gold*

Linee fluide scivolano fra le dita e danno vita a una forma particolare che discende dall'ambiente marino e che suscita curiosità.

Flowing lines glide beneath our fingers and give life to a particular shape that originates in the marine environment and arouses our curiosity.

Collezione / Collection

955 RB 102
Maniglia con rosetta
art.102 / Door handle
on rose art.102

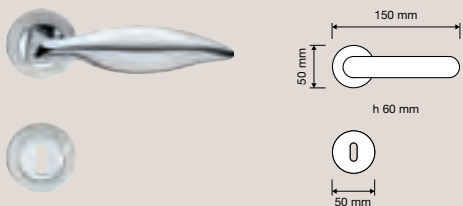

955 PT
Pomolo a tirare /
Fixed knob



955 PL
Maniglia con placca /
Door handle on plate

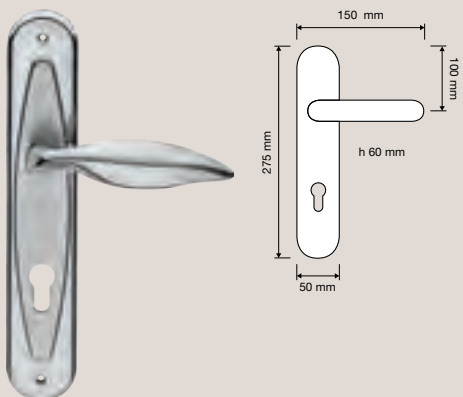

955 PG 102
Pomolo a girare
con rosetta art.102
/ Turnable knob on
rose art.102

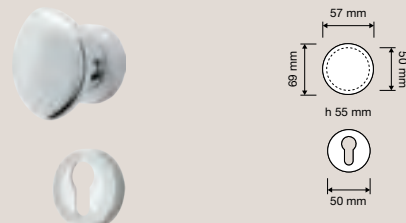

955 CR
Cremonese /
Window handle gratz



955 MN 240
Maniglione / Pull
handle

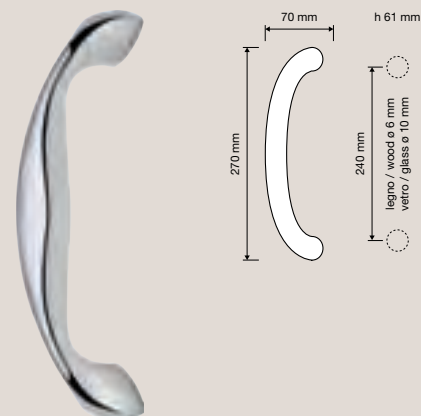

955 DK
Maniglia per finestra
con movimento DK 4
posizioni / Window
handle with DK
movement 4 clicks

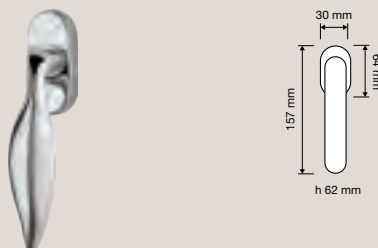

955 SK
Maniglia per finestra
con movimento
DK SmartBlock /
Window handle
with DK SmartBlock
movement

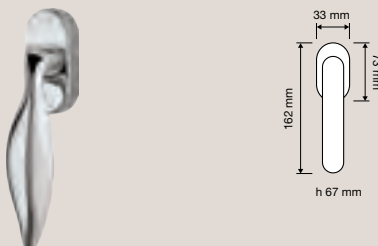

Elika



Finiture / Finishes



BM | Bronzo opaco /
Matt bronze



MC | Cromo sabbato
+ cromo lucido / *Matt
chrome + polished
chrome*



OM | Oro sabbato
+ oro / *Matt gold +
polished gold*

Linee sfuggenti donano un'inaspettata dinamicità a questa maniglia, resa ancor più attraente dall'abbinamento insolito delle finiture che ne esaltano le forme.

Elusive lines give this collection an unexpected vitality, made even more attractive by the unusual combination of finishes that enhance the shape.

Collezione / Collection

990 RB 108
Maniglia con rosetta
art.108 / Door handle
on rose art.108

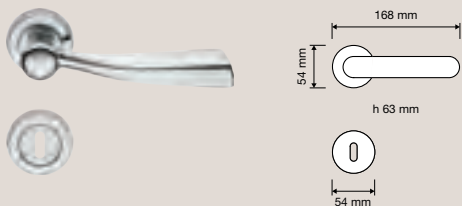

990 PT 060
Pomolo a tirare /
Fixed knob



990 PL
Maniglia con placca /
Door handle on plate

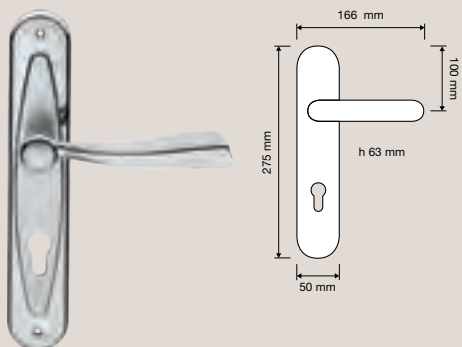

990 PG 108
Pomolo a girare
con rosetta art.108
/ Turnable knob on
rose art.108

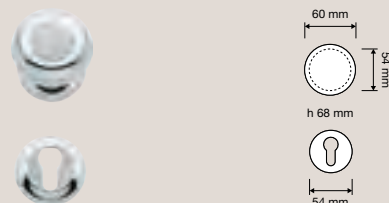

990 CR
Cremonese /
Window handle gratz



990 MN 275 108
Maniglione con
rosette art.108 /
Pull handle on roses
art.108

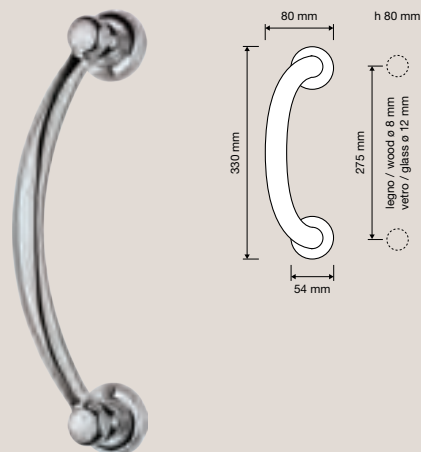

990 DK
Maniglia per finestra
con movimento DK 4
posizioni / Window
handle with DK
movement 4 clicks

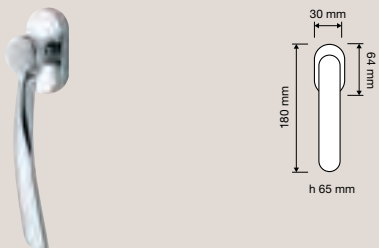

990 BA
Battente / Door
knocker

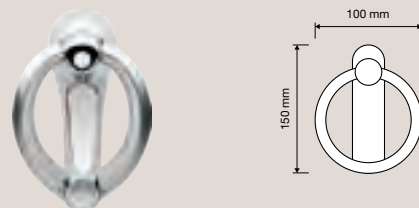

990 SK
Maniglia per finestra
con movimento
DK SmartBlock /
Window handle
with DK SmartBlock
movement

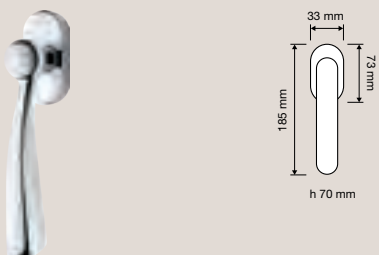

Erica —



L'attualissimo stile shabby-chic, che combina il provenzale al british e retrò, vede come ideale complemento d'arredo questa collezione dalle forme piacevolmente femminili.

The recent shabby-chic style, that combines the Provencal style with the British retro style, makes this collection with pleasantly feminine forms the ideal furnishing accessory.

Finiture / Finishes



AN | Ottone invecchiato / Aged brass



BM | Bronzo opaco / Matt bronze



FV | Ferro effetto invecchiato / Aged iron (brass)



OG | Ottone bronzato graffiato / Bronzed brass



OL | Ottone lucido verniciato / Polished brass

Porcellana / Porcelain



PB 1295 | Bianca / White

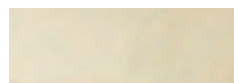

PA 1296 | Avorio / Ivory

Collezione / Collection

1296 RB 103
Maniglia con rosetta
art.103 / Door handle
on rose art.103

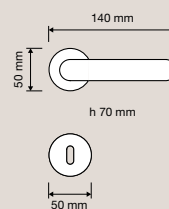

1296 PL
Maniglia con placca /
Door handle on plate

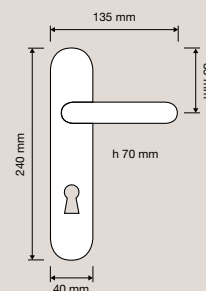

1296 DK
Maniglia per finestra
con movimento DK 4
posizioni / Window
handle with DK
movement 4 clicks

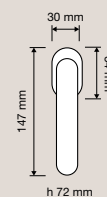

1296 SK
Maniglia per finestra
con movimento
DK SmartBlock /
Window handle
with DK SmartBlock
movement

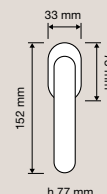

1296 MN 218 103
Maniglione con
rosette art.103 /
Pull handle on roses
art.103

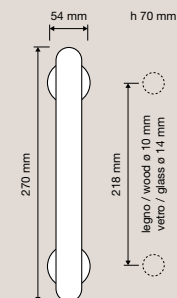

Flavia —

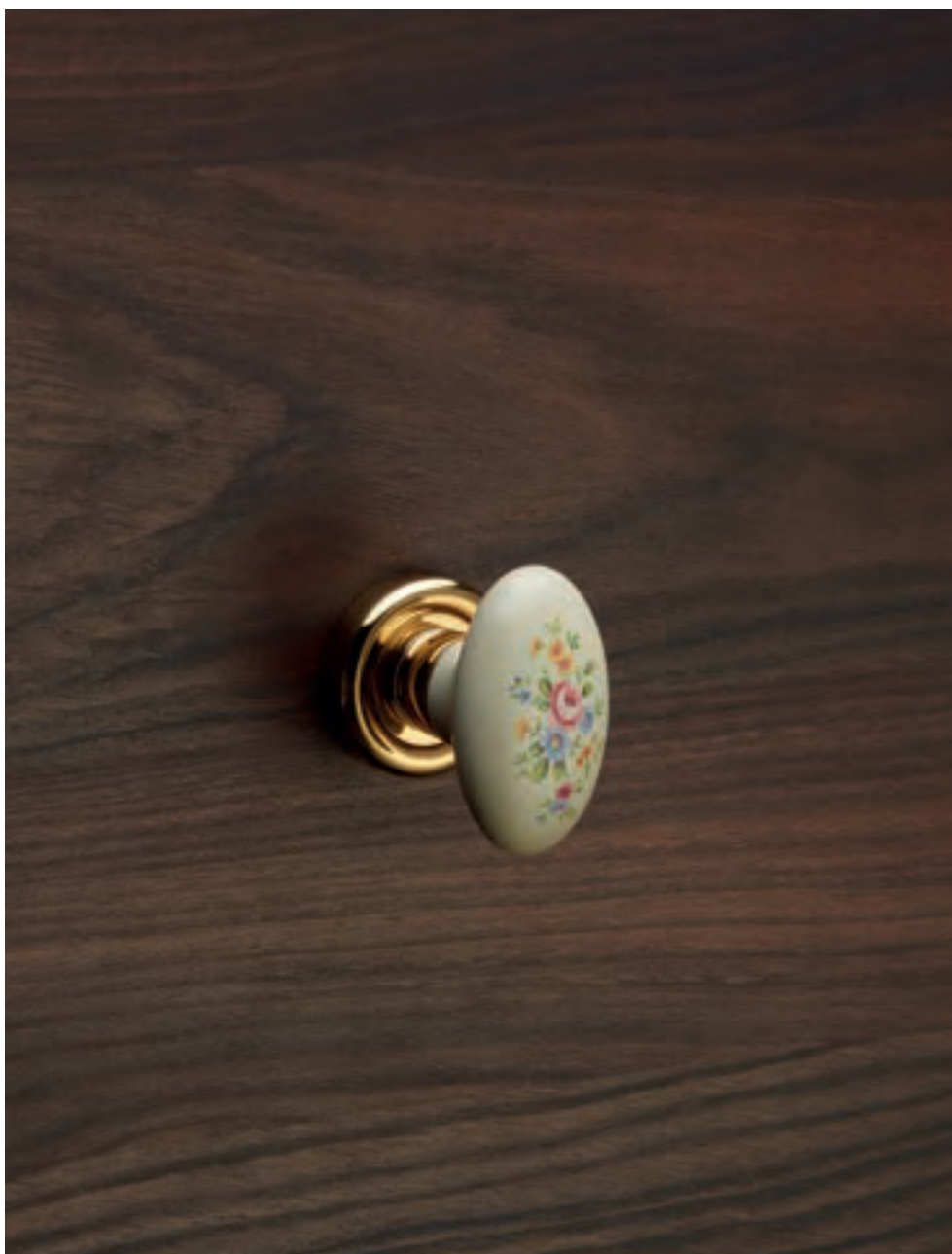

Delicati e raffinati motivi floreali decorano la pregiata porcellana tedesca di questa collezione da un piacevole sapore retrò.

Delicate and refined floral motifs adorn the fine German porcelain that characterises this collection with a pleasantly retro taste.

Finiture / Finishes



AN | Ottone
invecchiato / Aged
brass



BM | Bronzo opaco /
Matt bronze



OG | Ottone bronzato
graffiato / Bronzed
brass



OL | Ottone lucido
verniciato / Polished
brass

Porcellana / Porcelain

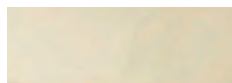

PA 687 | Avorio / Ivory



AM 683 | Avorio fiore
marrone / Brown
flowered ivory



AR 767 | Avorio fiore
rosa / Pink rose
flowered ivory



PB 685 | Bianca /
White



BB 681 | Bianca
fiore blu / Blue rose
flowered white



BR 680 | Bianca
fiore rosa / Pink rose
flowered white



PF 686 | Bianca fiore
margherita / Daisy
flowered white

Collezione / Collection

685 RB 103
Maniglia con rosetta
art.103 / Door handle
on rose art.103

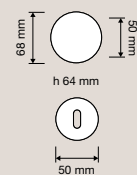
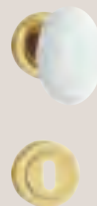

685 CR
Cremonese /
Window handle gratz

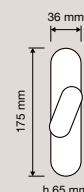

Florenzia



Finiture / Finishes



AN | Ottone
invecchiato / Aged
brass



FV | Ferro effetto
invecchiato / Aged
iron (brass)



PM | Patiné / Patiné
mat



VB | Ottone vibrato /
Vibrated brass

L'atmosfera delle vecchie dimore toscane, d'intonaci usurati e di vecchi pavimenti levigati dal tempo, è evocata da questa collezione dal piacevole sapore d'antan.

The atmosphere of old Tuscan farmhouses with faded plaster and floors that are polished from years of use is evoked by this collection with a pleasant taste of yesteryear.

Collezione / Collection

1460 RB 011
Maniglia con rosetta
art.011 / Door handle
on rose art.011

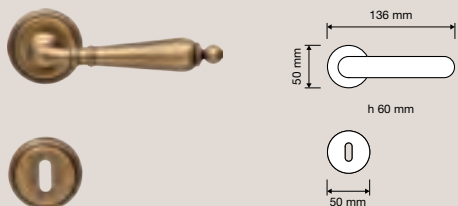

1460 RB 101
Maniglia con rosetta
art.101 / Door handle
on rose art.101

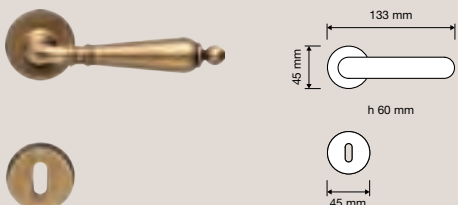

1460 RB 110
Maniglia con rosetta
art.110 / Door handle
on rose art.110

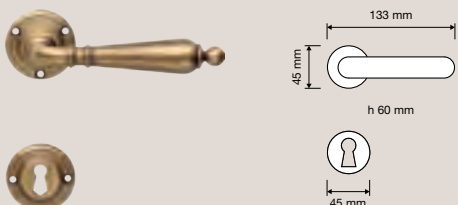

1460 PL
Maniglia con placca /
Door handle on plate

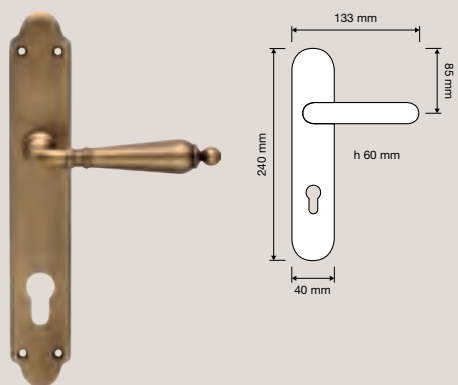

1460 CR
Cremonese /
Window handle gratz



1460 DK
Maniglia per finestra
con movimento DK 4
posizioni / Window
handle with DK
movement 4 clicks

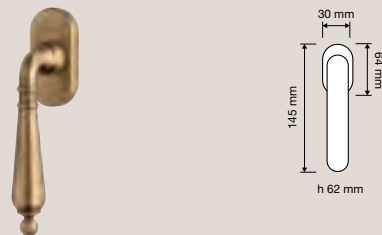

1460 SK
Maniglia per finestra
con movimento
DK SmartBlock /
Window handle
with DK SmartBlock
movement

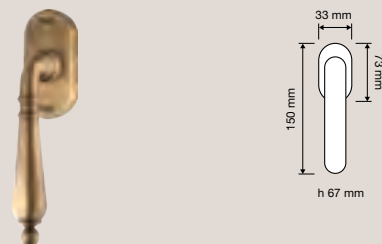

1460 MN 210 101
Maniglione con
rosette art.101 / Pull
handle on roses
art.101

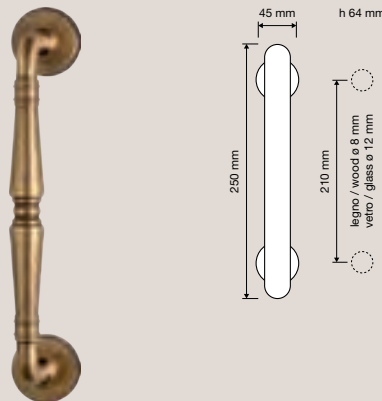

1460 MZ 198 101
Maniglione zancato
con rosette art.101 /
Offset Pull handle on
roses art.101

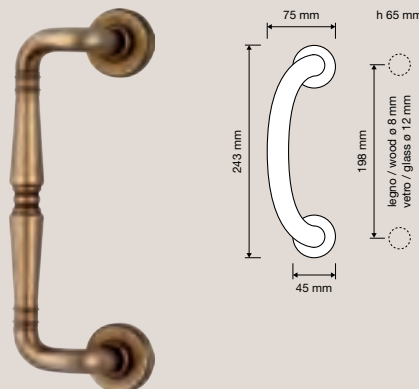

Havana —



Linee curve si rincorrono dando vita a una silhouette estremamente dolce, caratterizzata da un alternarsi di superfici lucide e satinare, che vuole essere un omaggio al famosissimo sigaro cubano.

Curved lines overlap giving life to an extremely soft silhouette, characterised by alternating polished and satin surfaces and which is intended as a homage to the famous Cuban cigar.

Collezione / Collection

Finiture / Finishes



CR | Cromo lucido /
Polished chrome



OL | Ottone lucido
verniciato / Polished
brass



OZ | Oro zecchino /
Gold plated

1080 RB 102
Maniglia con rosetta
art.102 / Door handle
on rose art.102

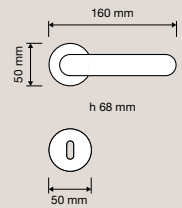

1080 PL
Maniglia con placca /
Door handle on plate

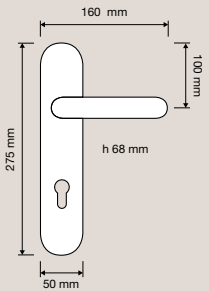

1080 DK
Maniglia per finestra
con movimento DK 4
posizioni / Window
handle with DK
movement 4 clicks

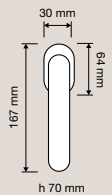

1080 SK
Maniglia per finestra
con movimento
DK SmartBlock /
Window handle
with DK SmartBlock
movement

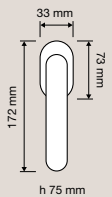

1080 MN 267 102
Maniglione con
rosette art.102 /
Pull handle on roses
art.102

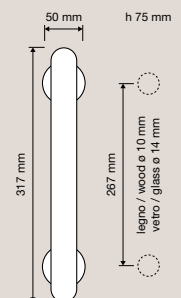

Heidi _



L'amore per lo stile classico in voga nel '900 definisce le linee di questa elegante collezione di maniglie, nata con l'intento di completare l'interior design delle dimore più esclusive ed elitarie.

The love for the classical style in vogue in the 1900s defines the lines of this elegant collection of handles, created with the aim of completing the interior design of the most exclusive and elite homes.

Collezione / Collection

Finiture / Finishes



CR | Cromo lucido /
Polished chrome



CS | Cromo satinato /
Satin chrome



FV | Ferro effetto
invecchiato / Aged
iron (brass)



OL | Ottone lucido
verniciato / Polished
brass



PM | Patiné / Patiné
mat



VE | Nero opaco / Matt
black

1665 RB 011
Maniglia con rosetta
art.011 / Door handle
on rose art.011

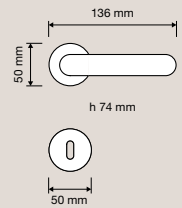

1665 RB 027
Maniglia con rosetta
art.027 / Door handle
on rose art.027

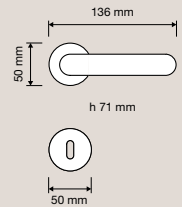

1665 PL
Maniglia con placca /
Door handle on plate

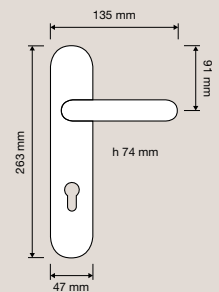
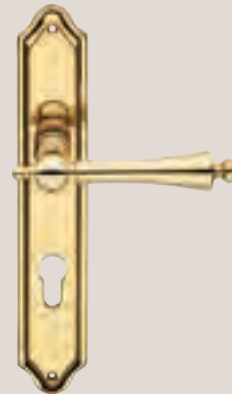

1665 DK
Maniglia per finestra
con movimento DK 4
posizioni / Window
handle with DK
movement 4 clicks

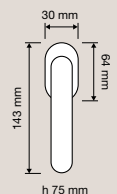

1665 SK
Maniglia per finestra
con movimento
DK SmartBlock /
Window handle
with DK SmartBlock
movement

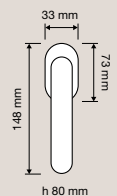

Karina _



L'essenzialità del design e la ricerca della funzionalità si incontrano nella collezione di maniglie Karina, dando vita a un oggetto pratico contraddistinto da un design piacevole e originale.

An essential design and the search for functionality are combined in the Karina collection of handles, giving life to a practical object distinguished by a pleasant and original design.

Finiture / Finishes



CE | Nero opaco +
cromo lucido / *Matt
black + polished
chrome*



CN | Nickel satinato +
cromo lucido / *Satin
nickel + polished
chrome*



OT | Ottone satinato +
ottone lucido / *Satin
brass + polished
brass*

Collezione / Collection

940 RB 102
Maniglia con rosetta
art.102 / *Door handle
on rose art.102*

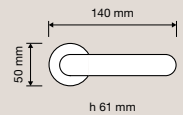

940 PL
Maniglia con placca /
Door handle on plate

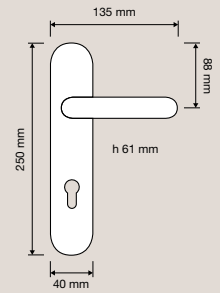

940 DK
Maniglia per finestra
con movimento DK 4
posizioni / *Window
handle with DK
movement 4 clicks*

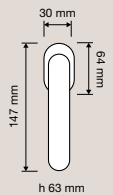

940 SK
Maniglia per finestra
con movimento
DK SmartBlock /
*Window handle
with DK SmartBlock
movement*

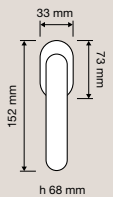

940 MN 203 102
Maniglione con
rosette art.102 /
*Pull handle on roses
art.102*

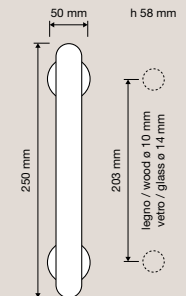

Kuba —



Forme importanti, caratterizzate da linee morbide e dolci, rendono questa collezione insolita e facile da abbinare a ogni ambiente.

Imposing shapes, characterised by soft and gentle lines, make this an unusual and fun collection. An interesting and particular style.

Finiture / Finishes



CR | Cromo lucido /
Polished chrome



CS | Cromo satinato /
Satin chrome



NS | Nickel satinato /
Satin nickel



OL | Ottone lucido
verniciato / Polished
brass



OZ | Oro zecchino /
Gold plated

Collezione / Collection

930 RB 103
Maniglia con rosetta
art.103 / Door handle
on rose art.103

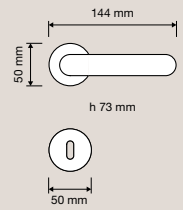

930 PL
Maniglia con placca /
Door handle on plate

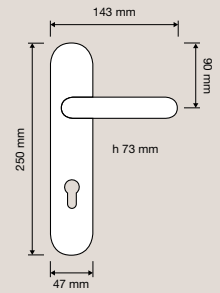

930 DK
Maniglia per finestra
con movimento DK 4
posizioni / Window
handle with DK
movement 4 clicks

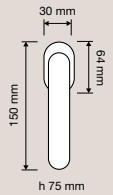

930 SK
Maniglia per finestra
con movimento
DK SmartBlock /
Window handle
with DK SmartBlock
movement

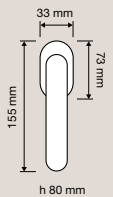

Kuba Pomolo _



Una forma naturale, materica,
che ricorda una pietra modellata
dall'acqua e che risulta estremamente
piacevole da impugnare.

*A natural and material form, that
recalls a stone that has been
modelled by water and is extremely
pleasant to hold.*

Collezione / Collection

Finiture / Finishes



CR | Cromo lucido /
Polished chrome



CS | Cromo satinato /
Satin chrome



NS | Nickel satinato /
Satin nickel



OL | Ottone lucido
verniciato / *Polished
brass*



PV | Titanio / *Titanium*

936 RB 103
Maniglia con rosetta
art.103 / *Door handle
on rose art.103*

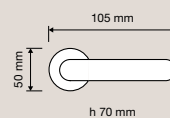

Lady —

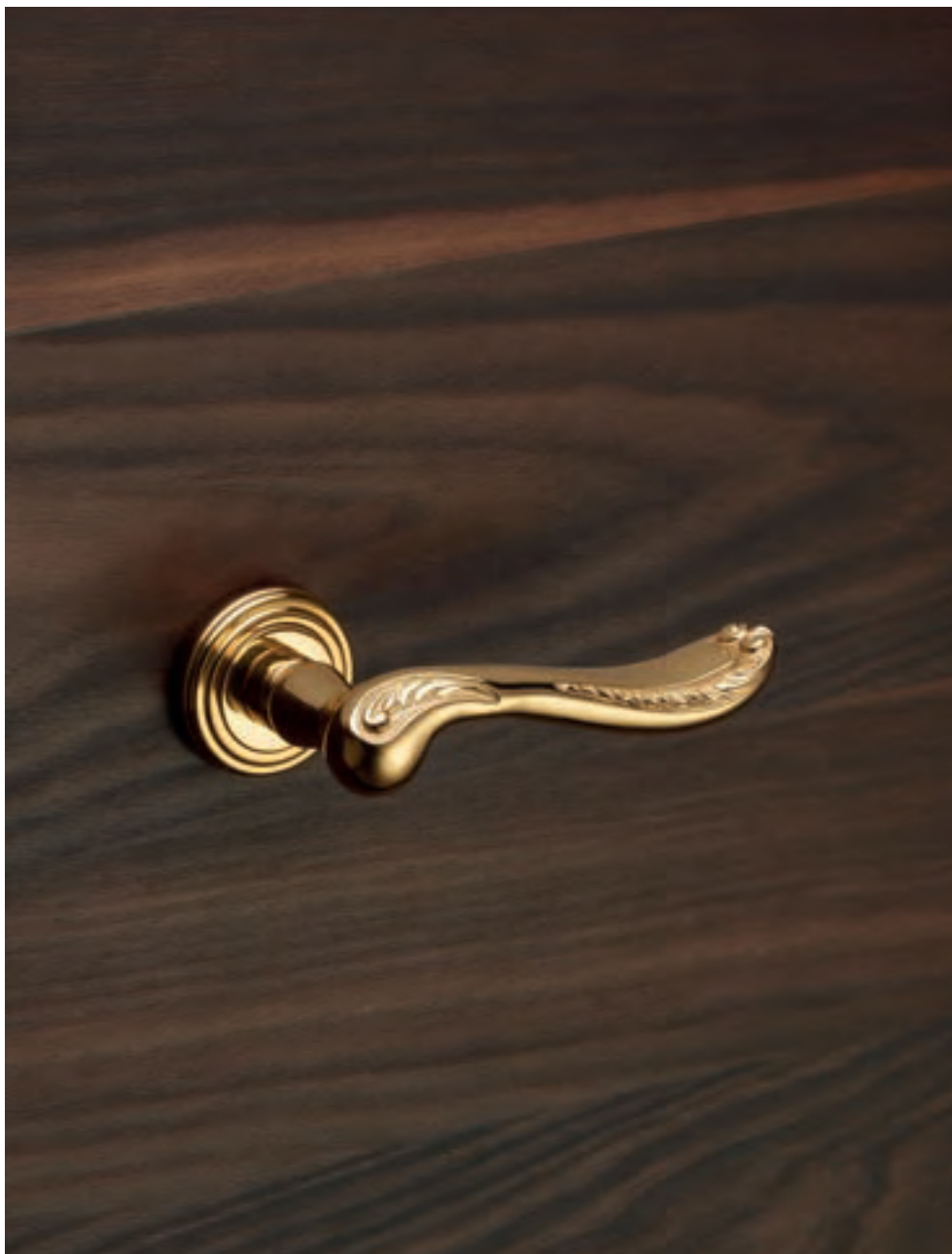

Finiture / Finishes



BO | Bronzo sfumato
opaco / *Bronze*



OF | Oro francese /
French gold



OZ | Oro zecchino /
Gold plated



PM | Patiné / *Patiné
mat*

Una collezione di maniglie classica e
“intramontabile”, nata non per stupire
ma per adattarsi a ogni ambiente con
grande eleganza.

*A classic and “timeless” collection of
handles not created to impress but to
fit in elegantly with all surroundings.*

Collezione / Collection

1390 RB 011
Maniglia con rosetta
art.011 / Door handle
on rose art.011

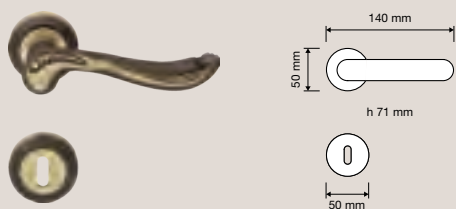

1390 PL
Maniglia con placca /
Door handle on plate

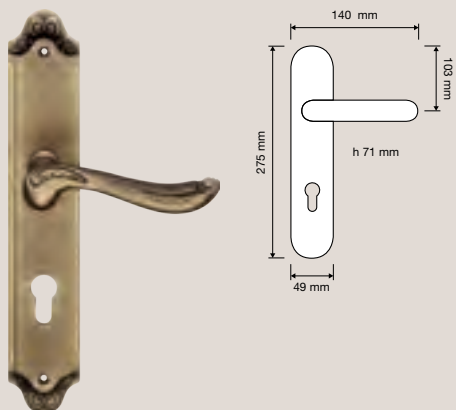

1390 DK
Maniglia per finestra
con movimento DK 4
posizioni / Window
handle with DK
movement 4 clicks



1390 SK
Maniglia per finestra
con movimento
DK SmartBlock /
Window handle
with DK SmartBlock
movement

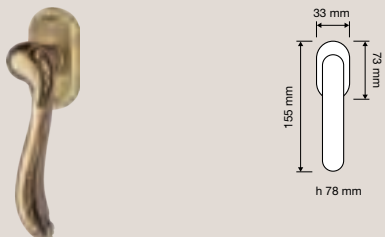

1390 MN 155
Maniglione / Pull
handle

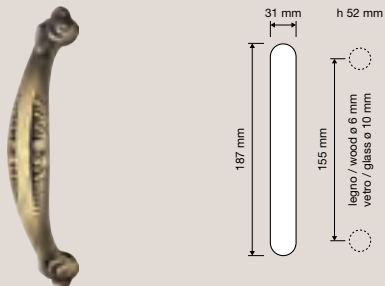

1390 SL
Maniglione su placca
/ Pull handle on plate

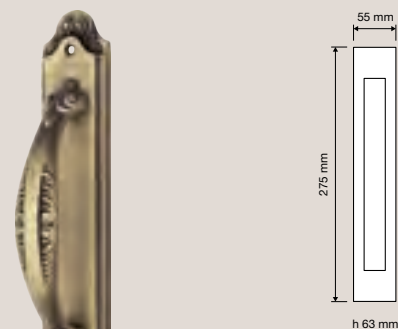

1390 IP
Placca incasso su
placca / Flush pull on
plate

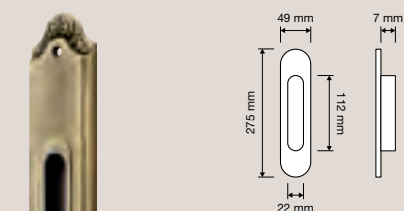

Libera —

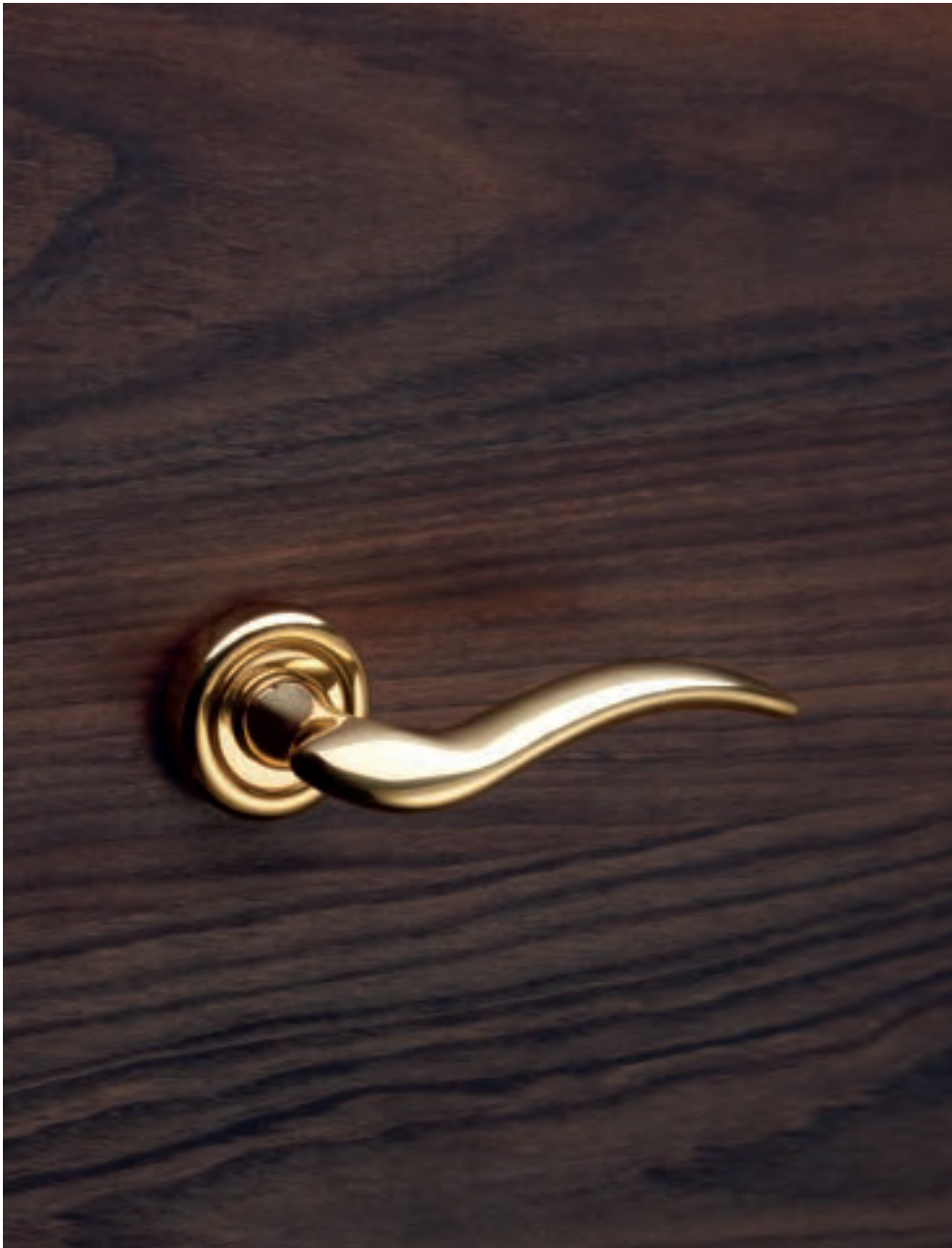

La sensazione di libertà è chiara ed evidente nelle forme che sembrano essere modellate dal vento.

The sensation of liberty is clear and evident in the forms that seem to have been shaped by the wind.

Collezione / Collection

Finiture / Finishes



BM | Bronzo opaco /
Matt bronze



NS | Nickel satinato /
Satin nickel



OG | Ottone bronzato
graffiato / Bronzed
brass



OL | Ottone lucido
verniciato / Polished
brass



OS | Ottone satinato /
Satin brass

981 RB 103
Maniglia con rosetta
art.103 / Door handle
on rose art.103

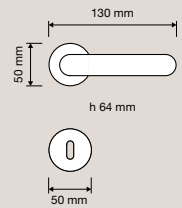

981 PL
Maniglia con placca /
Door handle on plate

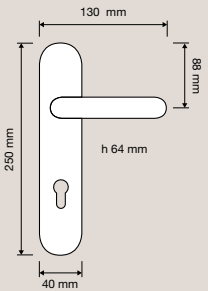

981 CR
Cremonese /
Window handle gratz

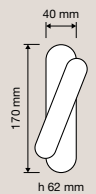

981 DK
Maniglia per finestra
con movimento DK 4
posizioni / Window
handle with DK
movement 4 clicks

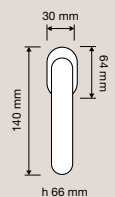

981 SK
Maniglia per finestra
con movimento
DK SmartBlock /
Window handle
with DK SmartBlock
movement

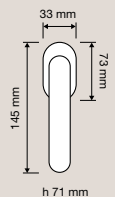

Marina



Finiture / Finishes



BM | Bronzo opaco /
Matt bronze



CR | Cromo lucido /
Polished chrome



CS | Cromo satinato /
Satin chrome



OL | Ottone lucido
verniciato / *Polished
brass*



PM | Patiné / *Patiné
mat*

L'impugnatura stratificata movimentata il design di questa collezione dando vita a una silhouette classica ma piacevolmente originale.

The layered handle enlivens the design of this collection, giving life to a classic but pleasantly original silhouette.

Collezione / Collection

755 RB 102
Maniglia con rosetta
art.102 / Door handle
on rose art.102

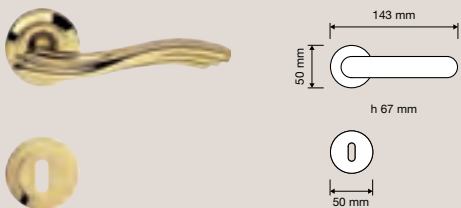

755 PL
Maniglia con placca
art.750 / Door
handle on plate
art.750

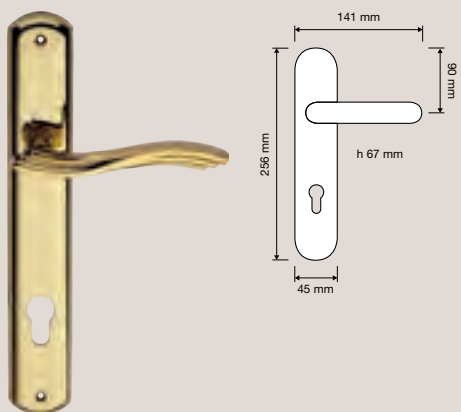

755 DK
Maniglia per finestra
con movimento DK 4
posizioni / Window
handle with DK
movement 4 clicks

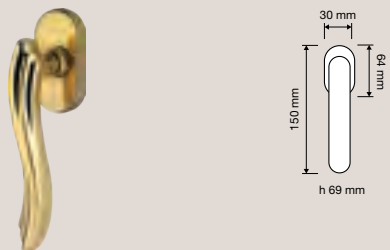

755 SK
Maniglia per finestra
con movimento
DK SmartBlock /
Window handle
with DK SmartBlock
movement

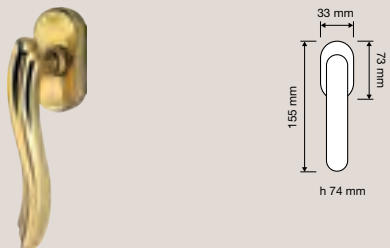

755 MN 320
Maniglione / Pull
handle

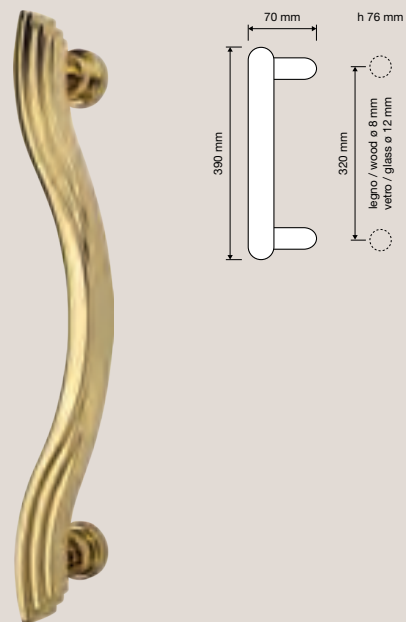

Nota _



Una rilettura in chiave moderna di una melodia classica, caratterizzata dalla particolarissima impugnatura a forma di nota che rende questa collezione allegra e divertente.

A modern reinterpretation of a classic melody, characterized by the very unusual handgrip in the form of a musical note making this a cheerful and fun collection.

Finiture / Finishes



CR | Cromo lucido /
Polished chrome



CS | Cromo satinato /
Satin chrome



OL | Ottone lucido
verniciato / Polished
brass



PM | Patiné / Patiné
mat

Collezione / Collection

1330 RB 103
Maniglia con rosetta
art.103 / Door handle
on rose art.103

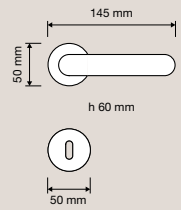

1330 PL
Maniglia con placca /
Door handle on plate

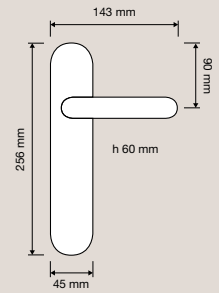

1330 DK
Maniglia per finestra
con movimento DK 4
posizioni / Window
handle with DK
movement 4 clicks

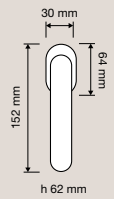

1330 SK
Maniglia per finestra
con movimento
DK SmartBlock /
Window handle
with DK SmartBlock
movement

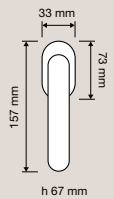

Pin-up —



Una collezione di maniglie in ottone elegante e discreta, forte della sua estrema semplicità.

An elegant and discreet collection of brass handles, drawing upon their extreme simplicity.

Collezione / Collection

Finiture / Finishes



CR | Cromo lucido /
Polished chrome



CS | Cromo satinato /
Satin chrome



NS | Nickel satinato /
Satin nickel



OL | Ottone lucido
verniciato / Polished
brass



OS | Ottone satinato /
Satin brass

925 RB 102
Maniglia con rosetta
art.102 / Door handle
on rose art.102

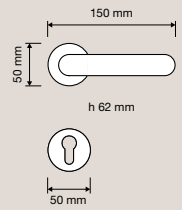

925 PL
Maniglia con placca /
Door handle on plate

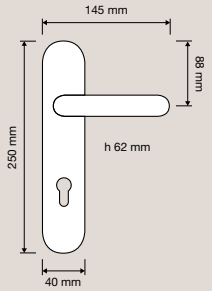

925 DK
Maniglia per finestra
con movimento DK 4
posizioni / Window
handle with DK
movement 4 clicks

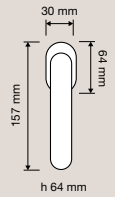

925 SK
Maniglia per finestra
con movimento
DK SmartBlock /
Window handle
with DK SmartBlock
movement

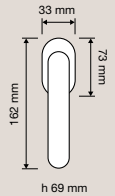

Rose —



Il “sapore” delicato e romantico della rosa Bonica regala un tocco di piacevole femminilità a questa collezione, ideale complemento d’arredo per tutti gli ambienti dal sapore country e shabby-chic.

The delicate and romantic flavour of the Bonica rose gives a touch of pleasant femininity to this collection, the ideal furnishing accessory for all environments with a country and shabby-chic style.

Collezione / Collection

Finiture / Finishes



AN | Ottone
invecchiato / Aged
brass



BM | Bronzo opaco /
Matt bronze



FV | Ferro effetto
invecchiato / Aged
iron (brass)

996 RB 108
Maniglia con rosetta
art.108 / Door handle
on rose art.108

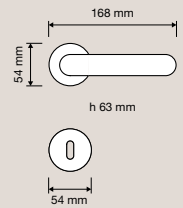
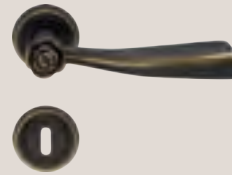

996 PL
Maniglia con placca /
Door handle on plate

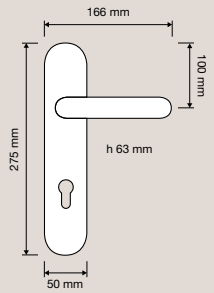

996 CR
Cremonese /
Window handle gratz

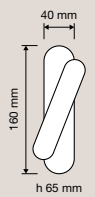

996 DK
Maniglia per finestra
con movimento DK 4
posizioni / Window
handle with DK
movement 4 clicks

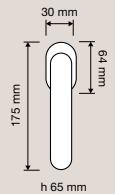

996 SK
Maniglia per finestra
con movimento
DK SmartBlock /
Window handle
with DK SmartBlock
movement

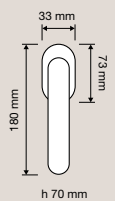

Collezione / Collection

996 PT 065
Pomolo a tirare /
Fixed knob

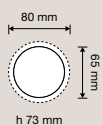

996 PB 0030
Pomolo per mobile /
Cabinet knob

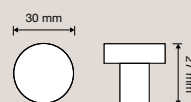

996 PG 108
Pomolo a girare
con rosetta art.108
/ Turnable knob on
rose art.108

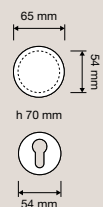

996 MN 275 108
Maniglione con
rosette art.108 /
Pull handle on roses
art.108

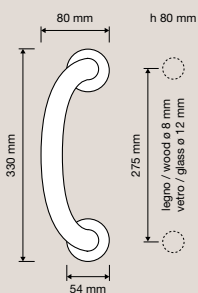

996 KD/KS
Maniglia (dx o sx)
+ pomolo fisso con
placca / Door handle
(right or left) + fixed
knob on plate

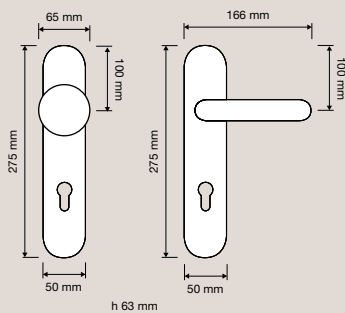

996 BA
Battente / Door
knocker

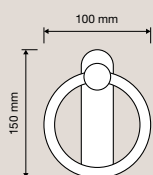



Tess



Finiture / Finishes



CC | Cromo satinato + cromo lucido / *Satin chrome + polished chrome*



OT | Ottone satinato + ottone lucido / *Satin brass + polished brass*

Una collezione estremamente contemporanea, classica ma che strizza l'occhio al design, caratterizzata da uno stile piacevolmente sobrio.

An extremely contemporary collection, classical while winking at design, characterised by a pleasantly sober style.

Collezione / Collection

511 RB 027
Maniglia con rosetta
art.027 / Door
handle on rose
art.027

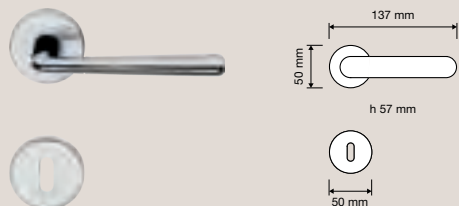

511 RB 088
Maniglia con rosetta
art.088 / Door
handle on rose
art.088

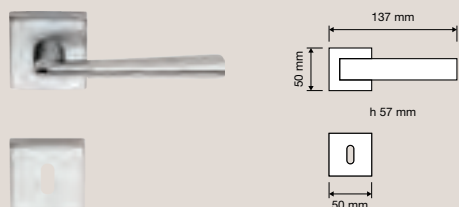

511 RB 102
Maniglia con rosetta
art.102 / Door handle
on rose art.102

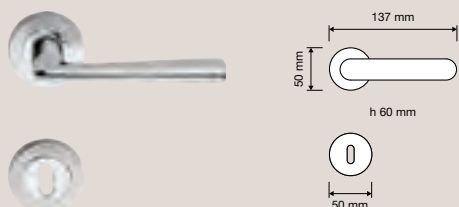

511 PL
Maniglia con placca /
Door handle on plate

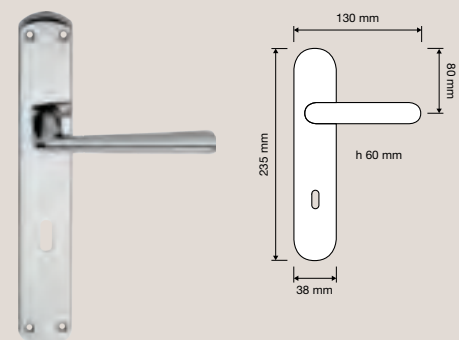

511 CR
Cremonese /
Window handle gratz



511 DK
Maniglia per finestra
con movimento DK 4
posizioni / Window
handle with DK
movement 4 clicks

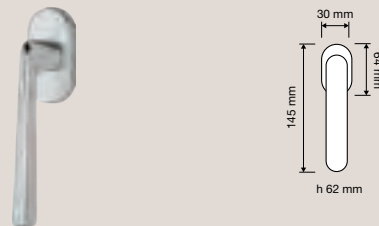

511 SK
Maniglia per finestra
con movimento
DK SmartBlock /
Window handle
with DK SmartBlock
movement

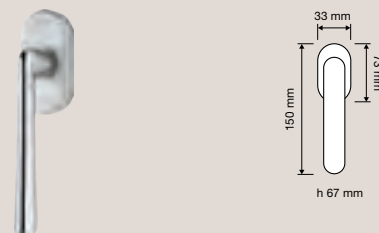

Tosca



Finiture / Finishes



AN | Ottone
invecchiato / *Aged
brass*



BM | Bronzo opaco /
Matt bronze



FV | Ferro effetto
invecchiato / *Aged
iron (brass)*



OL | Ottone lucido
verniciato / *Polished
brass*

Le atmosfere dello stile provenzale, nato nella parte meridionale della Francia fra le Alpi e il mare, donano a questa collezione un "allure" particolarmente romantica.

The atmosphere of the Provençal style, created in the south of France between the Alps and the sea, gives this collection a particularly romantic allure.

Collezione / Collection

745 RB 101
Maniglia con rosetta
art.101 / Door handle
on rose art.101

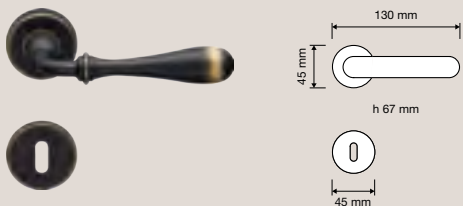

745 RB 110
Maniglia con rosetta
art.110 / Door handle
on rose art.110

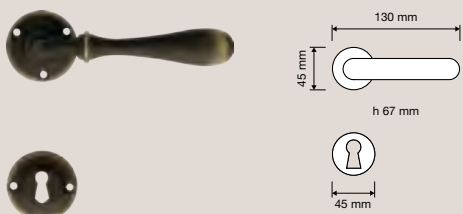

745 PL
Maniglia con placca /
Door handle on plate

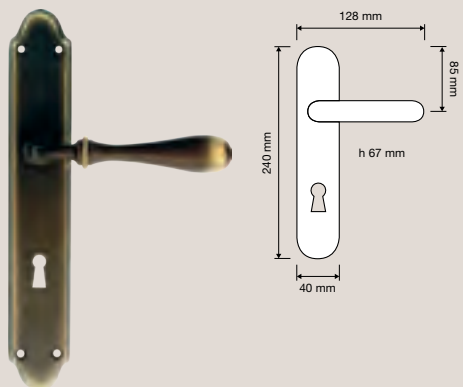

745 CR
Cremonese /
Window handle gratz



745 DK
Maniglia per finestra
con movimento DK 4
posizioni / Window
handle with DK
movement 4 clicks



745 SK
Maniglia per finestra
con movimento
DK SmartBlock /
Window handle
with DK SmartBlock
movement

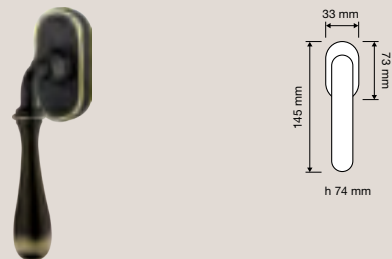

745 MN 158 101
Maniglione con
rosette art.101 / Pull
handle on roses
art.101

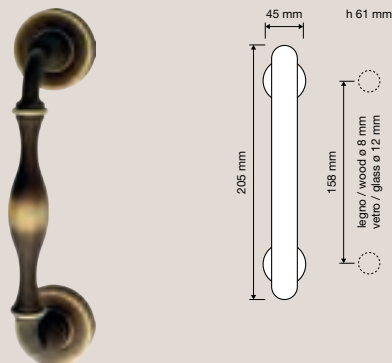

745 MN 225 101
Maniglione con
rosette art.101 / Pull
handle on roses
art.101

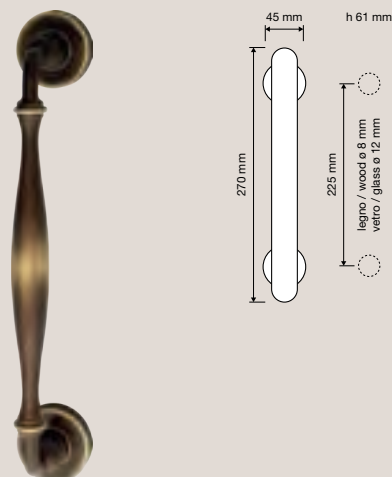





Easy

Brixia —



La bellezza di questa collezione risiede nel suo design pulito e lineare che le permette di “vestire” tutte le tipologie di porte.

The beauty of this collection lies in its clean and linear design making it suitable for all door types.

Collezione / Collection

Finiture / Finishes



CR | Cromo lucido /
Polished chrome



CS | Cromo satinato /
Satin chrome



NS | Nickel satinato /
Satin nickel



OG | Ottone bronzato
graffiato / Bronzed
brass



OL | Ottone lucido
verniciato / Polished
brass



OS | Ottone satinato /
Satin brass

760 RB 101
Maniglia con rosetta
art.101 / Door handle
on rose art.101

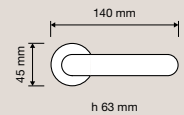

760 RB 102
Maniglia con rosetta
art.102 / Door handle
on rose art.102

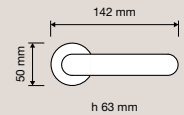

760 PL
Maniglia con placca /
Door handle on plate

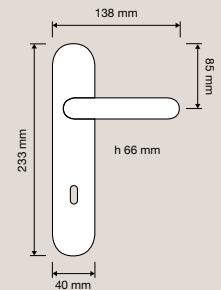

760 DK
Maniglia per finestra
con movimento DK 4
posizioni / Window
handle with DK
movement 4 clicks

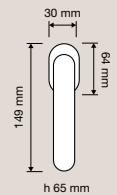

760 SK
Maniglia per finestra
con movimento
DK SmartBlock /
Window handle
with DK SmartBlock
movement

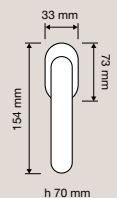

Garda



Finiture / Finishes



CR | Cromo lucido /
Polished chrome



CS | Cromo satinato /
Satin chrome



OG | Ottone bronzato
graffiato / *Bronzed
brass*



NS | Nickel satinato /
Satin nickel



OL | Ottone lucido
verniciato / *Polished
brass*



OS | Ottone satinato /
Satin brass

La semplicità è alla base di questa maniglia, contraddistinta dall'impugnatura particolarmente arrotondata che trasmette una piacevole sensazione alla mano.

Simplicity is at the base of this handle, characterised by the particularly rounded handgrip that transmits a pleasant sensation to the hand.

Collezione / Collection

670 RB 096
Maniglia con rosetta
art.096 / Door
handle on rose
art.096

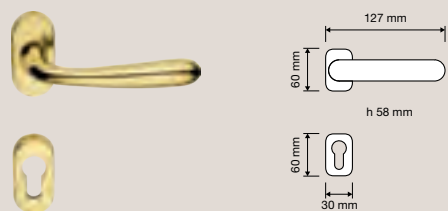

670 RB 101
Maniglia con rosetta
art.101 / Door handle
on rose art.101

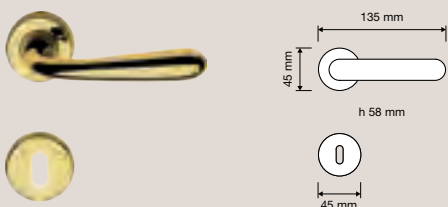

670 PL
Maniglia con placca /
Door handle on plate

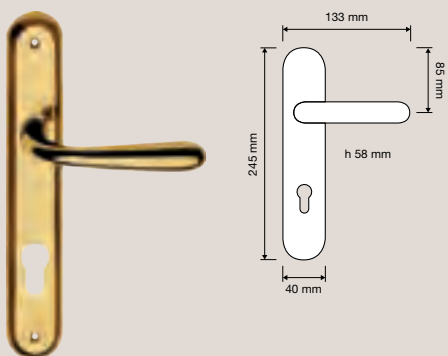

670 CR
Cremonese /
Window handle gratz



670 MX
Maniglia per finestra
export quadro 7mm
/ Window handle
export 7mm square



670 DK
Maniglia per finestra
con movimento DK 4
posizioni / Window
handle with DK
movement 4 clicks

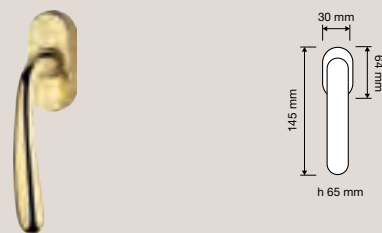

670 SK
Maniglia per finestra
con movimento
DK SmartBlock /
Window handle
with DK SmartBlock
movement

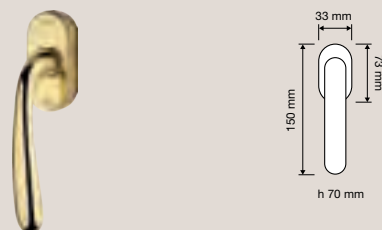

670 MN 200 101
Maniglione con
rosette art.101 / Pull
handle on roses
art.101

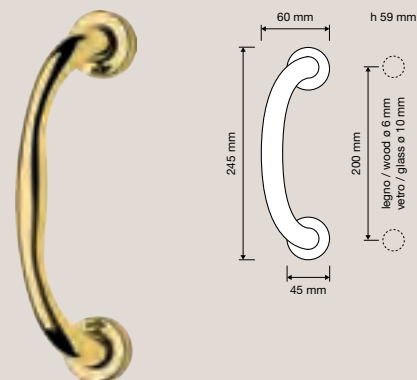

400 PT 065
Pomolo a tirare con
rosetta incorporata /
Fixed knob



Ibiza



Finiture / Finishes



AN | Ottone
invecchiato / *Aged
brass*



FV | Ferro effetto
invecchiato / *Aged
iron (brass)*



OG | Ottone bronzato
graffiato / *Bronzed
brass*



OL | Ottone lucido
verniciato / *Polished
brass*

Il mare che bacia la spiaggia di Portinatx è stato l'ispirazione del design dell'impugnatura, modellata come un'onda e che dona un tocco molto personale ad ogni ambiente.

The sea that kisses the beach of Portinatx provided the inspiration for the design of the handgrip, modelled like a wave and which gives all rooms a personal touch.

Collezione / Collection

545 RB 101
Maniglia con rosetta
art.101 / Door handle
on rose art.101

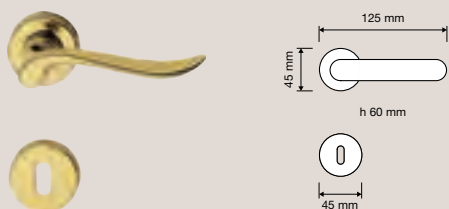

545 SK
Maniglia per finestra
con movimento
DK SmartBlock /
Window handle
with DK SmartBlock
movement

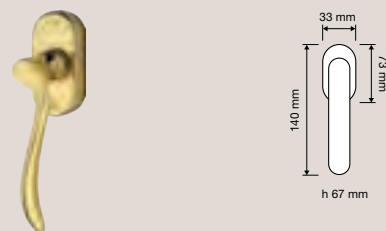

545 PL
Maniglia con placca /
Door handle on plate

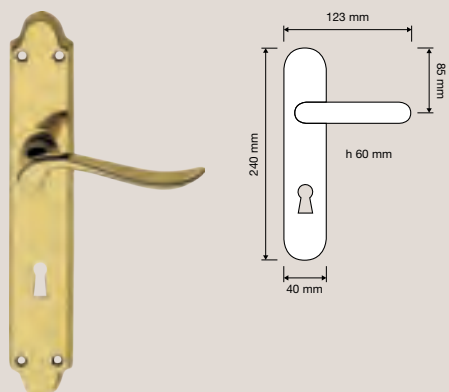

545 CR
Cremonese /
Window handle gratz

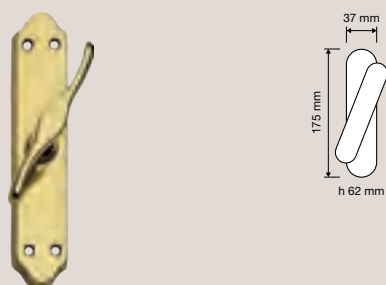

545 MX
Maniglia per finestra
export quadro 7mm
/ Window handle
export 7mm square

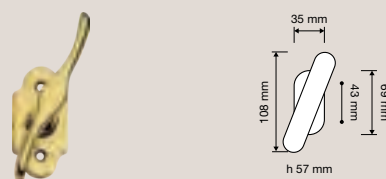

545 DK
Maniglia per finestra
con movimento DK 4
posizioni / Window
handle with DK
movement 4 clicks



Onda

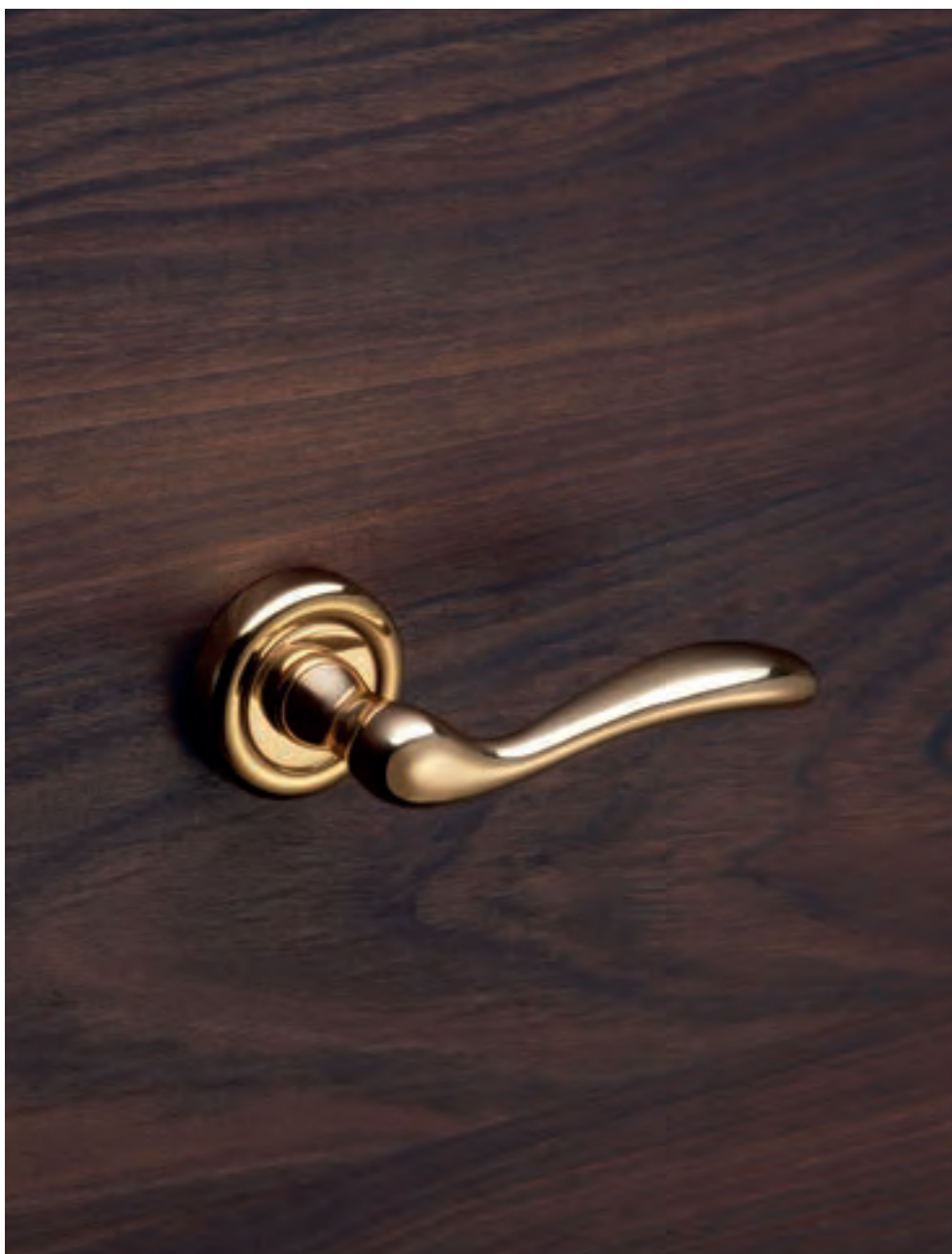

Finiture / Finishes



BM | Bronzo opaco /
Matt bronze



OG | Ottone bronzato
graffiato / Bronzed
brass



OL | Ottone lucido
verniciato / Polished
brass



OS | Ottone satinato /
Satin brass

Ispirata alle onde e bellezze del Lago di Garda, è contraddistinta dal particolare incavo dell'impugnatura che le dona una presa estremamente sicura e comoda.

Inspired by the waves and beauty of Lake Garda, it is distinguished by the particular recess of the handgrip that gives it an extremely firm and comfortable grasp.

Collezione / Collection

530 RB 101
Maniglia con rosetta
art.101 / Door handle
on rose art.101

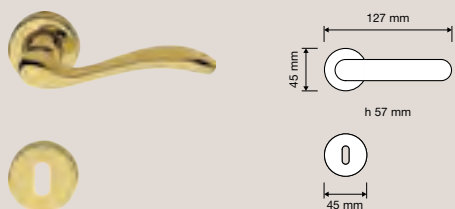

530 SK
Maniglia per finestra
con movimento
DK SmartBlock /
Window handle
with DK SmartBlock
movement



530 RB 103
Maniglia con rosetta
art.103 / Door handle
on rose art.103

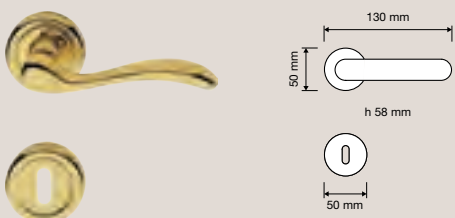

530 PL
Maniglia con placca /
Door handle on plate

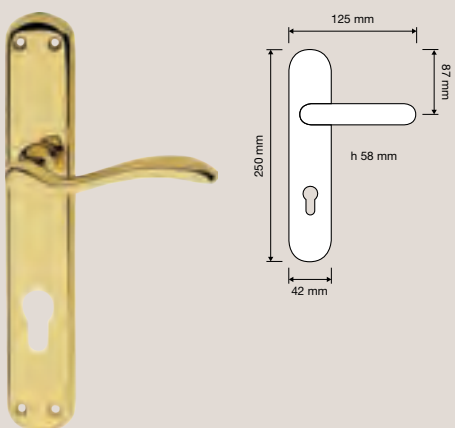

530 CR
Cremonese /
Window handle gratz

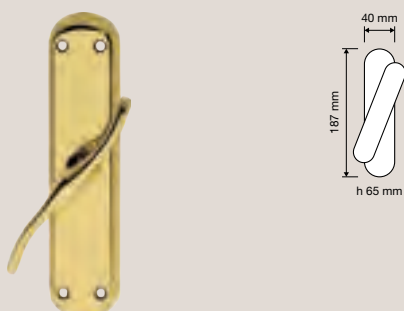

530 DK
Maniglia per finestra
con movimento DK 4
posizioni / Window
handle with DK
movement 4 clicks



Piuma —



Le cose semplici sono le più difficili da progettare, ma quando ci si riesce il risultato è notevole, così è stato per questa collezione, caratterizzata da linee armoniose.

The simplest things are the most difficult to design, but when you succeed the result is striking, so it was for this collection.

Collezione / Collection

Finiture / Finishes



CR | Cromo lucido /
Polished chrome



CS | Cromo satinato /
Satin chrome



OG | Ottone bronzato
graffiato / Bronzed
brass



OL | Ottone lucido
verniciato / Polished
brass

1415 RB 096
Maniglia con rosetta
art.096 / Door
handle on rose
art.096

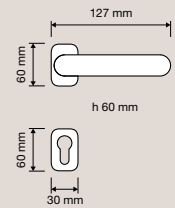

1415 RB 101
Maniglia con rosetta
art.101 / Door handle
on rose art.101

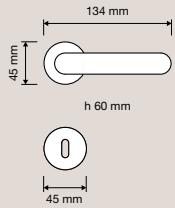

1415 PL
Maniglia con placca /
Door handle on plate

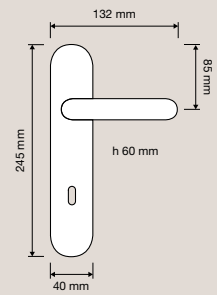

1415 DK
Maniglia per finestra
con movimento DK 4
posizioni / Window
handle with DK
movement 4 clicks

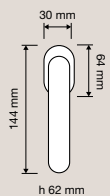

1415 SK
Maniglia per finestra
con movimento
DK SmartBlock /
Window handle
with DK SmartBlock
movement

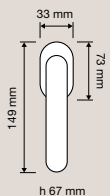



Crystal



Brilliant Crystal



Finiture / Finishes



OF | Oro francese /
French gold



OZ | Oro zecchino /
Gold plated



PM | Patiné / Patiné
mat

Cristalli / Crystals

Linea Cali utilizza
esclusivamente cristalli
Swarovski® originali.
/ Linea Cali uses only
original Swarovski®
crystals.



La musica dell'Opéra di Parigi riaffiora
alla mente evocata dalle linee sfarzose
di questa maniglia in stile Luigi XIV.

*The music of the Paris Opéra comes
to mind evoked by the lavish lines of
this handle in the Louis XIV style.*

Collezione / Collection

1526 RB 015
Maniglia con rosetta
art.015 / Door handle
on rose art.015

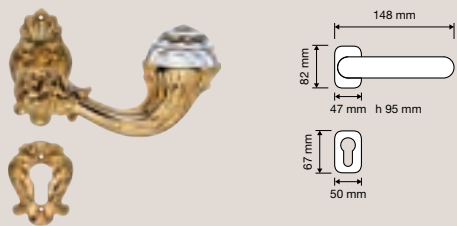

1526 RB 113
Maniglia con rosetta
art.113 / Door handle
on rose art.113

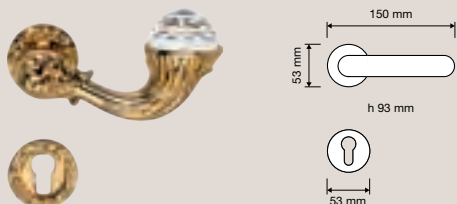

1531 PL
Maniglia con placca
art.1165 / Door
handle on plate
art.1165

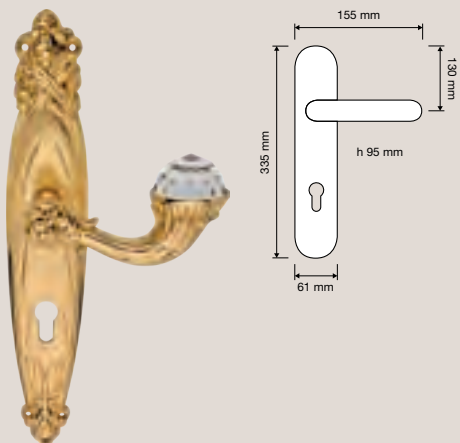

1526 PL
Maniglia con placca
art.1308 / Door
handle on plate
art.1308

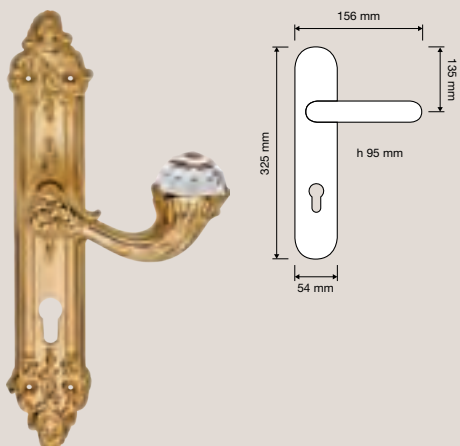

1530 PL
Maniglia con placca
art.1405 / Door
handle on plate
art.1405

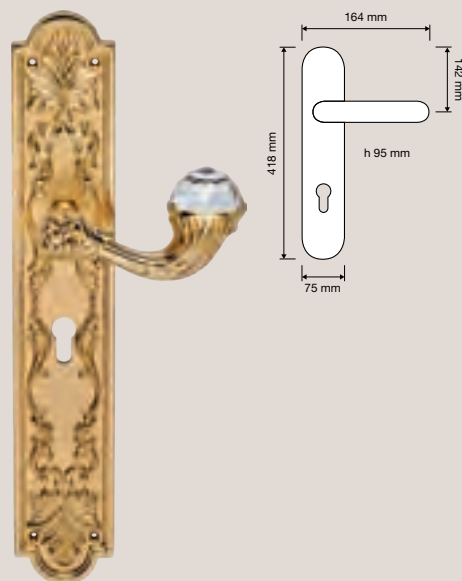

Brilliant Diamond



Finiture / Finishes



OF | Oro francese /
French gold



OZ | Oro zecchino /
Gold plated



PM | Patiné / Patiné
mat

Cristalli / Crystals

Linea Cali utilizza
esclusivamente cristalli
Swarovski® originali.
/ Linea Cali uses only
original Swarovski®
crystals.



Il mito della cornucopia torna a rivivere con questa rilettura contemporanea dei designer Linea Cali che rappresenta uno degli emblemi della ricchezza contemporanea.

The myth of the cornucopia comes back to life thanks to the stylistic reinterpretation of Linea Cali which represents one of the emblems of contemporary wealth.

Collezione / Collection

1525 RB 015
Maniglia con rosetta
art.015 / Door handle
on rose art.015

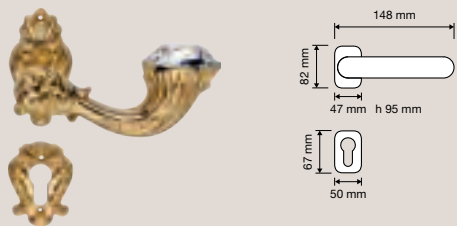

1525 RB 113
Maniglia con rosetta
art.113 / Door handle
on rose art.113

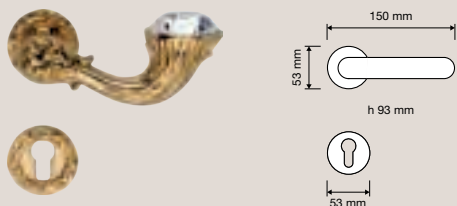

1528 PL
Maniglia con placca
art.1165 / Door
handle on plate
art.1165

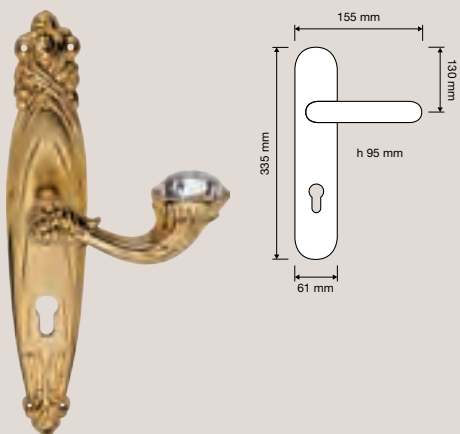

1527 PL
Maniglia con placca
art.1308 / Door
handle on plate
art.1308

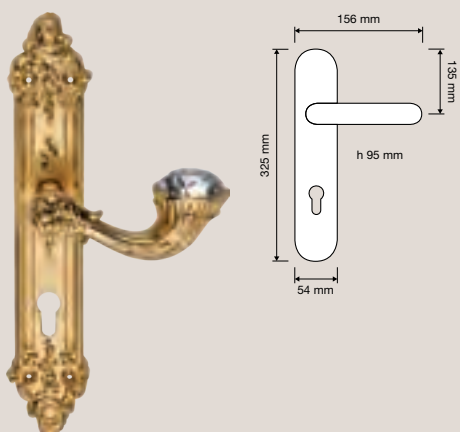

1529 PL
Maniglia con placca
art.1405 / Door
handle on plate
art.1405



Cosmic —



Il concetto di maniglia classica è riletto in chiave moderna e arricchito da dettagli contemporanei come il ricciolo dell'impugnatura di forma squisitamente circolare.

The conventional handle is given a modern twist and enhanced with contemporary details such as the curl of the hand grip with the delightfully rounded shape.

Finiture / Finishes



CR | Cromo lucido /
Polished chrome



CS | Cromo satinato /
Satin chrome



OZ | Oro zecchino /
Gold plated

Cristalli / Crystals

Linea Cali utilizza
esclusivamente cristalli
Swarovski® originali.
/ Linea Cali uses only
original Swarovski®
crystals.



Collezione / Collection

1335 RB 103
Maniglia con rosetta
art.103 / Door handle
on rose art.103

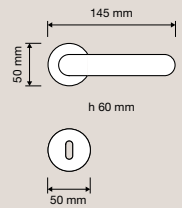

1335 PL
Maniglia con placca /
Door handle on plate

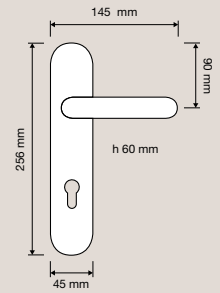

1335 DK
Maniglia per finestra
con movimento DK 4
posizioni / Window
handle with DK
movement 4 clicks

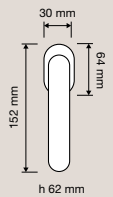

1335 SK
Maniglia per finestra
con movimento
DK SmartBlock /
Window handle
with DK SmartBlock
movement

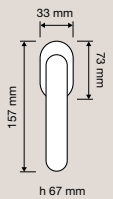

209 PB 0022
Pomolo per mobile /
Cabinet knob

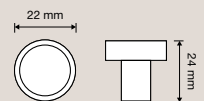

209 PB 0030
Pomolo per mobile /
Cabinet knob

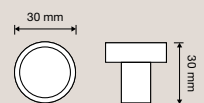

Crystal —



Finiture / Finishes



CR | Cromo lucido /
Polished chrome



OZ | Oro zecchino /
Gold plated

Cristalli / Crystals

Linea Cali utilizza
esclusivamente cristalli
Swarovski® originali.
*/ Linea Cali uses only
original Swarovski®
crystals.*



La bellezza dei cristalli Swarovski® è
oggetto di culto in questa collezione
dalle linee importanti ma allo stesso
tempo eleganti.

*The beauty of Swarovski® crystals is
an object of worship in this collection
that is made up of formal but at the
same time elegant lines.*

Collezione / Collection

830 RB 103
Maniglia con rosetta
art.103 / Door handle
on rose art.103

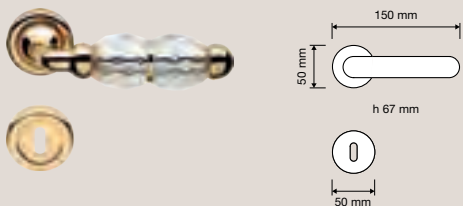

830 PG 103
Pomolo a girare
con rosetta art.103
/ Turnable knob on
rose art.103



830 CR
Cremonese /
Window handle gratz



830 DK
Maniglia per finestra
con movimento DK 4
posizioni / Window
handle with DK
movement 4 clicks

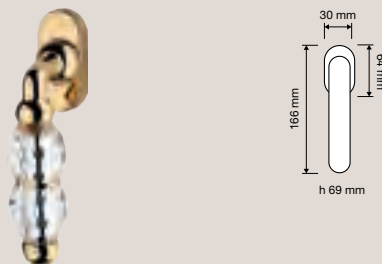

830 SK
Maniglia per finestra
con movimento
DK SmartBlock /
Window handle
with DK SmartBlock
movement

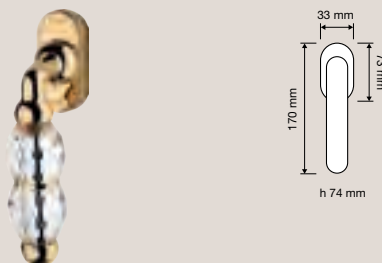

830 PT 065
Pomolo a tirare /
Fixed knob

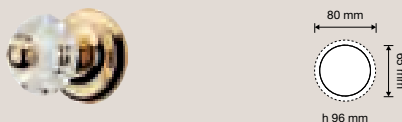

830 MN 236 103
Maniglione con
rosette art.103.
Interassi disponibili
236-310-420-
500. Attenzione:
l'interasse può
variare leggermente,
chiedere sempre
le misure prima di
forare la porta. /
Pull handle on roses
art.103. Available
distances 236-310-
420-500. Attention:
the distance can
have little changes,
please always ask
before making the
holes in the door.

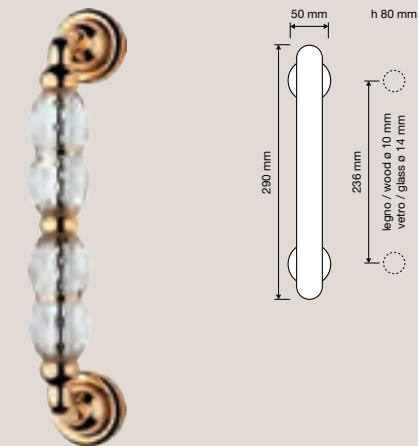

200 PB 0020
Pomolo per mobile /
Cabinet knob

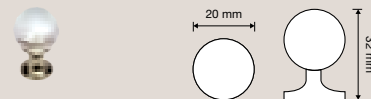

200 PB 0030
Pomolo per mobile /
Cabinet knob

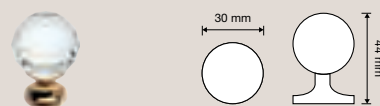

200 PB 0040
Pomolo per mobile /
Cabinet knob

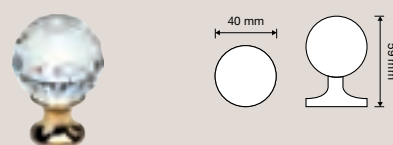

Elika Crystal



Finiture / Finishes



OZ | Oro zecchino /
Gold plated

Cristalli / Crystals

Linea Cali utilizza
esclusivamente cristalli
Swarovski® originali.
/ Linea Cali uses only
original Swarovski®
crystals.



Linee sfuggenti, ma importanti,
donano un'inaspettata dinamicità
alle importanti forme, rese ancor più
sorprendenti dalla luce emanata da un
cristallo Swarovski®.

*Elusive lines give an unexpected
dynamic to the formal shapes, made
even more surprising by the light
released by the Swarovski® crystal.*

Collezione / Collection

991 RB 108
Maniglia con rosetta
art.108 / Door handle
on rose art.108

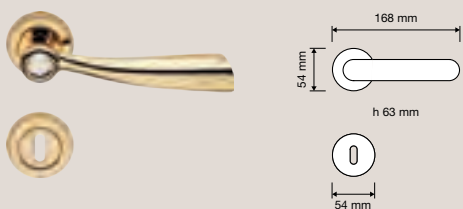

991 PT 060
Pomolo a tirare /
Fixed knob



991 PL
Maniglia con placca /
Door handle on plate

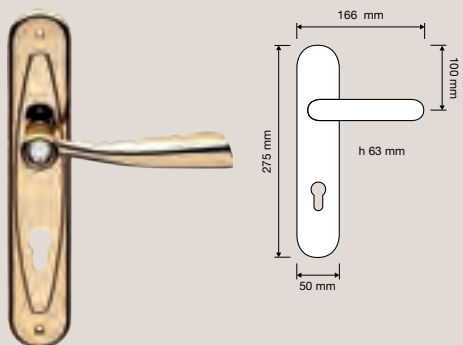

991 PG 108
Pomolo a girare
con rosetta art.108
/ Turnable knob on
rose art.108

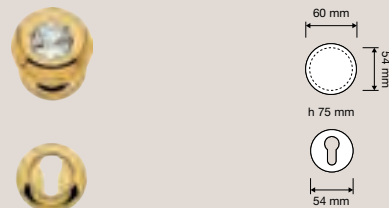

991 CR
Cremonese /
Window handle gratz

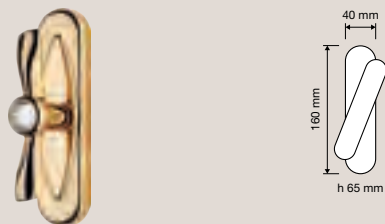

991 MN 275 108
Maniglia con
rosette art.108 /
Pull handle on roses
art.108

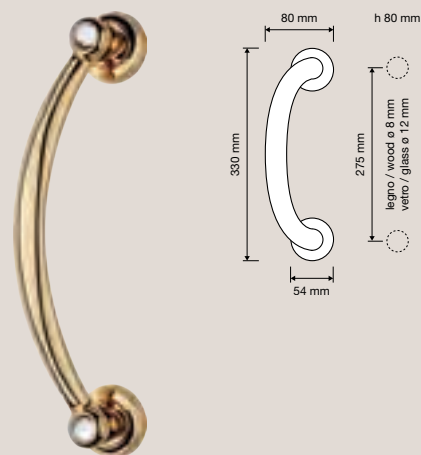

991 DK
Maniglia per finestra
con movimento DK 4
posizioni / Window
handle with DK
movement 4 clicks

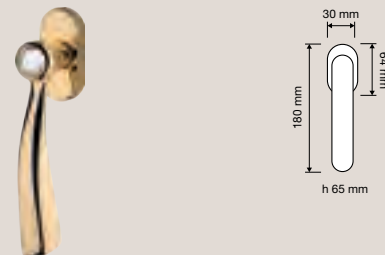

991 BA
Battente / Door
knocker

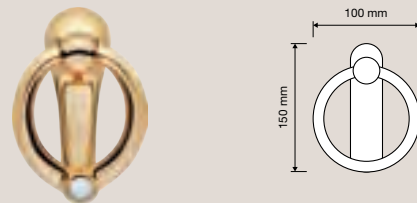

991 SK
Maniglia per finestra
con movimento
DK SmartBlock /
Window handle
with DK SmartBlock
movement

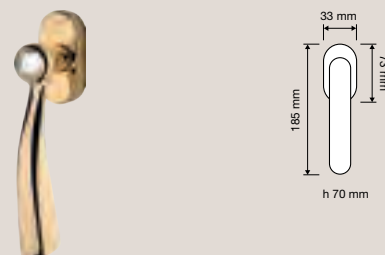

991 PB 0026
Pomolo per mobile /
Cabinet knob

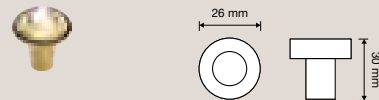

991 PB 0035
Pomolo per mobile /
Cabinet knob

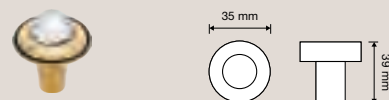

Elios Crystal —



Il concetto di modernità è riassunto in questa maniglia dalle forme decise ma aggraziate, impreziosite da un cristallo Swarovski® che sprigiona riflessi dai mille colori.

This handle is the emblem of modern design with decisive yet graceful shapes, embellished with a Swarovski® crystal that emanates multi coloured reflections.

Collezione / Collection

Finiture / Finishes



CR | Cromo lucido /
Polished chrome



CS | Cromo satinato /
Satin chrome



OZ | Oro zecchino /
Gold plated

Swarovski / Swarovski

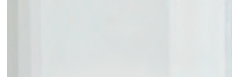

1340 | Trasparente /
Transparent



1343 | Jet nero / Black
Jet



1344 | Mesh trasparente
/ Mesh transparent

Linea Cali utilizza
esclusivamente cristalli
Swarovski® originali.
/ Linea Cali uses only
original Swarovski®
crystals.



1340 RB 019
Maniglia con rosetta
art.019 / Door handle
on rose art.019

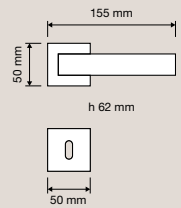

1340 RB 024
Maniglia con rosetta
art.024 / Door
handle on rose
art.024

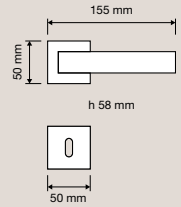

1340 PL
Maniglia con placca /
Door handle on plate

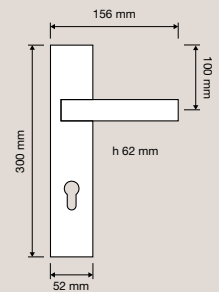

1340 DK
Maniglia per finestra
con movimento DK 4
posizioni / Window
handle with DK
movement 4 clicks

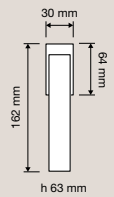

1340 SK
Maniglia per finestra
con movimento
DK SmartBlock /
Window handle
with DK SmartBlock
movement

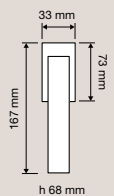

Collezione / Collection

323 PB 0000
Pomolo per mobile /
Cabinet knob

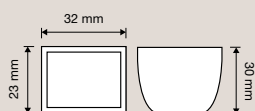



Contraddistinta da una curvatura molto accentuata, l'impugnatura è formata da un alto profilo di ottone che diventa un tutt'uno con il collo della maniglia.

Distinguished by a very pronounced curvature, the handle is formed by a high brass profile that becomes one with the neck.

Feeling —



L'irresistibile fascino dei brillanti è racchiuso in questa esclusiva collezione adornata da decine e decine di cristalli Swarovski®.

The irresistible charm of diamonds is contained in this exclusive collection adorned with dozens and dozens of Swarovski® crystals.

Finiture / Finishes



CR | Cromo lucido /
Polished chrome



OZ | Oro zecchino /
Gold plated

Cristalli / Crystals

Linea Cali utilizza
esclusivamente cristalli
Swarovski® originali.
/ Linea Cali uses only
original Swarovski®
crystals.



Collezione / Collection

1735 RB 103
Maniglia con rosetta
art.103 / Door handle
on rose art.103

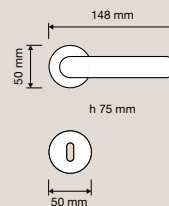

1735 PL
Maniglia con placca /
Door handle on plate

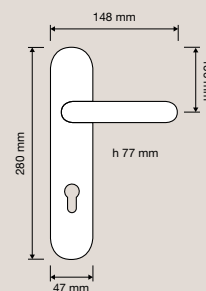
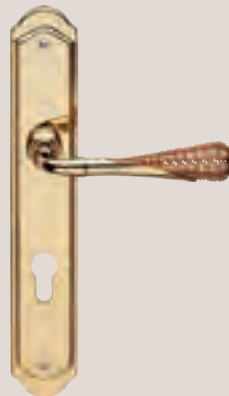

1735 DK
Maniglia per finestra
con movimento DK 4
posizioni / Window
handle with DK
movement 4 clicks

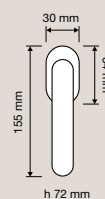

1735 SK
Maniglia per finestra
con movimento
DK SmartBlock /
Window handle
with DK SmartBlock
movement

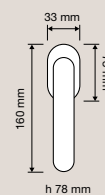

Fish Crystal

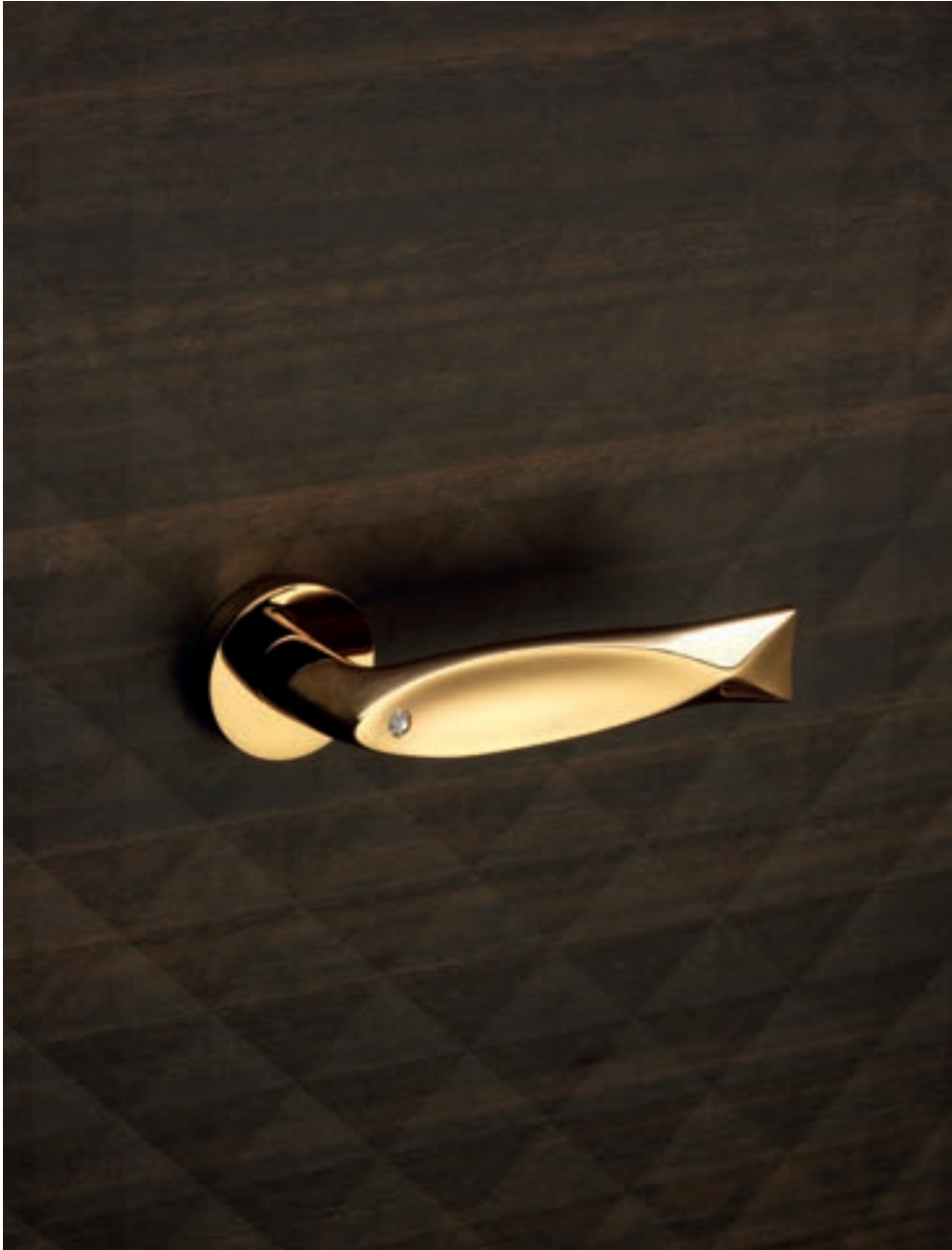

Finiture / Finishes



CR | Cromo lucido /
Polished chrome



CS | Cromo satinato /
Satin chrome



OZ | Oro zecchino /
Gold plated

Cristalli / Crystals

Linea Cali utilizza esclusivamente cristalli Swarovski® originali.
/ Linea Cali uses only original Swarovski® crystals.



Una forma semplice ma molto simbolica che evoca la calma, l'armonia e una sorta di mistero, peculiarità dell'ambiente marino.

A simple but very symbolic form that evokes tranquillity, harmony and a sort of mystery, a distinctive feature of marine environments.

Collezione / Collection

700 RB 023
Maniglia con rosetta
art.023 / Door
handle on rose
art.023

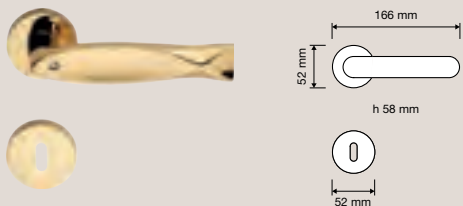

700 RB 025
Maniglia con rosetta
art.025 / Door
handle on rose
art.025

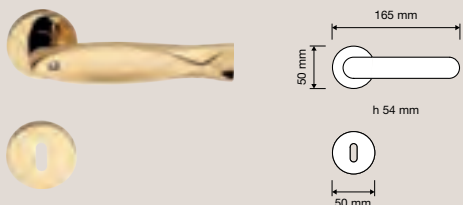

700 PL
Maniglia con placca
art.955 / Door
handle on plate
art.955

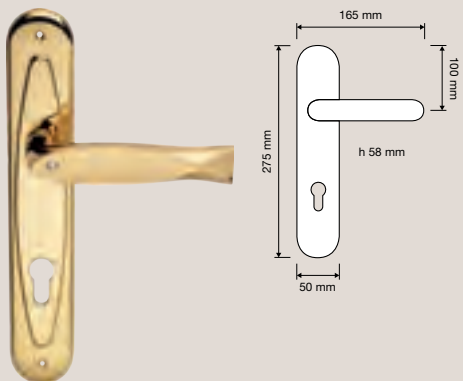

700 DK
Maniglia per finestra
con movimento DK 4
posizioni / Window
handle with DK
movement 4 clicks



700 SK
Maniglia per finestra
con movimento
DK SmartBlock /
Window handle
with DK SmartBlock
movement



Flory —



Come un bellissimo fiore ci ricorda che siamo amati, Flory ama mettersi in mostra illuminandosi con i suoi grandi cristalli Swarovski®.

As a beautiful flower reminds us that we are loved, Flory loves to show off by brightening up with her large Swarovski® crystals.

Finiture / Finishes



CR | Cromo lucido /
Polished chrome



OZ | Oro zecchino /
Gold plated

Swarovski / Swarovski

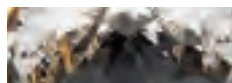

1745 | Trasparente /
Transparent



1746 | Giallo / Yellow



1747 | Viola / Violet

Cristalli / Crystals

Linea Cali utilizza
esclusivamente cristalli
Swarovski® originali.
/ Linea Cali uses only
original Swarovski®
crystals.



Collezione / Collection

1747 RB 023
Maniglia con rosetta
art.023 / Door
handle on rose
art.023

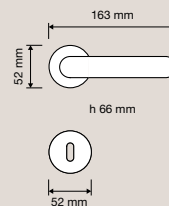

1747 RB 025
Maniglia con rosetta
art.025 / Door
handle on rose
art.025

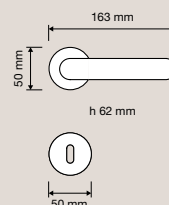

1747 PL
Maniglia con placca /
Door handle on plate

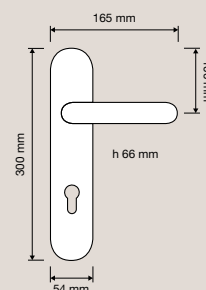

1747 DK
Maniglia per finestra
con movimento DK 4
posizioni / Window
handle with DK
movement 4 clicks

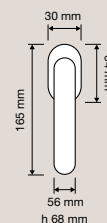

1747 SK
Maniglia per finestra
con movimento
DK SmartBlock /
Window handle
with DK SmartBlock
movement

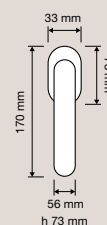

Collezione / Collection

1747 PT 056
Pomolo a tirare /
Fixed knob

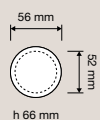

1747 PG 023
Pomolo a girare con
rosetta art.023 /
*Turnable knob on
rose art.023*

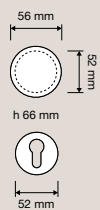



Havana Mesh —



Come un gioiello esalta la bellezza di una donna, un anello tempestato di cristalli Swarovski® illumina questa collezione sprigionando infiniti riflessi dai mille colori.

Just as a jewel brings out the beauty in a woman, a ring studded with Swarovski® crystals illuminates this collection bursting with infinite multi colour reflections.

Finiture / Finishes



CR | Cromo lucido /
Polished chrome



OZ | Oro zecchino /
Gold plated

Cristalli / Crystals

Linea Cali utilizza
esclusivamente cristalli
Swarovski® originali.
/ Linea Cali uses only
original Swarovski®
crystals.



Collezione / Collection

1090 RB 102
Maniglia con rosetta
art.102 / Door handle
on rose art.102

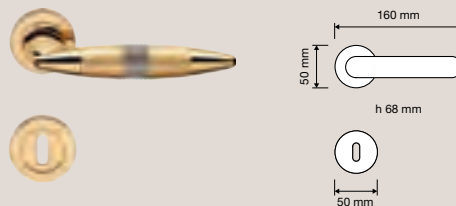

1090 PL
Maniglia con placca /
Door handle on plate

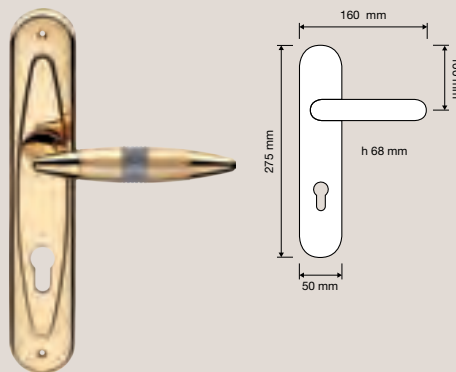

1090 DK
Maniglia per finestra
con movimento DK 4
posizioni / Window
handle with DK
movement 4 clicks



1090 SK
Maniglia per finestra
con movimento
DK SmartBlock /
Window handle
with DK SmartBlock
movement



1090 MN 267 102
Maniglione con
rosette art.102 /
Pull handle on roses
art.102

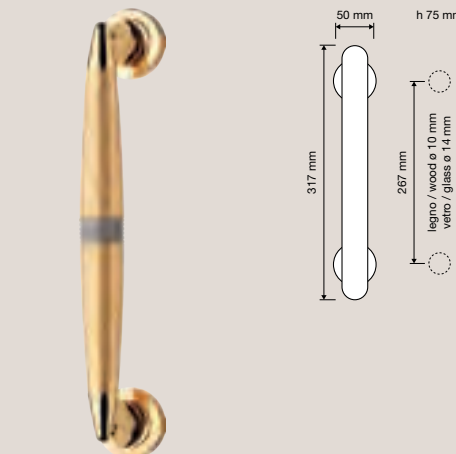

Idea Crystal —



Il cristallo Swarovski® incastonato nell'impugnatura pone l'accento sulle linee aggraziate e sinuose che rendono questa collezione "leggera" ma preziosa.

The Swarovski® crystal embedded in the handgrip emphasize the graceful and sinuous lines that make this collection "light" but precious.

Finiture / Finishes



OZ | Oro zecchino /
Gold plated

Cristalli / Crystals

Linea Cali utilizza
esclusivamente cristalli
Swarovski® originali.
/ Linea Cali uses only
original Swarovski®
crystals.



Collezione / Collection

871 RB 103
Maniglia con rosetta
art.103 / Door handle
on rose art.103

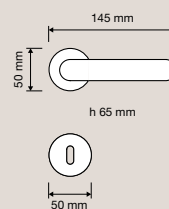

871 PL
Maniglia con placca /
Door handle on plate

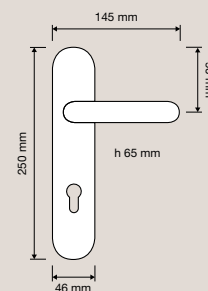

871 CR
Cremonese / Window
handle gratz



871 DK
Maniglia per finestra
con movimento DK 4
posizioni / Window
handle with DK
movement 4 clicks

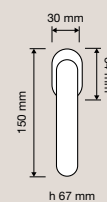

871 SK
Maniglia per finestra
con movimento
DK SmartBlock /
Window handle
with DK SmartBlock
movement

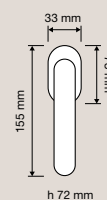

Jewel —



Finiture / Finishes



OZ | Oro zecchino /
Gold plated

Cristalli / Crystals

Linea Cali utilizza
esclusivamente cristalli
Swarovski® originali.
/ Linea Cali uses only
original Swarovski®
crystals.



Le mani sapienti di artigiani italiani hanno dato vita a questa collezione in stile Barocco che prevede l'incastonatura di decine e decine di cristalli Swarovski® utilizzando la stessa tecnica dei gioielli più preziosi.

The skilled hands of Italian artisans created this collection in the Baroque style that includes the settings of dozens and dozens of Swarovski® crystals using the same technique as the most precious jewels.

Collezione / Collection

1750 RB 015
Maniglia con rosetta
art.015 / Door handle
on rose art.015

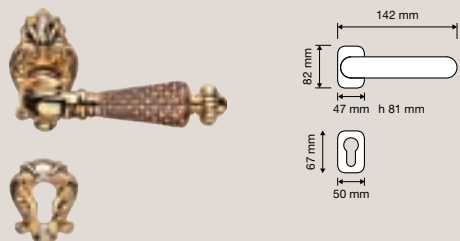

1750 DK
Maniglia per finestra
con movimento DK 4
posizioni / Window
handle with DK
movement 4 clicks

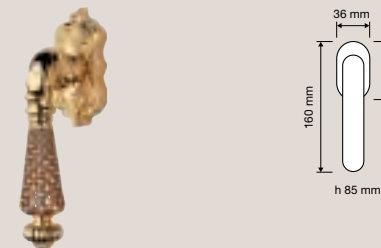

1750 RB 113
Maniglia con rosetta
art.113 / Door handle
on rose art.113

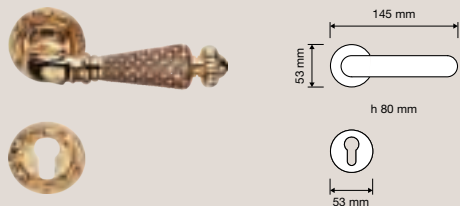

1751 FP
Pomolo fisso con
placca art.1397 /
Fixed knob on plate
art.1397

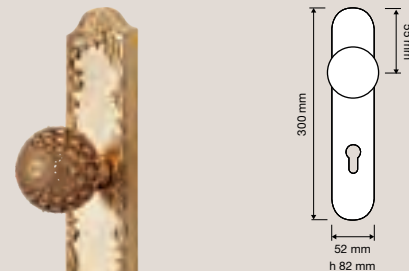

1750 PL
Maniglia con placca
art.1395 / Door
handle on plate
art.1395

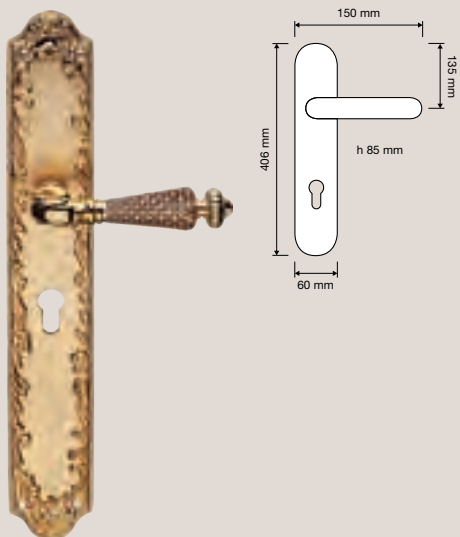

1750 MN 228
Maniglione / Pull
handle

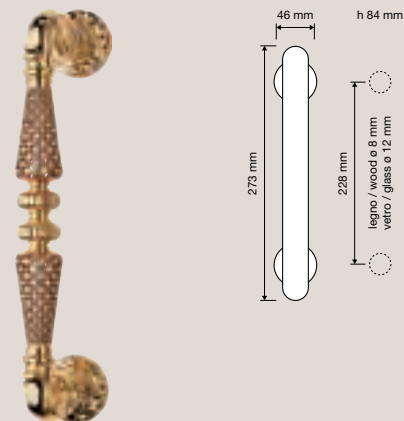

1751 PL
Maniglia con placca
art.1397 / Door
handle on plate
art.1397

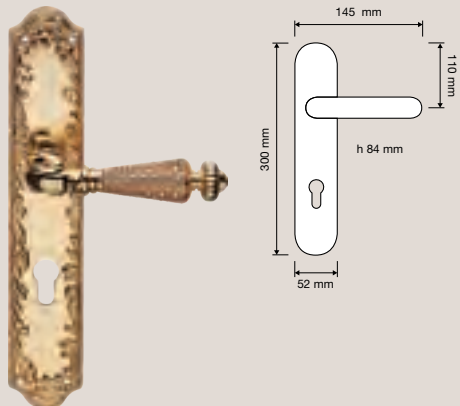

Collezione / Collection

1752 MN 728
Maniglione Big / Pull
handle Big

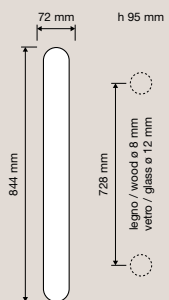



Particolare che mette in evidenza l'altissima precisione di montaggio e il grazioso finale dell'impugnatura di chiara ispirazione Vintage.

A detail that highlights the very high setting precision and the graceful finish of the handgrip of clear Vintage inspiration.

Led Mesh —



La perfezione di una rivièrè in cristalli Swarovski® impreziosisce la silhouette conica di questa raffinata collezione dal fascino discreto.

The perfection of a Swarovski® crystal rivièrè embellishes the conical silhouette of this refined collection with a discreet charm.

Finiture / Finishes



CR | Cromo lucido /
Polished chrome



CS | Cromo satinato /
Satin chrome



OZ | Oro zecchino /
Gold plated

Cristalli / Crystals

Linea Cali utilizza
esclusivamente cristalli
Swarovski® originali.
/ Linea Cali uses only
original Swarovski®
crystals.



Collezione / Collection

1680 RB 023
Maniglia con rosetta
art.023 / Door
handle on rose
art.023

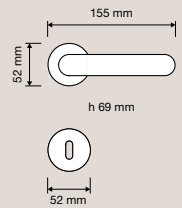

1680 RB 025
Maniglia con rosetta
art.025 / Door
handle on rose
art.025

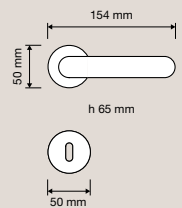

1680 PL
Maniglia con placca /
Door handle on plate

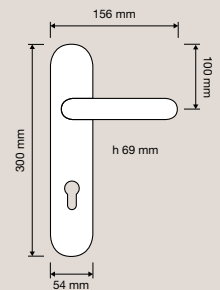

1680 DK
Maniglia per finestra
con movimento DK 4
posizioni / Window
handle with DK
movement 4 clicks

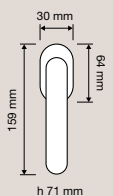

1680 SK
Maniglia per finestra
con movimento
DK SmartBlock /
Window handle
with DK SmartBlock
movement

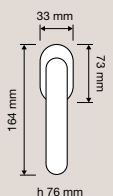

Luce —



Le atmosfere del Teatro La Fenice di Venezia e la voce di Maria Callas riaffiorano in questa raffinata collezione, contraddistinta dall'impugnatura in cristallo Swarovski®.

The atmosphere of Teatro La Fenice, the Phoenix Opera House in Venice, and the voice of Maria Callas re-emerges in this refined collection, characterised by the hand grip in Swarovski® crystal.

Finiture / Finishes



CR | Cromo lucido /
Polished chrome



CS | Cromo satinato /
Satin chrome



OZ | Oro zecchino /
Gold plated

Swarovski / Swarovski



1445 | Trasparente
con anello in ottone /
Transparent with brass
ring



1446 | Trasparente
con anello in ottone
e cristalli Mesh /
Transparent with brass
ring and Mesh crystals

Cristalli / Crystals

Linea Cali utilizza
esclusivamente cristalli
Swarovski® originali.
/ Linea Cali uses only
original Swarovski®
crystals.



Collezione / Collection

1445 RB 023
Maniglia con rosetta
art.023 / Door
handle on rose
art.023

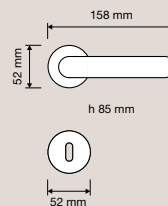

1445 RB 025
Maniglia con rosetta
art.025 / Door
handle on rose
art.025

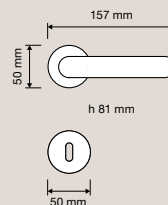

1445 PL
Maniglia con placca /
Door handle on plate

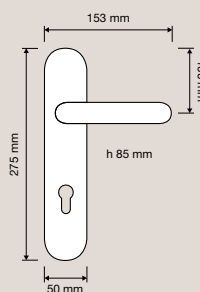

1445 DK
Maniglia per finestra
con movimento DK 4
posizioni / Window
handle with DK
movement 4 clicks

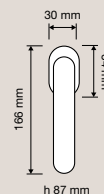

1445 SK
Maniglia per finestra
con movimento
DK SmartBlock /
Window handle
with DK SmartBlock
movement

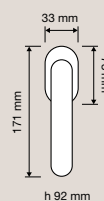

Collezione / Collection

1445 MN 254 023

Maniglione con
rosette art.023.

Attenzione:

l'interasse può
variare leggermente,
chiedere sempre
le misure prima di
forare la porta. /

*Pull handle on roses
art.023. Attention:
the distance can
have little changes,
please always ask
before making the
holes in the door.*

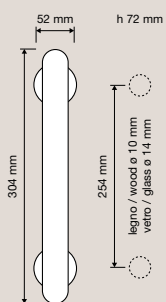



Unica e inimitabile, Luce si contraddistingue per la particolarissima forma dell'impugnatura in cristallo Swarovski® che le dona una raffinatezza senza eguali

Unique and inimitable, Luce stands out for the particularly unusual shape of the hand grip in Swarovski® crystal, which gives it an unequalled elegance.

Nau Crystal —



Un'insolita forma a spirale ospita una "perla" in cristallo Swarovski® che sprigiona riflessi dai mille colori.

An unusual spiral form holds a "pearl" in Swarovski® crystal that releases multi-coloured reflections.

Finiture / Finishes



CR | Cromo lucido /
Polished chrome



CS | Cromo satinato /
Satin chrome



OZ | Oro zecchino /
Gold plated

Cristalli / Crystals

Linea Cali utilizza
esclusivamente cristalli
Swarovski® originali.
/ Linea Cali uses only
original Swarovski®
crystals.



Collezione / Collection

1549 RB 023
Maniglia con rosetta
art.023 / Door
handle on rose
art.023

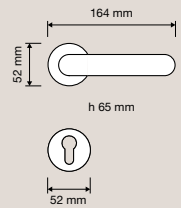

1549 RB 025
Maniglia con rosetta
art.025 / Door
handle on rose
art.025

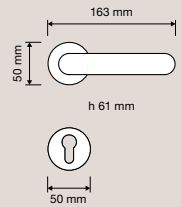

1551 PL
Maniglia con placca
art.1595 / Door
handle on plate
art.1595

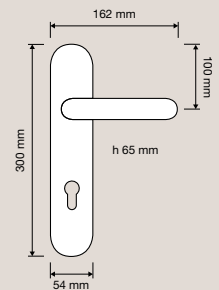

1549 DK
Maniglia per finestra
con movimento DK 4
posizioni / Window
handle with DK
movement 4 clicks

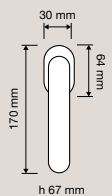

1549 SK
Maniglia per finestra
con movimento
DK SmartBlock /
Window handle
with DK SmartBlock
movement

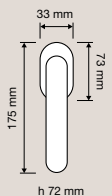

Ninfa Crystal



Finiture / Finishes



OF | Oro francese /
French gold



OZ | Oro zecchino /
Gold plated



PM | Patiné / Patiné
mat

Cristalli / Crystals

Linea Cali utilizza
esclusivamente cristalli
Swarovski® originali.
/ Linea Cali uses only
original Swarovski®
crystals.



Un omaggio alla nobiltà di un tempo,
una collezione che si distingue
per il suo design particolarmente
"aristocratico".

*A tribute to the nobility of the past, a
collection that is distinguished by its
particularly "aristocratic".*

Collezione / Collection

1542 RB 015
Maniglia con rosetta
art.015 / Door handle
on rose art.015

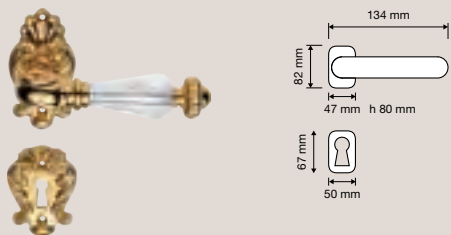

1542 DK
Maniglia per finestra
con movimento DK 4
posizioni / Window
handle with DK
movement 4 clicks



1542 RB 113
Maniglia con rosetta
art.113 / Door handle
on rose art.113

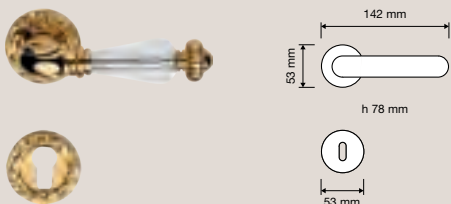

1545 PT
Pomolo a tirare /
Fixed knob



1542 PL
Maniglia con placca
art.1395 / Door
handle on plate
art.1395

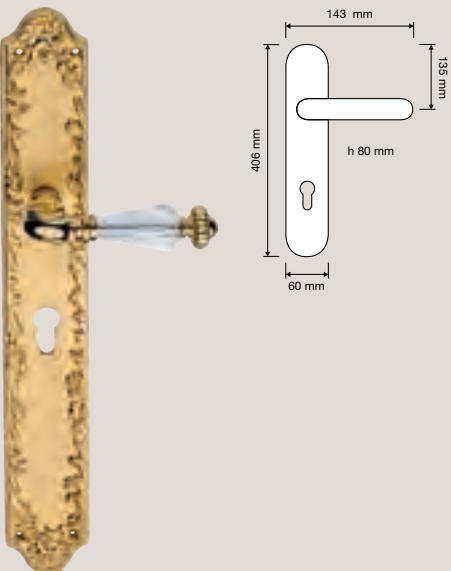

1545 PG
Pomolo a girare con
rosone art.1540 /
Turnable knob on big
rose art.1540

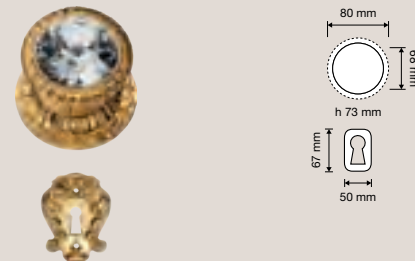

1543 PL
Maniglia con placca
art.1397 / Door
handle on plate
art.1397

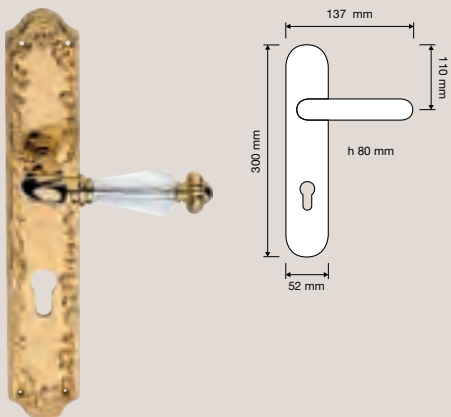

1542 MN 214
Maniglione.
Attenzione:
l'interasse può
variare leggermente,
chiedere sempre
le misure prima di
forare la porta. / Pull
handle. Attention:
the distance can have
little changes, please
always ask before
making the holes in
the door.

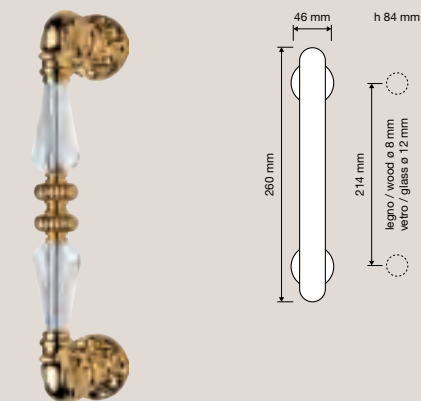

Opera Crystal



Finiture / Finishes



OZ | Oro zecchino /
Gold plated

Cristalli / Crystals

Linea Cali utilizza
esclusivamente cristalli
Swarovski® originali.
/ Linea Cali uses only
original Swarovski®
crystals.



L'irresistibile fascino dei cristalli Swarovski® accende questa imponente collezione, caratterizzata da uno stile rigoroso e aristocratico.

The irresistible fascination of Swarovski® crystals lights up this majestic collection, characterised by a meticulous and aristocratic style.

Collezione / Collection

1056 RB 112
Maniglia con rosetta
art.112 / Door handle
on rose art.112

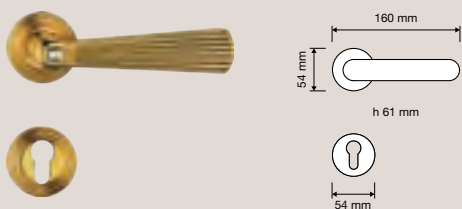

1056 PL
Maniglia con placca /
Door handle on plate

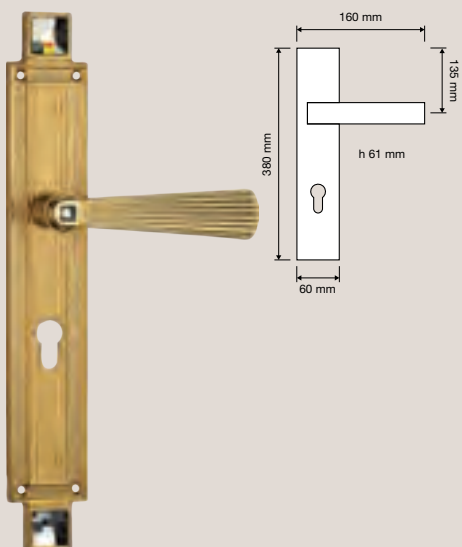

1056 DK
Maniglia per finestra
con movimento DK 4
posizioni / Window
handle with DK
movement 4 clicks

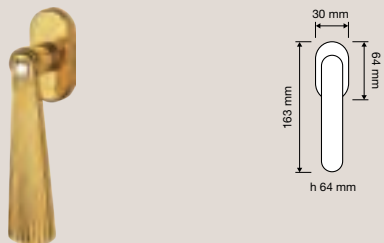

1056 SK
Maniglia per finestra
con movimento
DK SmartBlock /
Window handle
with DK SmartBlock
movement



1056 PT 070
Pomolo a tirare /
Fixed knob



1056 FP
Pomolo fisso con
placca / Fixed knob
on plate

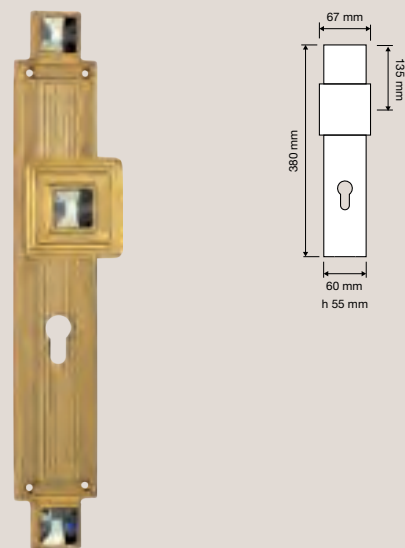

1056 MN 240
Maniglione / Pull
handle

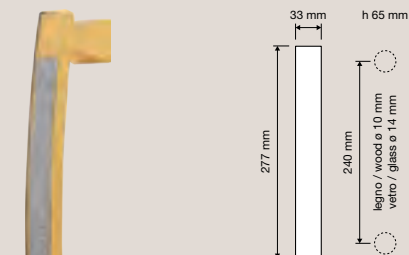

1056 AP
Maniglione
accoppiato su placca
/ Set pull handles on
plate

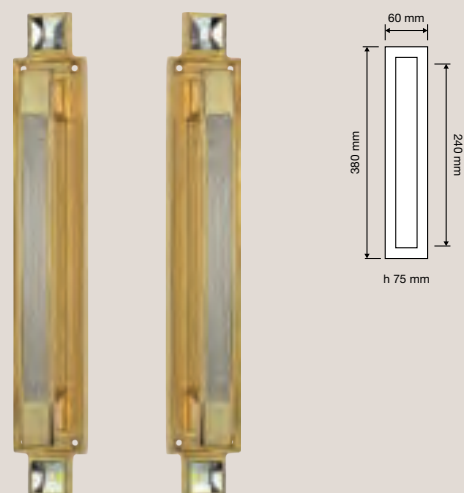

Point Crystal —



L'iconografia moderna è il leitmotiv di questa maniglia, priva di qualsiasi angolo vivo, illuminata da un importante cristallo Swarovski®.

Modern iconography is the leitmotiv of this handle, free of sharp edges, illuminated by an important Swarovski® crystal.

Collezione / Collection

Finiture / Finishes



CR | Cromo lucido /
Polished chrome



CS | Cromo satinato /
Satin chrome



OZ | Oro zecchino /
Gold plated

Cristalli / Crystals

Linea Cali utilizza
esclusivamente cristalli
Swarovski® originali.
/ Linea Cali uses only
original Swarovski®
crystals.



1596 RB 023
Maniglia con rosetta
art.023 / Door
handle on rose
art.023

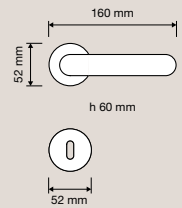

1596 RB 025
Maniglia con rosetta
art.025 / Door
handle on rose
art.025

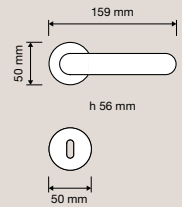

1596 PL
Maniglia con placca /
Door handle on plate

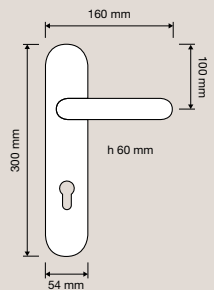

1596 DK
Maniglia per finestra
con movimento DK 4
posizioni / Window
handle with DK
movement 4 clicks

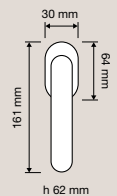

1596 SK
Maniglia per finestra
con movimento
DK SmartBlock /
Window handle
with DK SmartBlock
movement

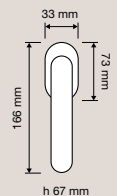

Profilo Mesh

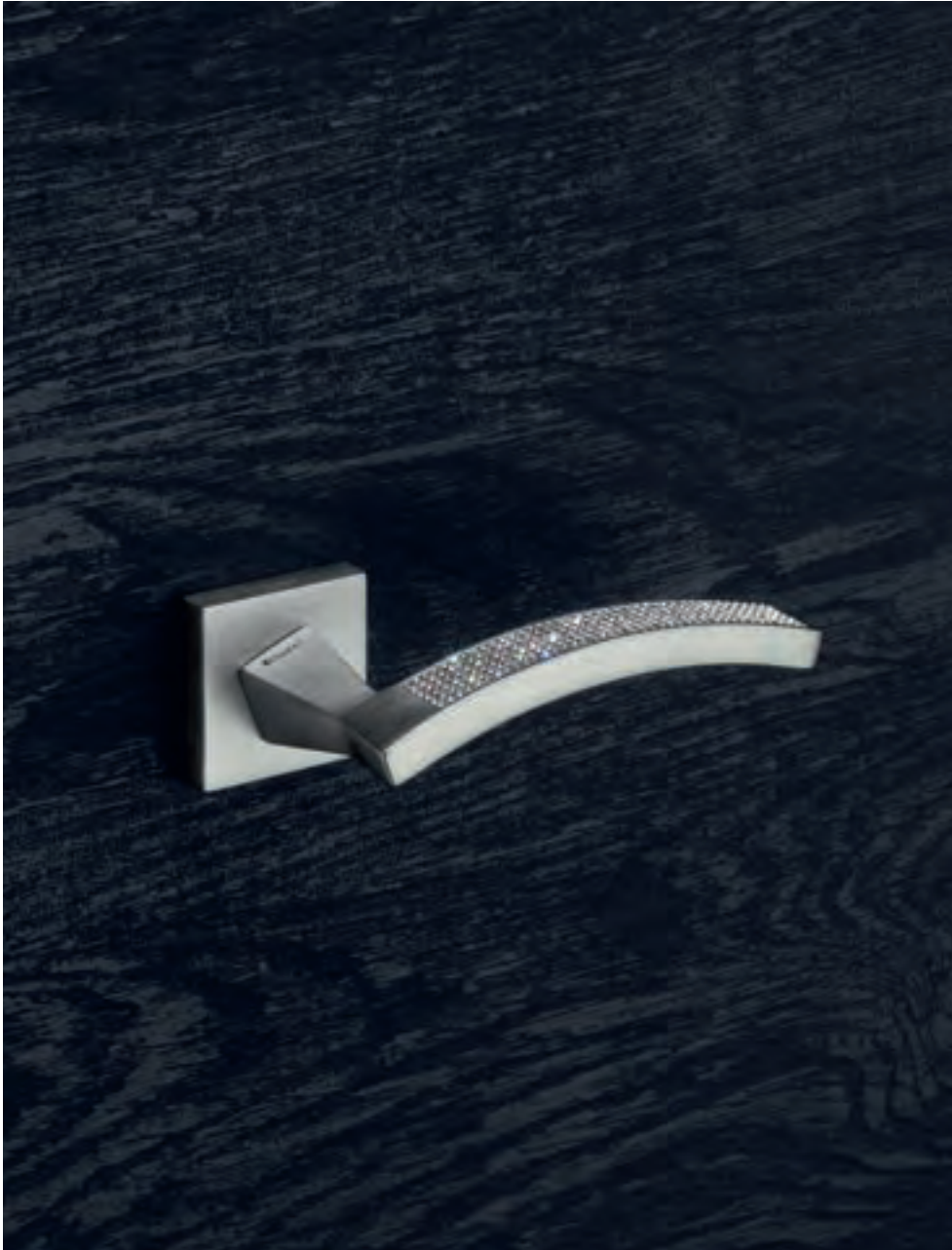

Finiture / Finishes



CR | Cromo lucido /
Polished chrome



CS | Cromo satinato /
Satin chrome



OZ | Oro zecchino /
Gold plated

Cristalli / Crystals

Linea Cali utilizza esclusivamente cristalli Swarovski® originali.
/ Linea Cali uses only original Swarovski® crystals.



La mano coglie la luce sfiorando un pavé di cristalli Swarovski® che rimanda all'arte orafa più preziosa.

The hand that lightly touches the Swarovski® crystals pavé captures the light and reminds us of the intricate work of the goldsmith.

Collezione / Collection

1041 RB 019
Maniglia con rosetta
art.019 / Door handle
on rose art.019

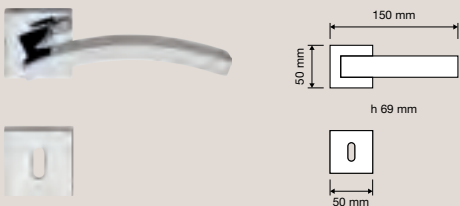

1041 RB 024
Maniglia con rosetta
art.024 / Door
handle on rose
art.024

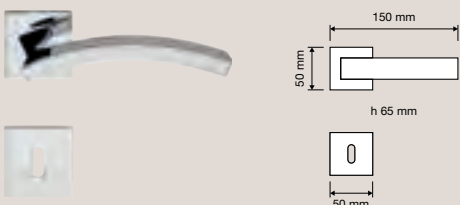

1041 RB 102
Maniglia con rosetta
art.102 / Door handle
on rose art.102

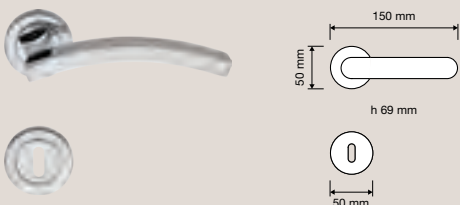

1041 PL
Maniglia con placca
art.1040 / Door
handle on plate
art.1040

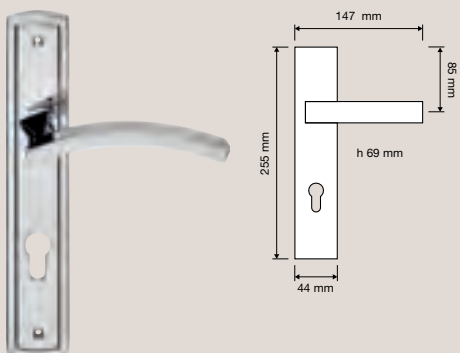

1041 CR
Cremonese /
Window handle gratz



1041 DK
Maniglia per finestra
con movimento DK 4
posizioni / Window
handle with DK
movement 4 clicks



1041 SK
Maniglia per finestra
con movimento
DK SmartBlock /
Window handle
with DK SmartBlock
movement



1041 MN 240
Maniglione / Pull
handle

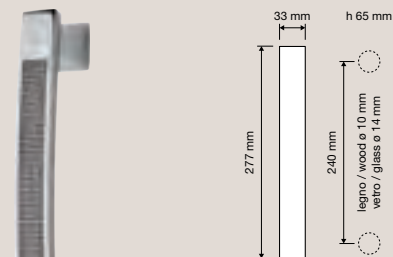

1043 PI
Placca incasso /
Flush pull

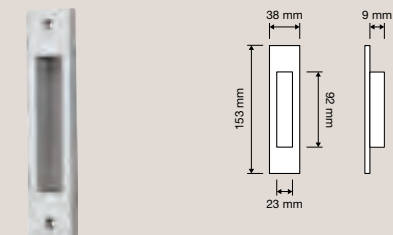

Reflex



Finiture / Finishes



CR | Cromo lucido /
Polished chrome



CS | Cromo satinato /
Satin chrome



OZ | Oro zecchino /
Gold plated

Cristalli / Crystals

Linea Cali utilizza esclusivamente cristalli Swarovski® originali.
/ Linea Cali uses only original Swarovski® crystals.



Il particolare taglio dei cristalli Swarovski®, studiato per esaltarne i riflessi, rende questa collezione una delle più copiate al mondo.

The particular cut of the Swarovski® crystals, designed to enhance the reflections, make this collection one of the most copied in the world.

Collezione / Collection

1215 RB 019
Maniglia con rosetta
art.019 / Door handle
on rose art.019

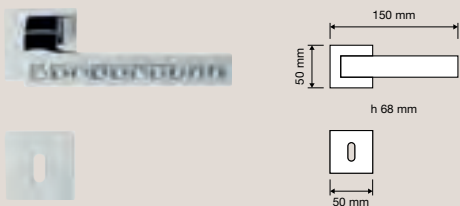

1215 PT 060
Pomolo a tirare /
Fixed knob



1215 RB 024
Maniglia con rosetta
art.024 / Door
handle on rose
art.024

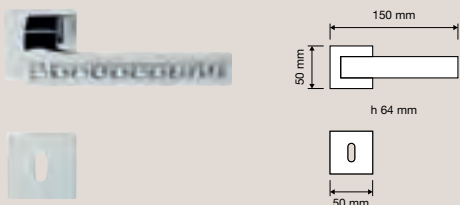

1215 PG 019
Pomolo a girare
con rosetta art.019
/ Turnable knob on
rose art.019



1216 PL
Maniglia con placca
art.1104 / Door
handle on plate
art.1104

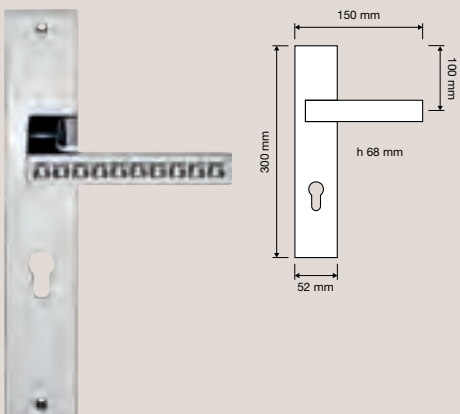

1215 MN 282
Maniglione / Pull
handle

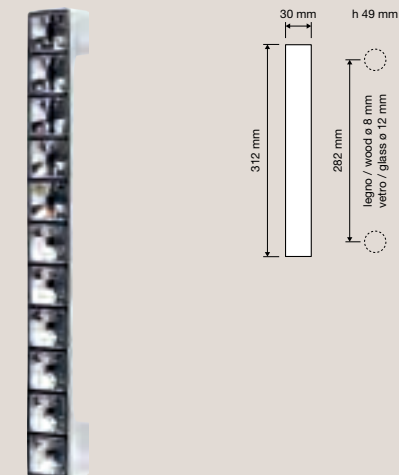

1215 DK
Maniglia per finestra
con movimento DK 4
posizioni / Window
handle with DK
movement 4 clicks

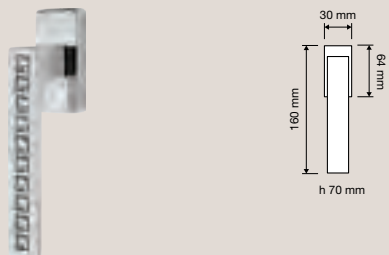

1215 AB
Appendiabiti / Coat
hook

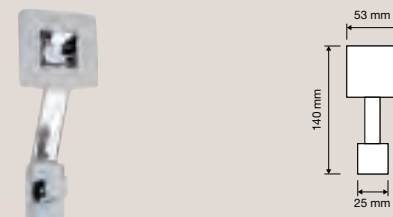

1215 SK
Maniglia per finestra
con movimento
DK SmartBlock /
Window handle
with DK SmartBlock
movement

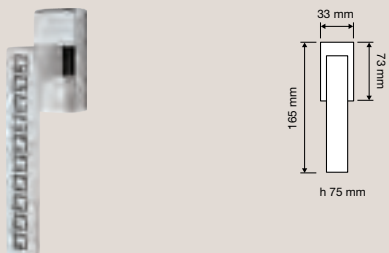

321 PB 0024
Pomolo per mobile /
Cabinet knob



Riflesso Mesh —



L'impugnatura ruotata verso la mano, oltre che essere comoda, pone in risalto un pavé composto da ben 264 cristalli SWAROVSKI®.

The handgrip turned toward the hand, as well as being comfortable, highlights a pavé composed of 264 SWAROVSKI® crystals.

Collezione / Collection

Finiture / Finishes



CR | Cromo lucido /
Polished chrome



CS | Cromo satinato /
Satin chrome



OZ | Oro zecchino /
Gold plated

Cristalli / Crystals

Linea Cali utilizza
esclusivamente cristalli
Swarovski® originali.
/ Linea Cali uses only
original Swarovski®
crystals.



1354 RB 019
Maniglia con rosetta
art.019 / Door handle
on rose art.019

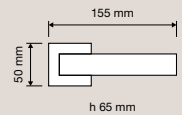

1354 RB 024
Maniglia con rosetta
art.024 / Door
handle on rose
art.024

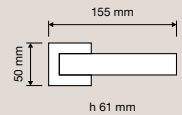

1354 PL
Maniglia con placca /
Door handle on plate

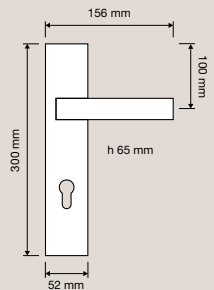

1354 DK
Maniglia per finestra
con movimento DK 4
posizioni / Window
handle with DK
movement 4 clicks

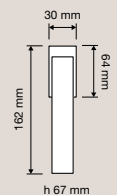

1354 SK
Maniglia per finestra
con movimento
DK SmartBlock /
Window handle
with DK SmartBlock
movement

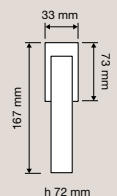

Riflesso Rocks _



Un oggetto di uso comune si trasforma in gioiello dalle mille sfaccettature e dagli infiniti riflessi di luce grazie a particolarissimi pavé di cristalli Swarovski®.

An everyday object is transformed into a jewel with infinite reflections and refractions thanks to the very particular pavé Swarovski® crystals.

Finiture / Finishes



CR | Cromo lucido / Polished chrome



CS | Cromo satinato / Satin chrome



OZ | Oro zecchino / Gold plated



VE | Nero opaco / Matt black

Swarovski / Swarovski



1351 | Rocks blu / Rocks blue



1358 | Rocks Jet nero / Rocks black Jet



1359 | Rocks grigio / Rocks grey

Cristalli / Crystals

Linea Cali utilizza esclusivamente cristalli Swarovski® originali. / Linea Cali uses only original Swarovski® crystals.



Collezione / Collection

1358 RB 019
Maniglia con rosetta
art.019 / Door handle
on rose art.019

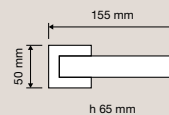

1358 RB 024
Maniglia con rosetta
art.024 / Door
handle on rose
art.024

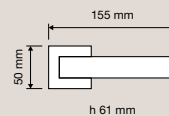

1358 PL
Maniglia con placca /
Door handle on plate

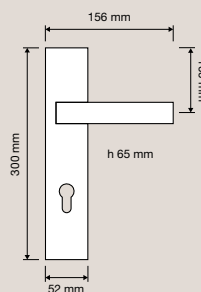

1358 DK
Maniglia per finestra
con movimento DK 4
posizioni / Window
handle with DK
movement 4 clicks

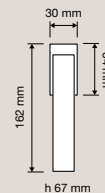

1358 SK
Maniglia per finestra
con movimento
DK SmartBlock /
Window handle
with DK SmartBlock
movement

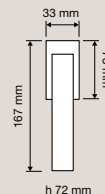

Shell Mesh

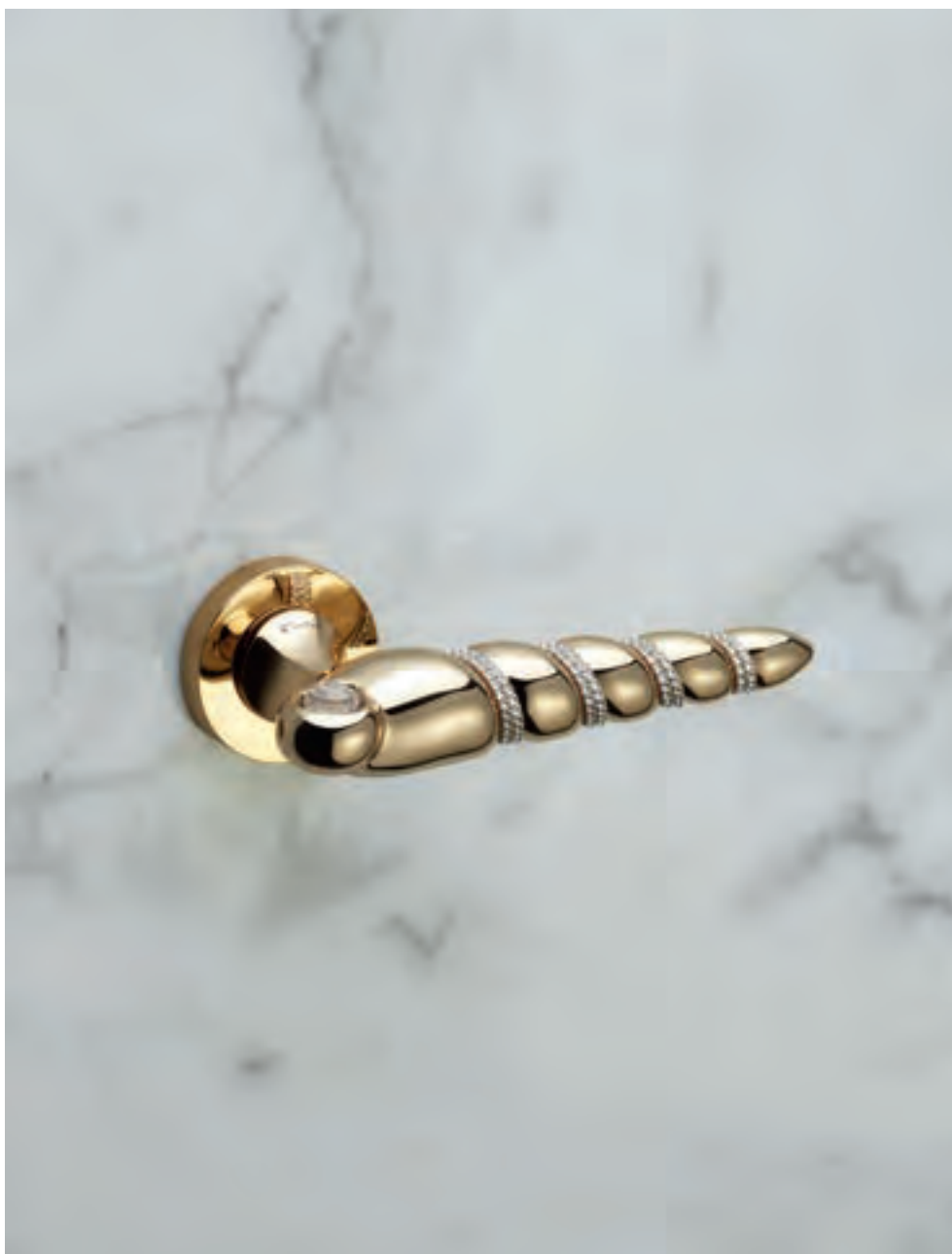

Finiture / Finishes



CR | Cromo lucido /
Polished chrome



CS | Cromo satinato /
Satin chrome



OZ | Oro zecchino /
Gold plated

Cristalli / Crystals

Linea Cali utilizza esclusivamente cristalli Swarovski® originali.
/ Linea Cali uses only original Swarovski® crystals.



Come un gioiello proveniente da un vecchio tesoro ritrovato su di un'isola deserta, impreziosito da un torchon di cristalli originali Swarovski®.

Like a jewel from an old treasure chest found on a desert island, embellished with a torchon of original Swarovski® crystals.

Collezione / Collection

694 RB 023
Maniglia con rosetta
art.023 / Door
handle on rose
art.023

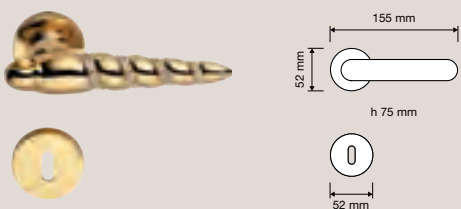

694 RB 025
Maniglia con rosetta
art.025 / Door
handle on rose
art.025

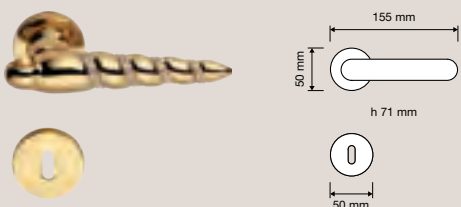

694 PL
Maniglia con placca /
Door handle on plate

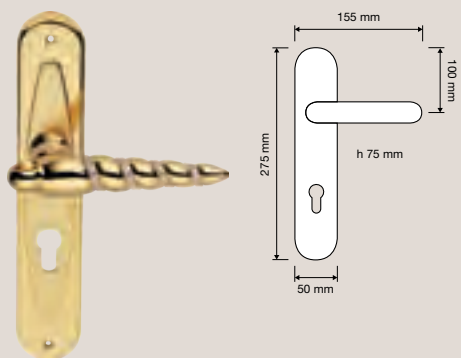

694 DK
Maniglia per finestra
con movimento DK 4
posizioni / Window
handle with DK
movement 4 clicks

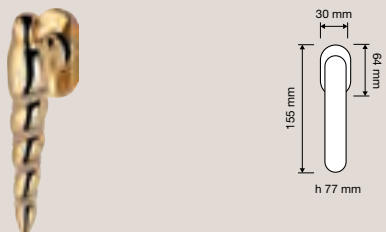

694 SK
Maniglia per finestra
con movimento
DK SmartBlock /
Window handle
with DK SmartBlock
movement

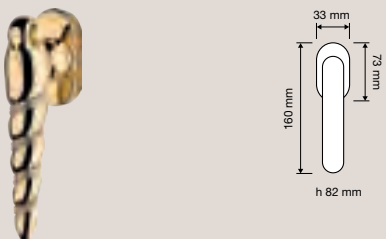

694 PT 070
Pomolo a tirare /
Fixed knob



694 PG 023
Pomolo a girare con
rosetta art.023 /
Turnable knob on
rose art.023



694 MN 248
Maniglione / Pull
handle

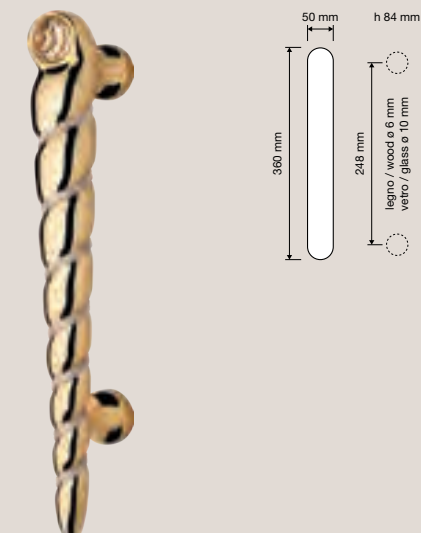

Sintesi Mesh —



Un grande pavé di cristalli Swarovski® sottolinea le linee decise e rigorose, nate per ambienti moderni.

The large Swarovski® crystals pavè highlight the decisive and exact lines, created to stand out in designer surroundings.

Collezione / Collection

Finiture / Finishes



CR | Cromo lucido /
Polished chrome



CS | Cromo satinato /
Satin chrome



OZ | Oro zecchino /
Gold plated

Cristalli / Crystals

Linea Cali utilizza
esclusivamente cristalli
Swarovski® originali.
/ Linea Cali uses only
original Swarovski®
crystals.



1301 RB 019
Maniglia con rosetta
art.019 / Door handle
on rose art.019

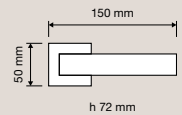

1301 RB 024
Maniglia con rosetta
art.024 / Door
handle on rose
art.024

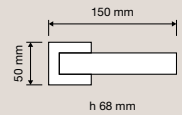

1301 PL
Maniglia con placca /
Door handle on plate

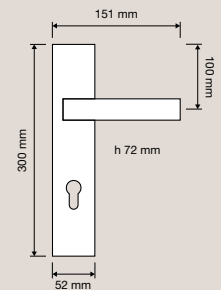
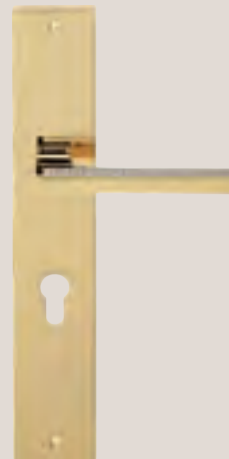

1301 DK
Maniglia per finestra
con movimento DK 4
posizioni / Window
handle with DK
movement 4 clicks

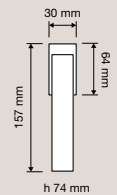

1301 SK
Maniglia per finestra
con movimento
DK SmartBlock /
Window handle
with DK SmartBlock
movement

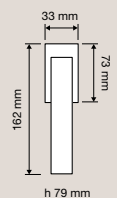

Sogno —

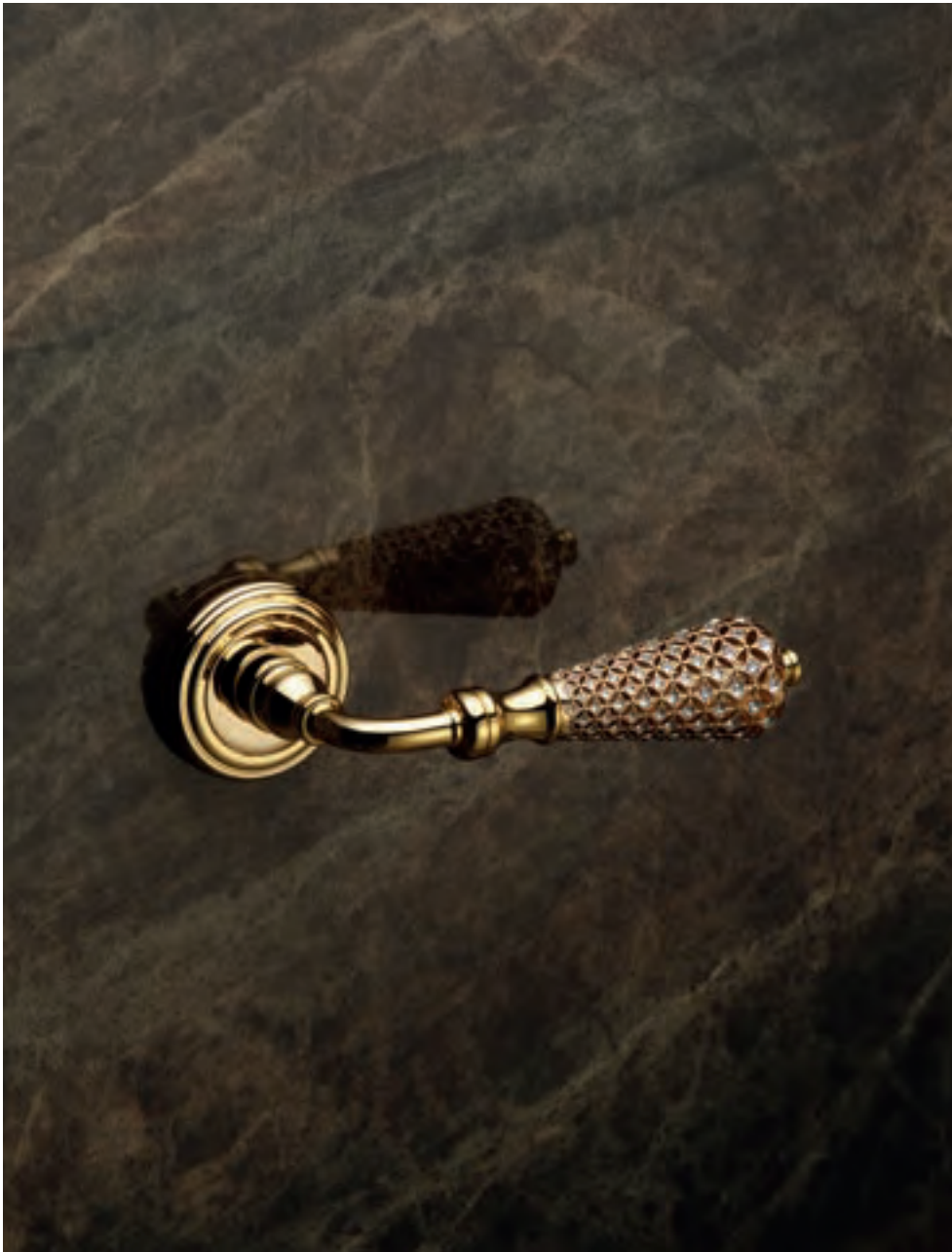

Finiture / Finishes



CR | Cromo lucido /
Polished chrome



OZ | Oro zecchino /
Gold plated

Cristalli / Crystals

Linea Cali utilizza
esclusivamente cristalli
Swarovski® originali.
*/ Linea Cali uses only
original Swarovski®
crystals.*



Affascinante ed elegante, permeata da forme classiche e intramontabili, pronta ad aprire le porte delle residenze più esclusive con la sua impugnatura tempestata di cristalli SWAROVSKI®.

Charming and elegant, permeated by classic and timeless shapes, ready to open the doors of the most exclusive residences with its handgrip studded with SWAROVSKI® crystals.

Collezione / Collection

1740 RB 011
Maniglia con rosetta
art.011 / Door handle
on rose art.011

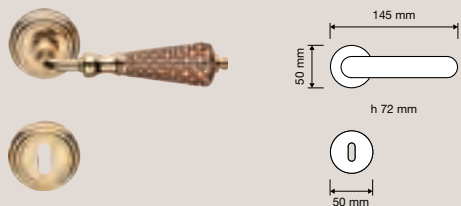

1740 PG 011
Pomolo a girare
con rosetta art.011
/ Turnable knob on
rose art.011



1740 PL
Maniglia con placca
art.1390 / Door
handle on plate
art.1390

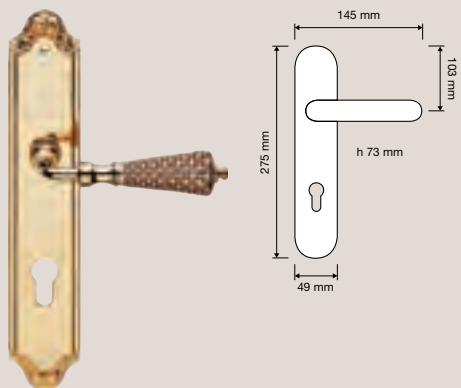

1740 MN 220 011
Maniglione con
rosette art.011 / Pull
handle on roses
art.011

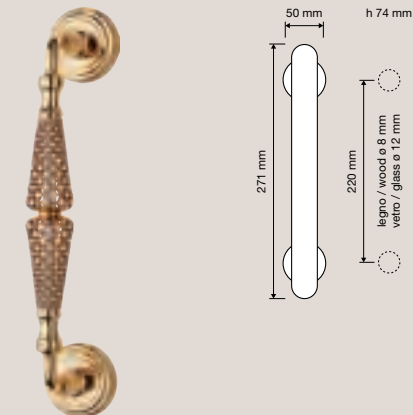

1740 DK
Maniglia per finestra
con movimento DK 4
posizioni / Window
handle with DK
movement 4 clicks

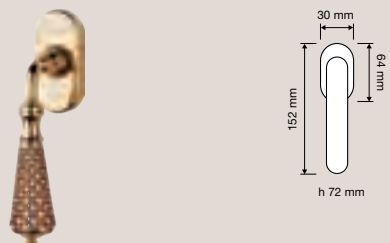

1740 PB 0033
Pomolo per mobile /
Cabinet knob

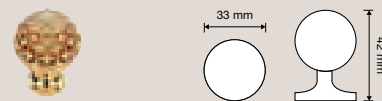

1740 SK
Maniglia per finestra
con movimento
DK SmartBlock /
Window handle
with DK SmartBlock
movement

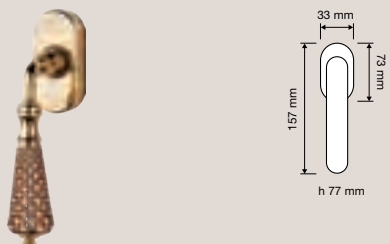

1740 PT 055
Pomolo a tirare con
rosetta art.011 /
Fixed knob on rose
art.011



Spirit Mesh



Finiture / Finishes



CR | Cromo lucido /
Polished chrome



CS | Cromo satinato /
Satin chrome



OZ | Oro zecchino /
Gold plated

Cristalli / Crystals

Linea Cali utilizza esclusivamente cristalli Swarovski® originali.
/ Linea Cali uses only original Swarovski® crystals.



Linee raffinate e sinuose disegnano una silhouette classica ma moderna, destinata a rimanere nel tempo.

Refined and sinuous lines produce a classical yet modern silhouette, destined to last over time.

Collezione / Collection

1451 RB 023
Maniglia con rosetta
art.023 / Door
handle on rose
art.023

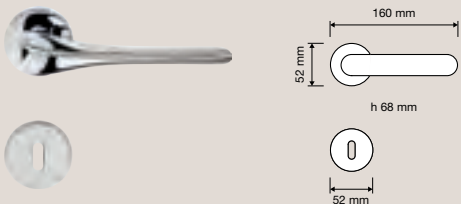

1451 RB 025
Maniglia con rosetta
art.025 / Door
handle on rose
art.025

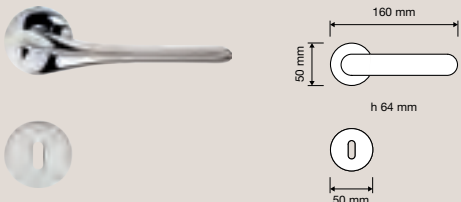

1453 PL
Maniglia con placca
art.1595 / Door
handle on plate
art.1595

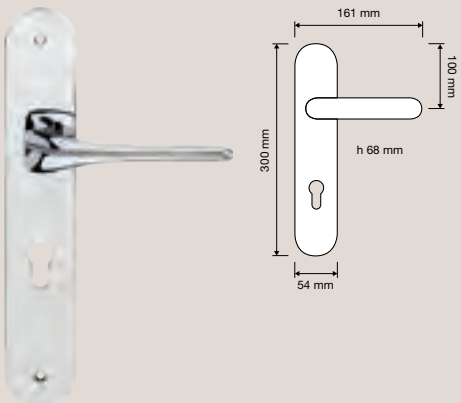

1451 DK
Maniglia per finestra
con movimento DK 4
posizioni / Window
handle with DK
movement 4 clicks

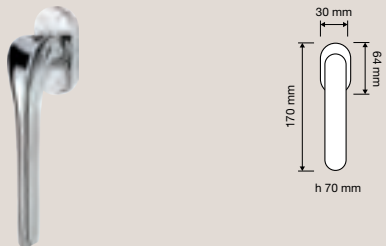

1451 SK
Maniglia per finestra
con movimento
DK SmartBlock /
Window handle
with DK SmartBlock
movement

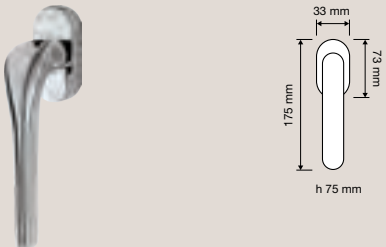

1451 MN 300
Maniglione / Pull
handle

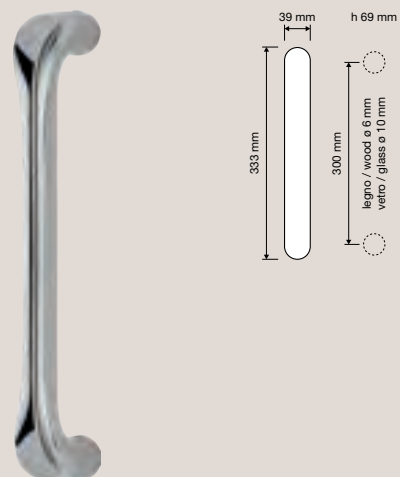

Tiffany Mesh



Finiture / Finishes



OF | Oro francese /
French gold



OZ | Oro zecchino /
Gold plated



PM | Patiné / Patiné
mat



TM | Peltro / Pewter

Cristalli / Crystals

Linea Cali utilizza
esclusivamente cristalli
Swarovski® originali.
/ Linea Cali uses only
original Swarovski®
crystals.



Due pavè di cristalli Swarovski®
accendono le forme con estrema
raffinatezza dando vita a una rilettura
contemporanea dello stile Tiffany più
autentico.

*A pavè of Swarovski® crystals
illuminates the forms with extreme
sophistication giving life to a
contemporary reinterpretation of the
most authentic Tiffany style.*

Collezione / Collection

1307 RB 018
Maniglia con rosetta
art.018 / Door handle
on rose art.018

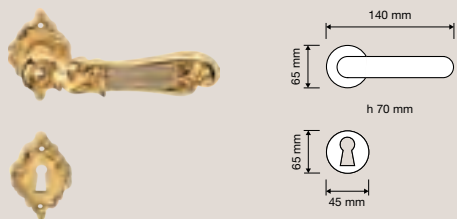

1307 RB 113
Maniglia con rosetta
art.113 / Door handle
on rose art.113

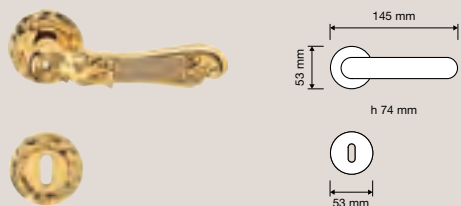

1307 PL
Maniglia con placca
Door handle on plate

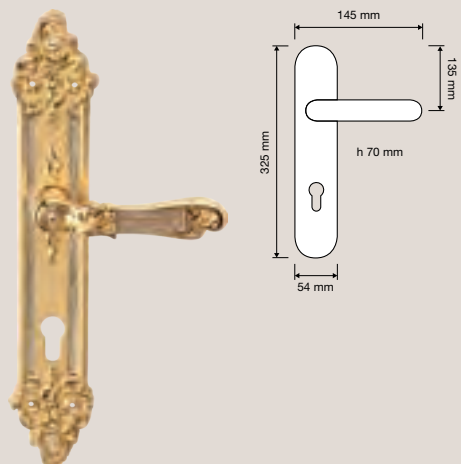

1307 CR
Cremonese /
Window handle grazz

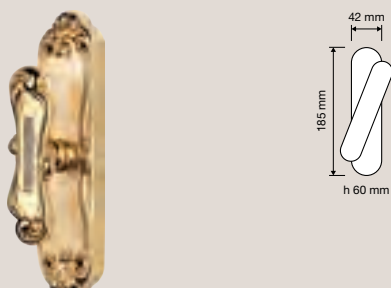

1307 DK
Maniglia per finestra
con movimento DK 4
posizioni / Window
handle with DK
movement 4 clicks



1307 PT
Pomolo a tirare /
Fixed knob



1307 PG 092
Pomolo a girare con
rosetta art.092 /
Turnable knob on
rose art.092



1307 MN 232
Maniglione / Pull
handle

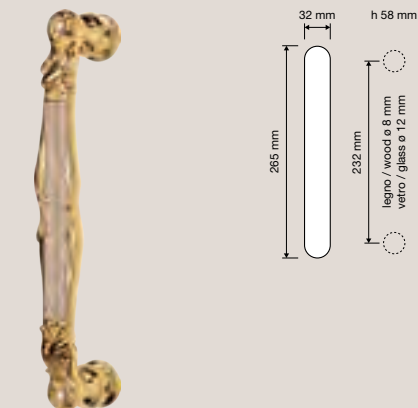

Veronica



Finiture / Finishes



CR | Cromo lucido /
Polished chrome



OZ | Oro zecchino /
Gold plated

Cristalli / Crystals

Linea Cali utilizza
esclusivamente cristalli
Swarovski® originali.
*/ Linea Cali uses only
original Swarovski®
crystals.*



Il fascino raffinato e discreto di questa
collezione di maniglie si rivela grazie
all'impugnatura a clessidra realizzata
interamente in cristallo Swarovski®.

*The refined and subtle fascination of
this collection of handles is revealed
thanks to the hourglass handgrip
made entirely of Swarovski® crystal.*

Collezione / Collection

900 RB 103
Maniglia con rosetta
art.103 / Door handle
on rose art.103

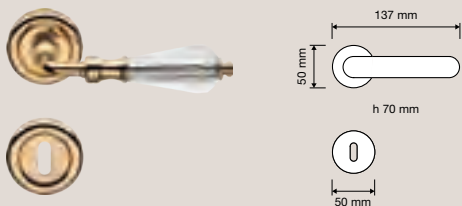

900 PG 103
Pomolo a girare
con rosetta art.103
/ Turnable knob on
rose art.103



900 PL
Maniglia con placca /
Door handle on plate

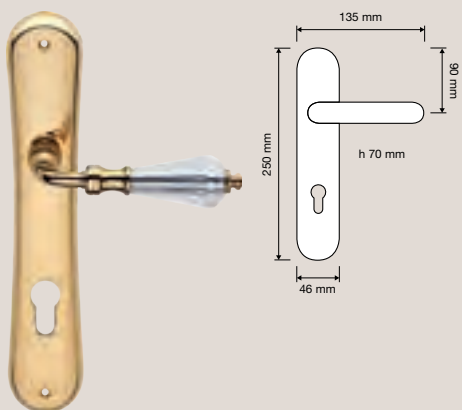

900 MN 208 103
Maniglia con
rosette art.103.
Attenzione:
l'interasse può
variare leggermente,
chiedere sempre
le misure prima di
forare la porta. /
Pull handle on roses
art.103. Attention:
the distance can
have little changes,
please always ask
before making the
holes in the door.

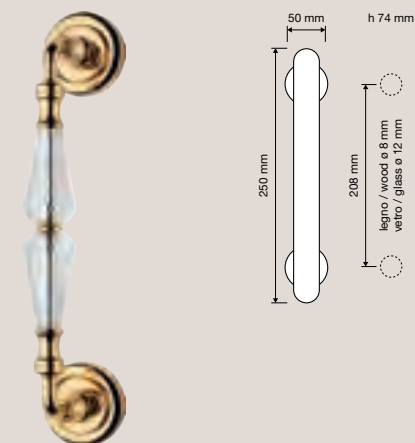

900 DK
Maniglia per finestra
con movimento DK 4
posizioni / Window
handle with DK
movement 4 clicks

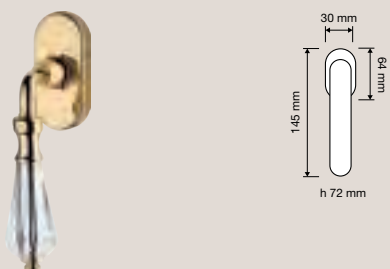

201 PB 0024
Pomolo per mobile /
Cabinet knob

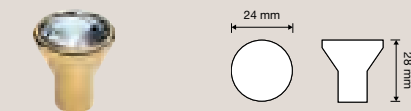

900 SK
Maniglia per finestra
con movimento
DK SmartBlock /
Window handle
with DK SmartBlock
movement

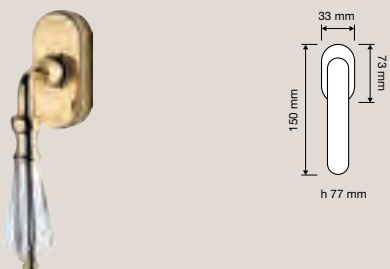

201 PB 0034
Pomolo per mobile /
Cabinet knob

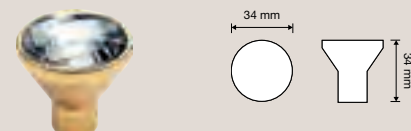

900 PT 080
Pomolo a tirare /
Fixed knob



Zen Mesh



Finiture / Finishes



CR | Cromo lucido /
Polished chrome



CS | Cromo satinato /
Satin chrome



OZ | Oro zecchino /
Gold plated

Cristalli / Crystals

Linea Cali utilizza esclusivamente cristalli Swarovski® originali.
/ Linea Cali uses only original Swarovski® crystals.



Una lunga striscia di piccolissimi cristalli Swarovski® sottolinea il design rigoroso di questa collezione, regalando una luminosità mai vista fino ad ora.

A long band of tiny Swarovski® crystals highlights the meticulous design of this collection, bestowing a radiance unseen until now.

Collezione / Collection

1157 RB 019
Maniglia con rosetta
art.019 / Door handle
on rose art.019

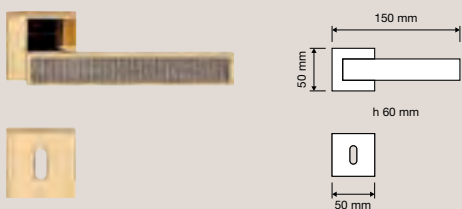

1157 PT 060
Pomolo a tirare /
Fixed knob



1157 RB 024
Maniglia con rosetta
art.024 / Door
handle on rose
art.024

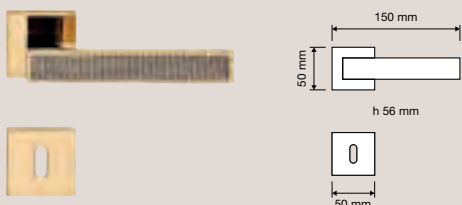

1157 PG 019
Pomolo a girare
con rosetta art.019
/ Turnable knob on
rose art.019

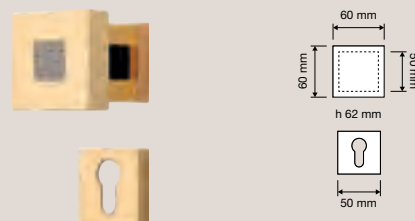

1151 PL
Maniglia con placca
art.1104 / Door
handle on plate
art.1104

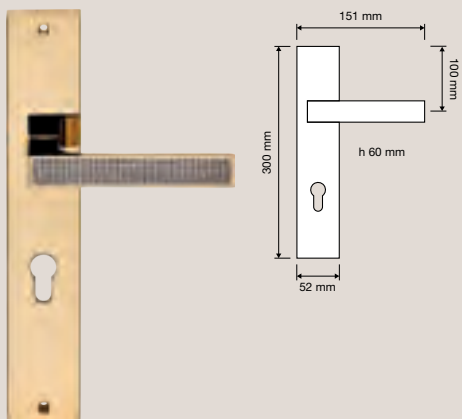

1157 MN 180
Maniglione / Pull
handle

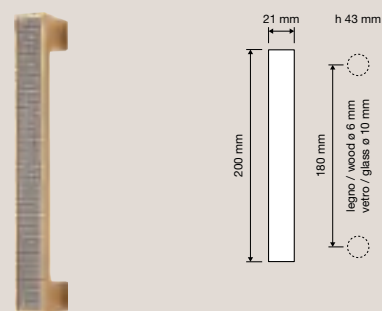

1157 DK
Maniglia per finestra
con movimento DK 4
posizioni / Window
handle with DK
movement 4 clicks



1157 MN 282
Maniglione / Pull
handle

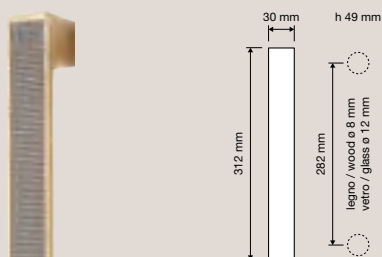

1157 SK
Maniglia per finestra
con movimento
DK SmartBlock /
Window handle
with DK SmartBlock
movement



1157 AB
Appendiabiti / Coat
hook



Collezione / Collection

302 FE
Fermaporta / Door
stop

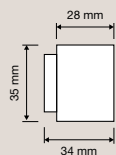

1578 FE
Fermaporta
magnetico quadro
/ Square magnetic
door stop

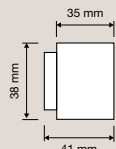

1151 ED/ES
Set d'entrata:
maniglia (dx o sx)
+ pomolo fisso e
maniglione con
placca art.1104 /
Entrance set: door
handle (right or left)
+ fixed knob and
pull handle on plate
art.1104

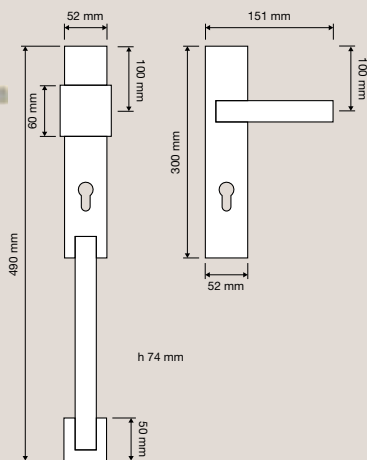



Le forme squadrate e rigorose mettono ulteriormente in risalto l'importante pavè di cristalli Swarovski®.

The square and rigorous shapes further highlight the important Swarovski® crystal pavè.

Vintage



Aida



Finiture / Finishes



NF | Nero francese /
French black



OF | Oro francese /
French gold



OZ | Oro zecchino /
Gold plated



PM | Patiné / Patiné
mat

L'anima spensierata e fantasiosa dello stile Luigi XV si riflette in questa elegante collezione di maniglie che nasce con l'intento di valorizzare ambienti arredati in stile classico particolarmente preziosi.

The carefree and imaginative soul of the Louis XV style is reflected in this elegant collection of handles that was created with the intention of enhancing particularly precious classically furnished rooms.

Collezione / Collection

1610 RB 005
Maniglia con rosetta
art.005 / Door
handle on rose
art.005

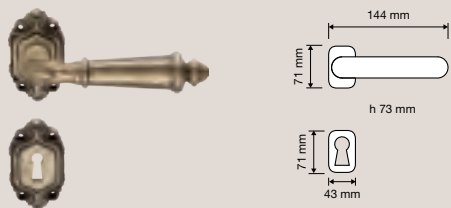

1610 MN 172 005
Maniglione con
rosette art.005 /
Pull handle on roses
art.005

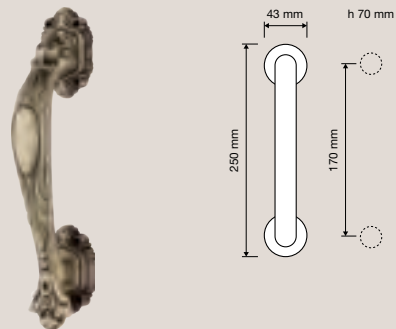

1611 PL
Maniglia con placca
Small / Door handle
on plate Small

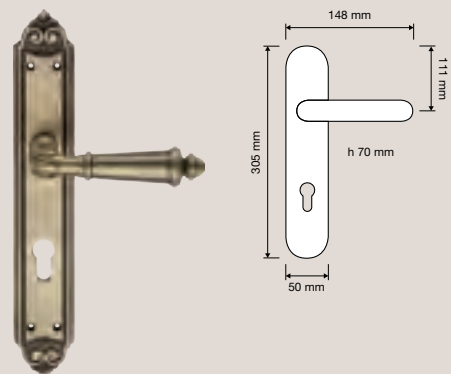

1610 SL
Maniglione su placca
Big / Pull handle on
plate Big

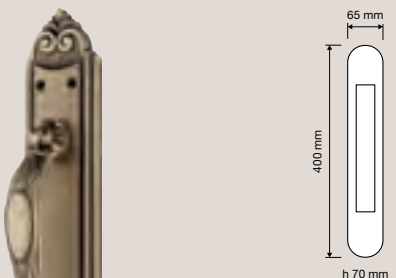

1610 PL
Maniglia con placca
Big / Door handle on
plate Big

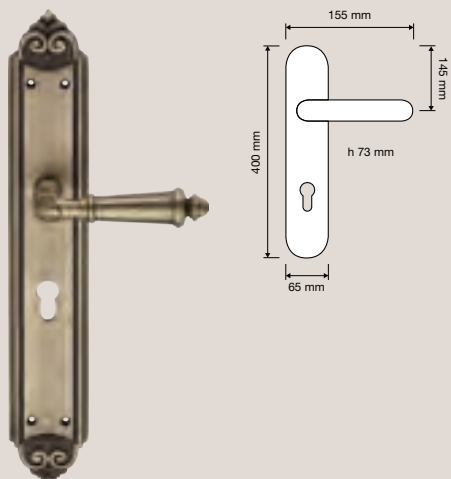

1611 IP
Placca incasso su
placca Small / Flush
pull on plate Small

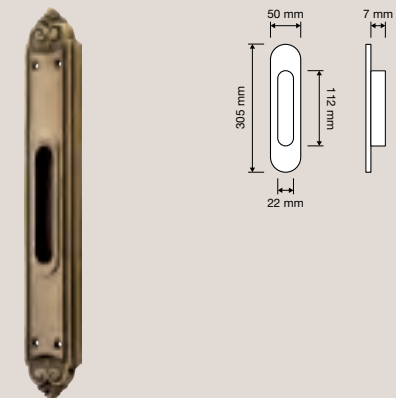

1610 DK
Maniglia per finestra
con movimento DK 4
posizioni / Window
handle with DK
movement 4 clicks

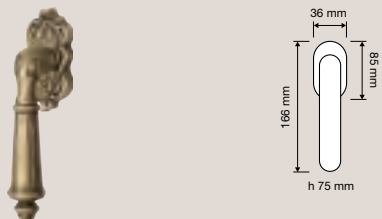

Aisha



Finiture / Finishes



NF | Nero francese /
French black



OF | Oro francese /
French gold



OZ | Oro zecchino /
Gold plated



PM | Patiné / *Patiné mat*

Le geometrie dell'architettura araba rifioriscono in questa armoniosa collezione, dove il collo della maniglia si sviluppa come un fiore che si schiude e un grande petalo forma l'impugnatura vera e propria.

The geometry of Arabic architecture is brought back to life in this harmonious collection, where the neck of the handle develops like a flower opening and a large petal forms the handgrip itself.

Collezione / Collection

1650 RB 112
Maniglia con rosetta
art.112 / Door handle
on rose art.112

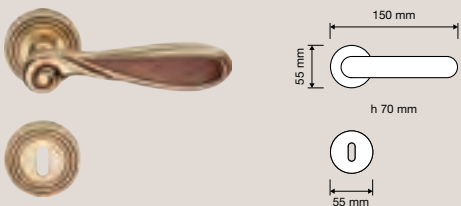

1650 RB 115
Maniglia con rosetta
art.115 / Door handle
on rose art.115

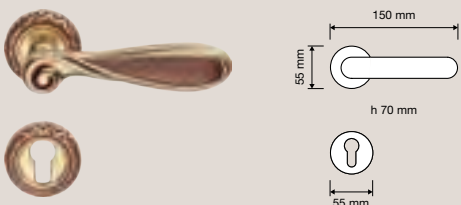

1650 PL
Maniglia con placca
Small / Door handle
on plate Small

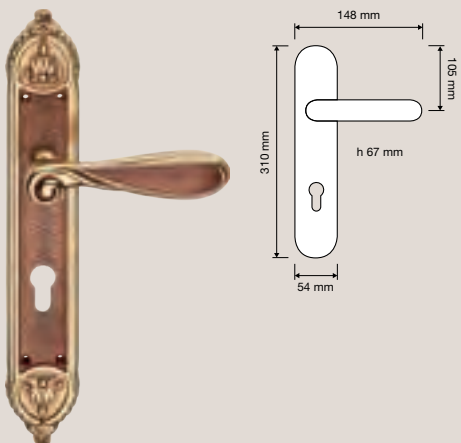

1651 PL
Maniglia con placca
Big / Door handle on
plate Big

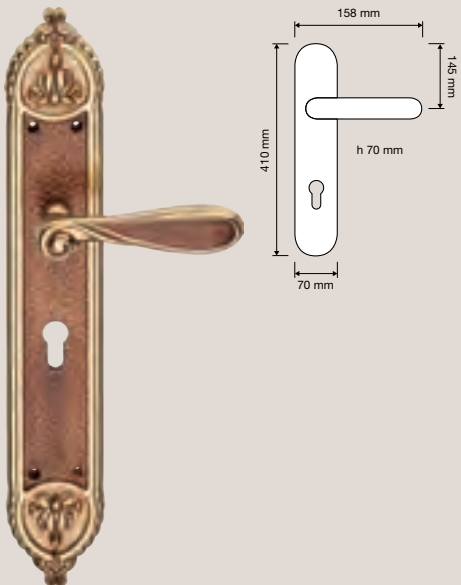

1650 DK
Maniglia per finestra
con movimento DK 4
posizioni / Window
handle with DK
movement 4 clicks



1650 SK
Maniglia per finestra
con movimento
DK SmartBlock /
Window handle
with DK SmartBlock
movement

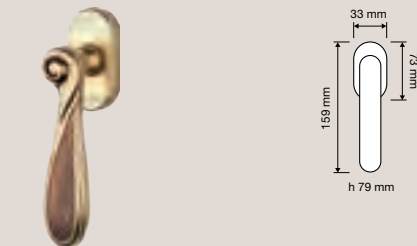

1650 PT
Pomolo a tirare /
Fixed knob



1651 FP
Pomolo fisso con
placca Big / Fixed
knob on plate Big

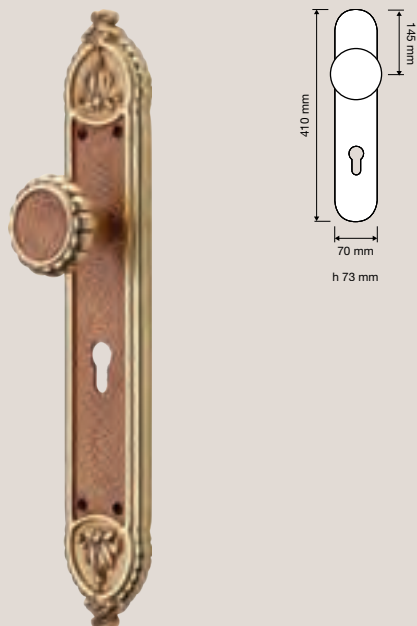

Collezione / Collection

1650 SL
Maniglione su placca
Small / Pull handle
on plate Small

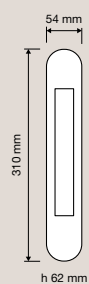

1651 SL
Maniglione su placca
Big / Pull handle on
plate Big

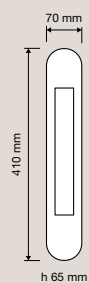



Un attento studio delle proporzioni ha dato vita a un particolare design che si sviluppa dal collo della maniglia come un fiore che si schiude, e un grande petalo a formare l'impugnatura vera e propria.

A careful study of proportions has given life to a particular design that develops from the neck of the handle like a flower opening and a large petal to form the handgrip itself.

Arcadia



Finiture / Finishes



NF | Nero francese /
French black



OF | Oro francese /
French gold



OZ | Oro zecchino /
Gold plated



PM | Patiné / Patiné
mat

Una sontuosa ghirlanda adorna questa maniglia che catalizza l'attenzione con le sue forme ricercate ed eleganti.

A sumptuous garland adorns this handles that captures our attention with its refined and elegant shapes.

Collezione / Collection

1640 RB 008
Maniglia con rosetta
art.008 / Door
handle on rose
art.008

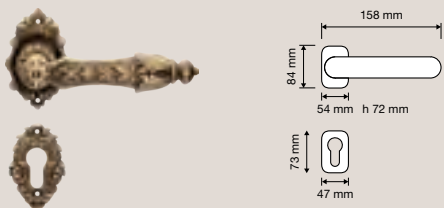

1640 RB 113
Maniglia con rosetta
art.113 / Door handle
on rose art.113

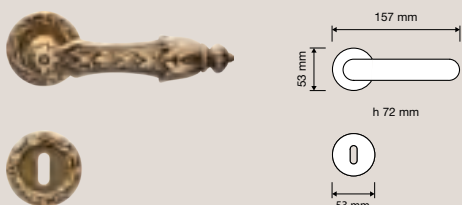

1640 PL
Maniglia con placca
Small art.1640 /
Door handle on plate
Small art.1640

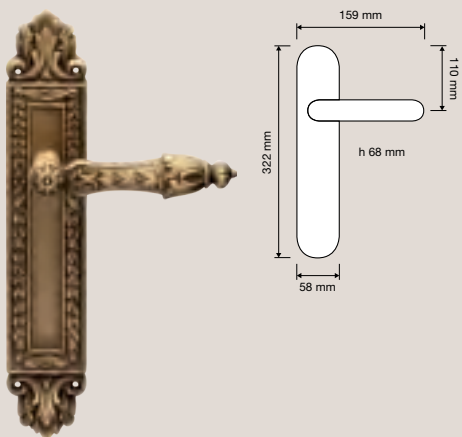

1641 PL
Maniglia con placca
Big art.1641 / Door
handle on plate Big
art.1641

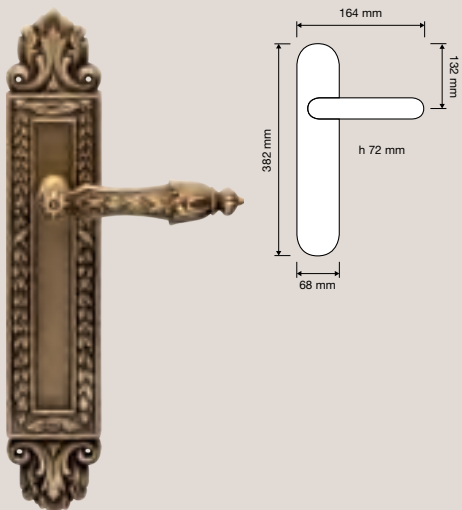

1640 DK
Maniglia per finestra
con movimento DK 4
posizioni / Window
handle with DK
movement 4 clicks



1640 MN 400
Maniglione. Interassi
disponibili 400-
500-600-800-1000-
2000. / Pull handle.
Available distances
400-500-600-800-
1000-2000.

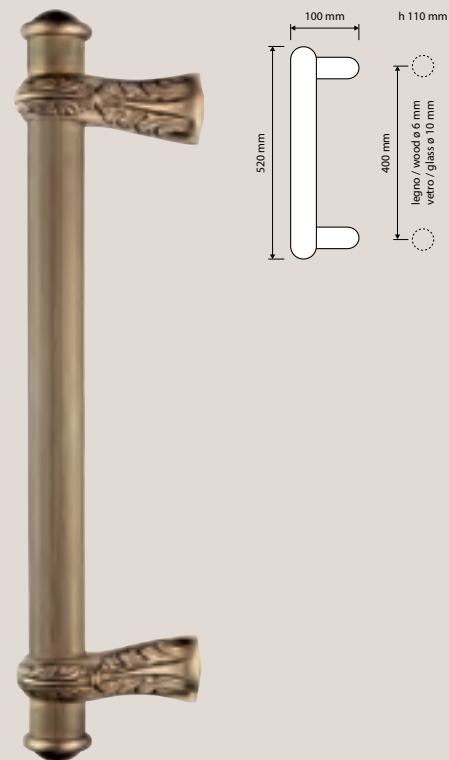

1641 SL
Maniglione su placca
Big art.1641 / Pull
handle on plate Big
art.1641





Finiture / Finishes



OF | Oro francese /
French gold



OZ | Oro zecchino /
Gold plated



PM | Patiné / Patiné
mat

Un bellissimo fiore dona grazia e maestosità a questa collezione Liberty ispirata alle opere di Alfons Mucha, pittore e scultore ceco che fu uno dei più importanti artisti dell'Art Nouveau.

A beautiful flower gives grace and majesty to this Liberty collection inspired by the works of Alfons Mucha, a Czech painter and sculptor, one of most important Art Nouveau artists.

Collezione / Collection

1165 RB 091
Maniglia con rosetta
art.091 / Door handle
on rose art.091

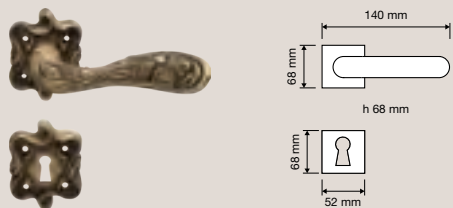

1165 RB 113
Maniglia con rosetta
art.113 / Door handle
on rose art.113

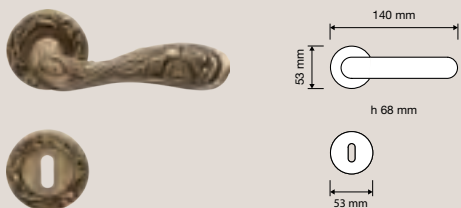

1165 PL
Maniglia con placca /
Door handle on plate

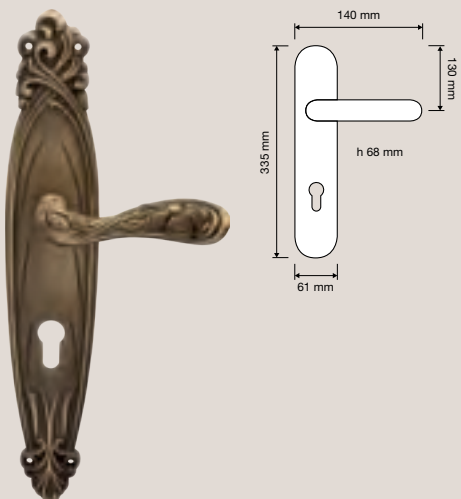

1165 DK
Maniglia per finestra
con movimento DK 4
posizioni / Window
handle with DK
movement 4 clicks

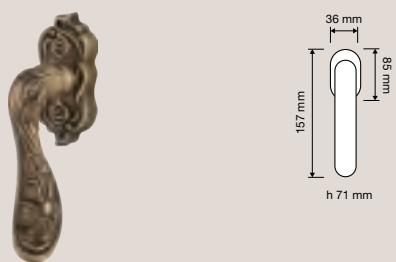

1165 MN 796
Maniglione. Interassi
disponibili 596-796-
896-1196. / Pull
handle. Available
distances 596-796-
896-1196.



Barocco —



Una collezione che meraviglia per la sua ricercatezza, frutto delle sapienti mani di artigiani italiani che trasformano un semplice pezzo di ottone in un prezioso accessorio d'arredo.

A collection that delights us with its panache, the results of the skilful hands of Italian artisans that transform a simple piece of brass into a precious furnishing accessory.

Collezione / Collection

Finiture / Finishes



OF | Oro francese /
French gold



OZ | Oro zecchino /
Gold plated



PM | Patiné / Patiné
mat

1520 RB 015
Maniglia con rosetta
art.015 / Door handle
on rose art.015

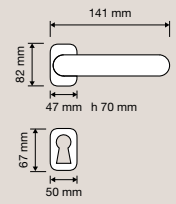

1520 RB 113
Maniglia con rosetta
art.113 / Door handle
on rose art.113

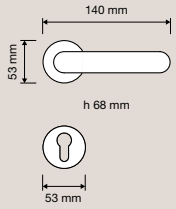

1520 PL
Maniglia con placca /
Door handle on plate

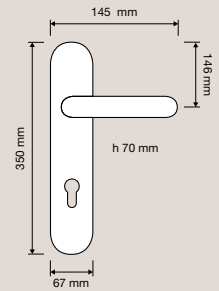

1520 DK
Maniglia per finestra
con movimento DK 4
posizioni / Window
handle with DK
movement 4 clicks

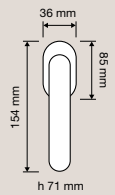

Charme _



L'estro dello stile barocco rivive grazie al sontuoso ornato di questa preziosa collezione che unisce la grande maestria della lavorazione artigianale italiana al design più autentico.

The flair of the Baroque style lives once more thanks to the sumptuous ornamentation of this precious collection that combines the great skill of Italian craftsmanship with the most authentic design.

Collezione / Collection

Finiture / Finishes



NF | Nero francese /
French black



OF | Oro francese /
French gold



OZ | Oro zecchino /
Gold plated



PM | Patiné / Patiné
mat

1590 RB 008
Maniglia con rosetta
art.008 / Door
handle on rose
art.008

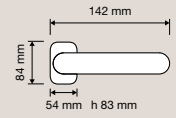

1590 RB 113
Maniglia con rosetta
art.113 / Door handle
on rose art.113

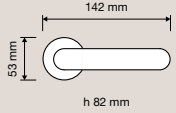

1590 PL
Maniglia con placca /
Door handle on plate

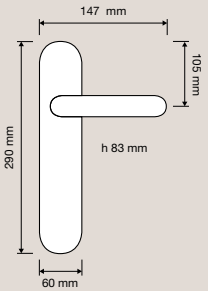

1590 DK
Maniglia per finestra
con movimento DK 4
posizioni / Window
handle with DK
movement 4 clicks

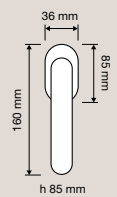

Chic



Finiture / Finishes



BM | Bronzo opaco /
Matt bronze



CR | Cromo lucido /
Polished chrome



CS | Cromo satinato /
Satin chrome



NL | Nickel lucido /
Polished nickel



OZ | Oro zecchino /
Gold plated



PM | Patiné / Patiné
mat

Linee circolari e smussature che richiamano allo stile classico danno vita a una maniglia -per paradosso- moderna dalla forte personalità in grado di coesistere con più stili nello stesso ambiente.

Circular lines and bevels that recall the classic style give life to a paradoxically modern handle with a strong personality capable of coexisting with multiple styles in the same environment.

Collezione / Collection

1670 RB 004
Maniglia con rosetta
art.004 / Door
handle on rose
art.004

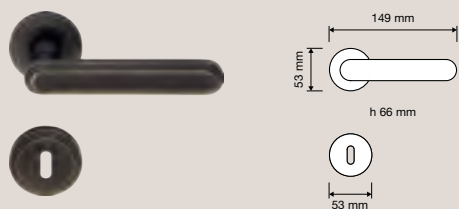

1670 PL
Maniglia con placca /
Door handle on plate

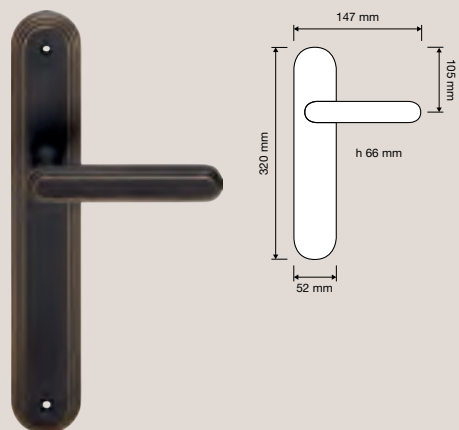

1670 DK
Maniglia per finestra
con movimento DK 4
posizioni / Window
handle with DK
movement 4 clicks

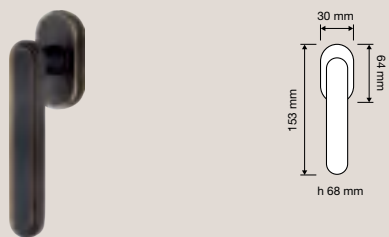

1670 SK
Maniglia per finestra
con movimento
DK SmartBlock /
Window handle
with DK SmartBlock
movement

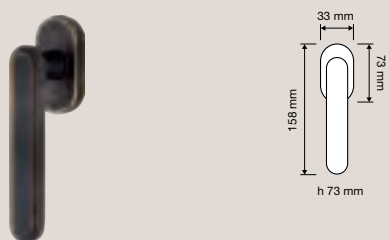

1670 PT
Pomolo a tirare con
rosetta art.004 /
Fixed knob on rose
art.004



1670 PG 004
Pomolo a girare con
rosetta art.004 /
Turnable knob on
rose art.004



1670 MN 400
Maniglione. Interassi
disponibili 300-400-
600. / Pull handle.
Available distances
300-400-600.

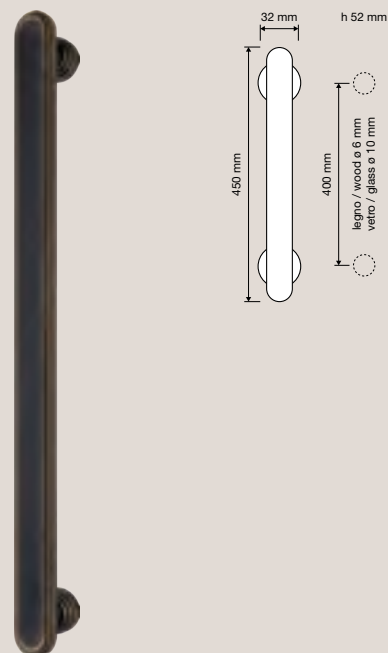

1670 IP
Placca incasso su
placca / Flush pull on
plate

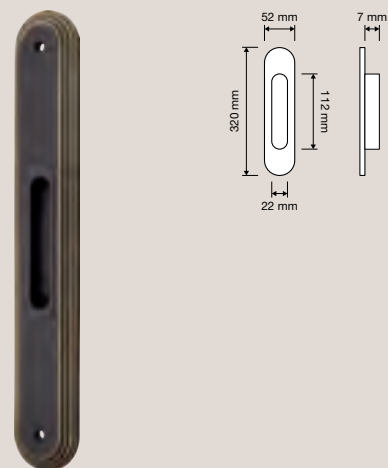

1670 PB 0024
Pomolo per mobile /
Cabinet knob

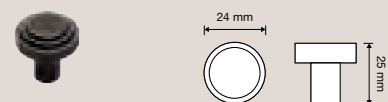

1670 PB 0034
Pomolo per mobile /
Cabinet knob

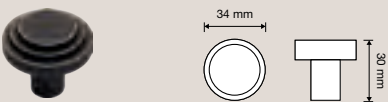

Daisy —



Finiture / Finishes



BM | Bronzo opaco /
Matt bronze



OB | Ottone bronzato
satinato / Bronzed
brass + satin brass



OF | Oro francese /
French gold



OZ | Oro zecchino /
Gold plated



PM | Patiné / Patiné
mat

Gli scenari per i Balletti Russi di Diaghilev riaffiorano alla mente in questa delicata rappresentazione dello stile Art Déco più autentico.

Scenes from the Russian Ballet of Diaghilev come to mind in this delicate representation of the most authentic Art Déco style.

Collezione / Collection

1070 RB 112
Maniglia con rosetta
art.112 / Door handle
on rose art.112

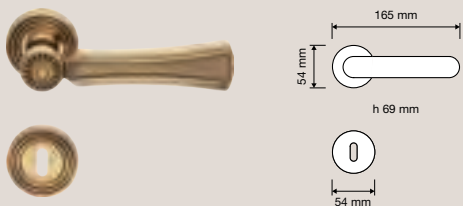

1070 PL
Maniglia con placca /
Door handle on plate

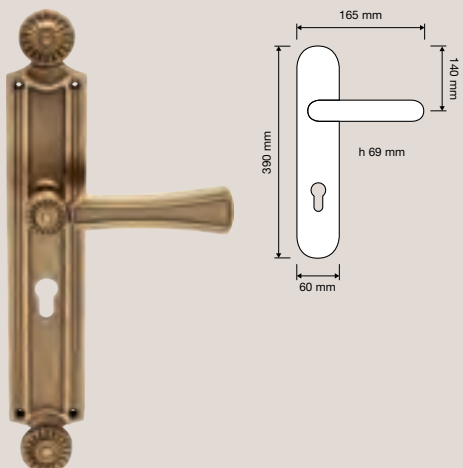

1070 DK
Maniglia per finestra
con movimento DK 4
posizioni / Window
handle with DK
movement 4 clicks

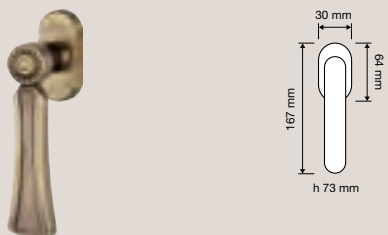

1070 SK
Maniglia per finestra
con movimento
DK SmartBlock /
Window handle
with DK SmartBlock
movement

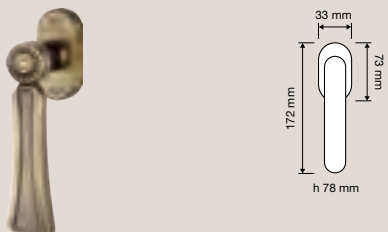

1070 PT 080
Pomolo a tirare /
Fixed knob



1070 FP
Pomolo fisso con
placca / Fixed knob
on plate

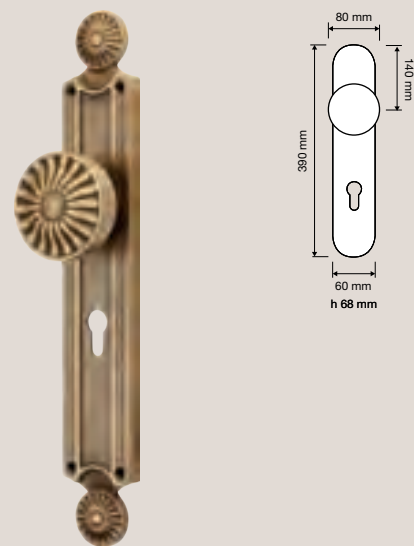

1070 MN 275 112
Maniglione con
rosette art.112 / Pull
handle on roses
art.112



1071 MN 207 114
Maniglione con
rosette art.114 / Pull
handle on roses
art.114

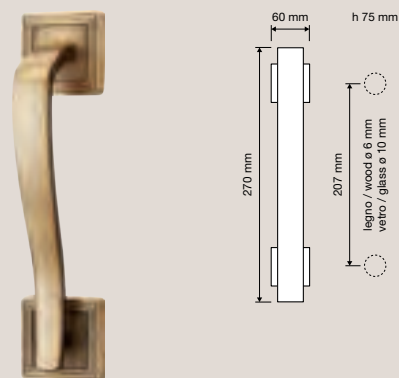

Collezione / Collection

1071 SL
Maniglione su placca
/ Pull handle on plate

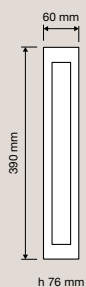

1070 ED/ES
Set d'entrata:
maniglia (dx o sx)
+ pomolo fisso e
maniglione con
placca / Entrance
set: door handle
(right or left) + fixed
knob and pull handle
on plate

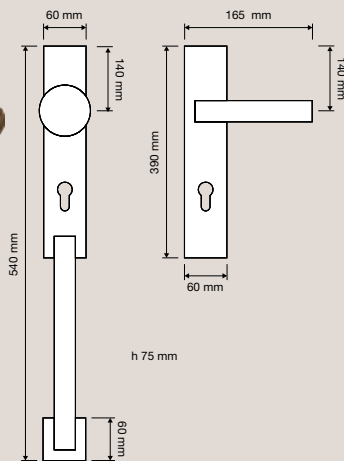

1070 PB 0030
Pomolo per mobile /
Cabinet knob

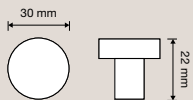



La maniglia con placca enfatizza ulteriormente lo stile Art Déco di questa aristocratica collezione contraddistinta da particolarissime lavorazioni manuali.

The handle with plate further emphasizes the Art Déco style of this aristocratic collection characterized by very special manual processes.

Epoca



Finiture / Finishes



OF | Oro francese /
French gold



OZ | Oro zecchino /
Gold plated



PM | Patiné / Patiné
mat

Il gusto lezioso e raffinato degli intarsi e gli eleganti rilievi in stile Luigi XVI caratterizzano questa collezione che evoca le magiche atmosfere della reggia di Versailles.

The precious and refined taste of the inlays and the elegant Louis XVI style reliefs characterize this collection that evokes the magic atmosphere of the Palace of Versailles.

Collezione / Collection

1210 RB 078
Maniglia con rosetta
art.078 / Door
handle on rose
art.078

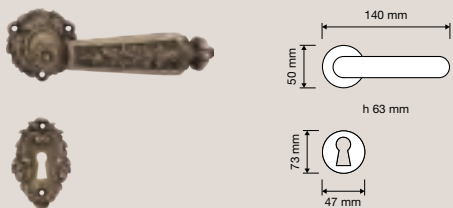

1210 PT 080
Pomolo a tirare /
Fixed knob



1210 PL
Maniglia con placca /
Door handle on plate

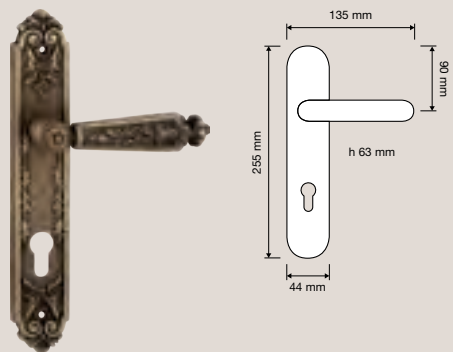

1210 PG 075
Pomolo a girare con
rosetta art.075 /
Turnable knob on
rose art.075



1210 CR
Cremonese /
Window handle gratz

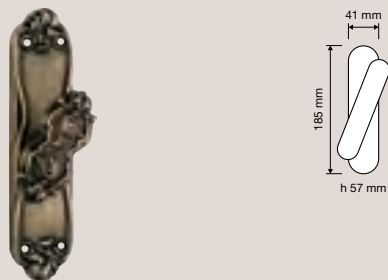

1210 MX
Maniglia per finestra
export quadro 7mm
/ Window handle
export 7mm square

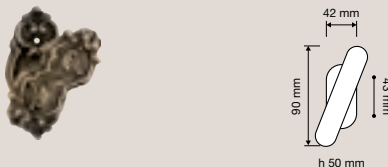

1210 DK
Maniglia per finestra
con movimento DK 4
posizioni / Window
handle with DK
movement 4 clicks



Frida



Finiture / Finishes



BM | Bronzo opaco /
Matt bronze



OF | Oro francese /
French gold



OZ | Oro zecchino /
Gold plated



PM | Patiné / Patiné
mat

Esuberante e all'avanguardia, con le sue forme rigorose e i fregi che ricordano i tratti di un gentil pennello di chissà quale artista.

Exuberant and avant-garde with its meticulous forms and friezes that recall the brush strokes of an artist.

Collezione / Collection

1700 RB 007
Maniglia con rosetta
art.007 / Door
handle on rose
art.007

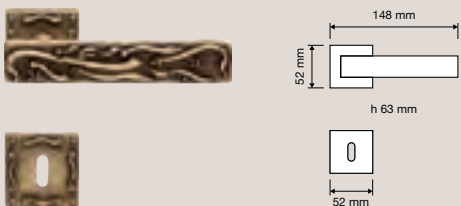

1700 PL
Maniglia con placca /
Door handle on plate

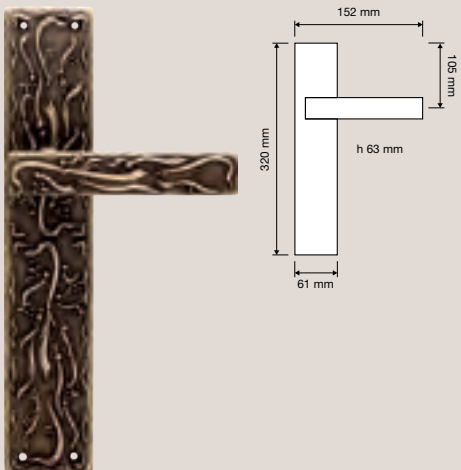

1700 PT 062
Pomolo a tirare con
rosetta art.007 /
Fixed knob on rose
art.007



1700 PG 007
Pomolo a girare con
rosetta art.007 /
Turnable knob on
rose art.007



1700 MN 300
Maniglione / Pull
handle

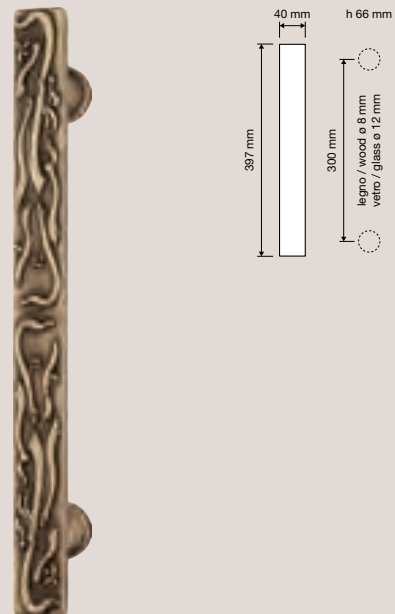

1700 PB 0031
Pomolo per mobile /
Cabinet knob



1700 MB 0096
Maniglietta per
mobile / Cabinet
handle



Glamor



Finiture / Finishes



BM | Bronzo opaco /
Matt bronze



CR | Cromo lucido /
Polished chrome



NL | Nickel lucido /
Polished nickel



OL | Ottone lucido
verniciato / *Polished
brass*



OZ | Oro zecchino /
Gold plated



PM | Patiné / *Patiné
mat*

L'arte della purificazione delle forme caratterizza questa collezione di maniglie, elegante e sofisticato esempio di design razionalista risalente al XX secolo.

The art of purifying shapes characterizes this collection of handles, an elegant and sophisticated example of the rationalist design dating back to the XX century.

Collezione / Collection

1555 RB 016
Maniglia con rosetta
art.016 / Door handle
on rose art.016

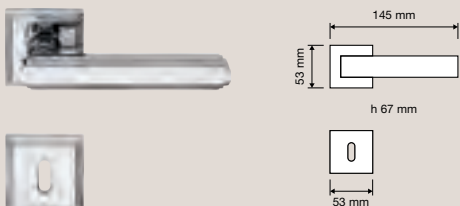

1555 PG 016
Pomolo a girare
con rosetta art.016
/ Turnable knob on
rose art.016



1555 PL
Maniglia con placca /
Door handle on plate

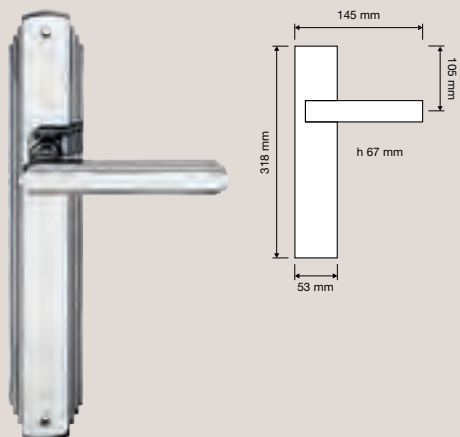

1555 MN 300
Maniglione. Interassi
disponibili 300-400-
600. / Pull handle.
Available distances
300-400-600.

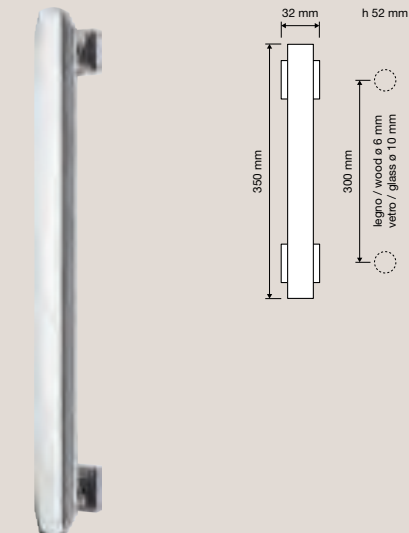

1555 DK
Maniglia per finestra
con movimento DK 4
posizioni / Window
handle with DK
movement 4 clicks



1555 IP
Placca incasso su
placca / Flush pull on
plate

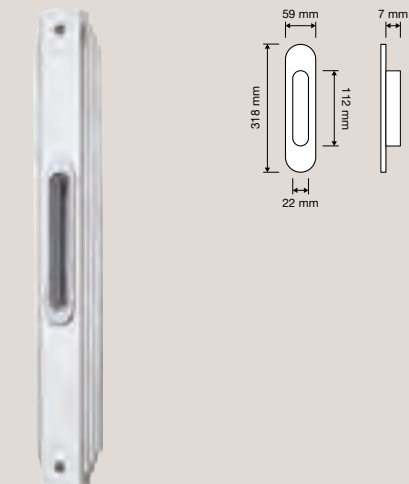

1555 SK
Maniglia per finestra
con movimento
DK SmartBlock /
Window handle
with DK SmartBlock
movement



1555 PT
Pomolo a tirare con
rosetta art.016 /
Fixed knob on rose
art.016



Jardin



Finiture / Finishes



NF | Nero francese /
French black



OF | Oro francese /
French gold



OZ | Oro zecchino /
Gold plated



PM | Patiné / Patiné
mat

Un tripudio di finissimi arabeschi floreali caratterizza questa collezione particolarmente elegante di chiara ispirazione Luigi XIV.

A triumph of fine floral arabesques characterizes this particularly elegant collection clearly inspired by Louis XIV.

Collezione / Collection

1560 RB 078
Maniglia con rosetta
art.078 / Door
handle on rose
art.078

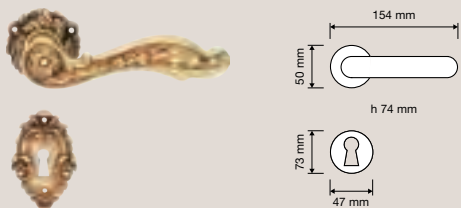

1560 RB 115
Maniglia con rosetta
art.115 / Door handle
on rose art.115

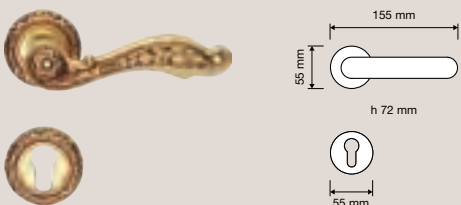

1560 PL
Maniglia con placca /
Door handle on plate

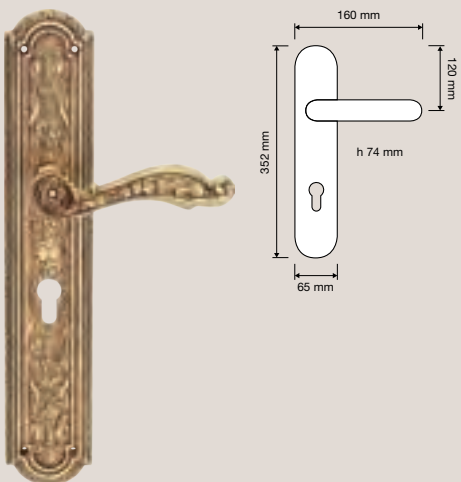

1562 PL
Maniglia con placca
Small art.1562 /
Door handle on plate
Small art.1562

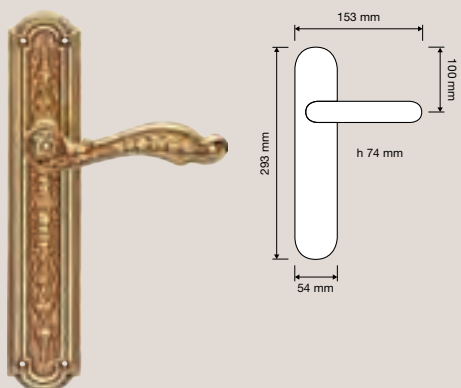

1560 DK
Maniglia per finestra
con movimento DK 4
posizioni / Window
handle with DK
movement 4 clicks



1560 MN 400
Maniglione. Interassi
disponibili 400-500-
600-700-800. / Pull
handle. Available
distances 400-500-
600-700-800.

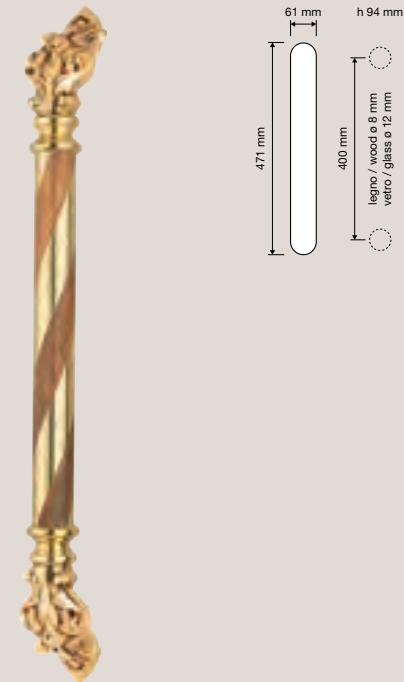

1560 SL
Maniglione su placca
/ Pull handle on plate

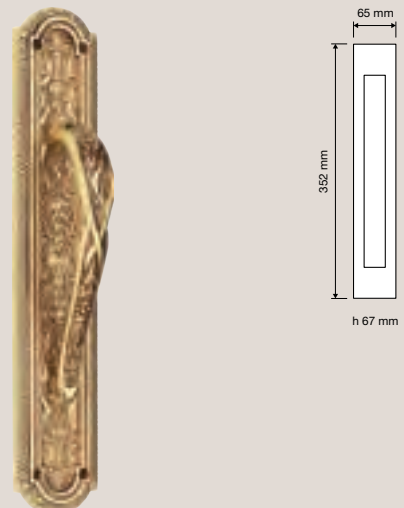

Collezione / Collection

1560 ED/ES
Set d'entrata:
maniglia (dx o sx)
+ pomolo fisso e
maniglione con
placca / Entrance
set: door handle
(right or left) + fixed
knob and pull handle
on plate

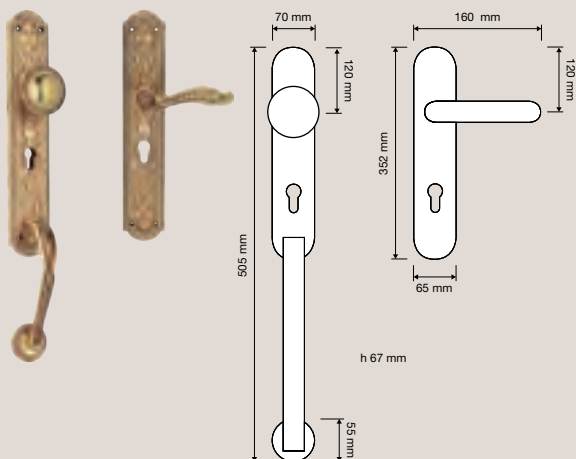



Particolarmente interessante è la maniglia su placca, interamente decorata con finissimi arabeschi floreali; questo si evince dai poetici motivi floreali che incorniciano il foro che ospita il cilindro della serratura.

The handle on the plate that is entirely decorated is of particular interest with a fine floral arabesque; this is clear from the poetic floral motifs that frame the hole that houses the lock cylinder.

Liberty —



Finiture / Finishes



OF | Oro francese /
French gold



OZ | Oro zecchino /
Gold plated



PM | Patiné / Patiné
mat



TM | Peltro / Pewter

Semplici figure di evidente ispirazione Liberty sembrano prendere vita ed evolversi naturalmente in forme simili a piante e fiori.

Simple figures clearly inspired by the Liberty style seem to come to life and evolve naturally into forms similar to plants and flowers.

Collezione / Collection

1160 RB 091
Maniglia con rosetta
art.091 / Door handle
on rose art.091

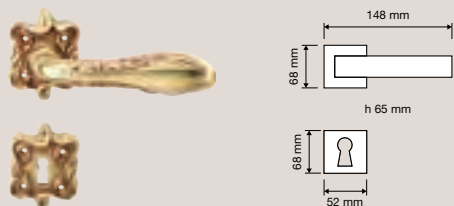

1160 RB 113
Maniglia con rosetta
art.113 / Door handle
on rose art.113

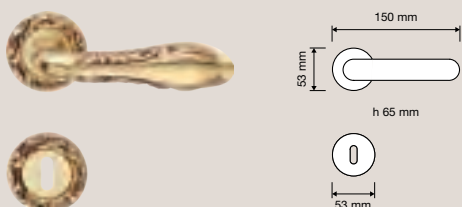

1160 PL
Maniglia con placca /
Door handle on plate

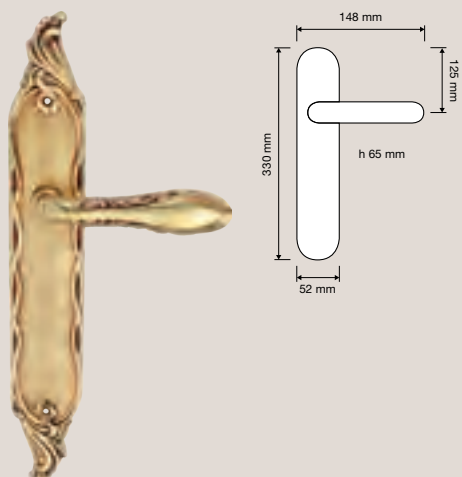

1160 CR
Cremonese /
Window handle gratz

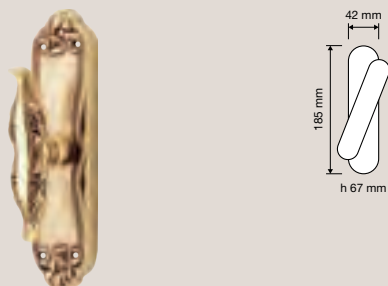

1160 MX
Maniglia per finestra
export quadro 7mm
/ Window handle
export 7mm square

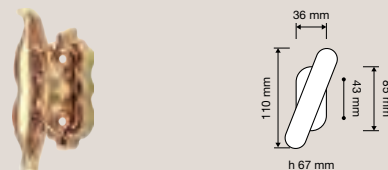

1160 DK
Maniglia per finestra
con movimento DK 4
posizioni / Window
handle with DK
movement 4 clicks



1160 PT 080
Pomolo a tirare /
Fixed knob



1160 PG 092
Pomolo a girare con
rosetta art.092 /
Turnable knob on
rose art.092



1161 MN 234
Maniglione / Pull
handle

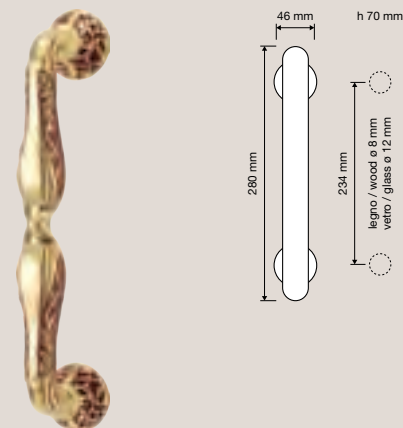

Collezione / Collection

1160 MN 380
Maniglione. Interassi disponibili 380-500-700. / Pull handle.
Available distances 380-500-700.

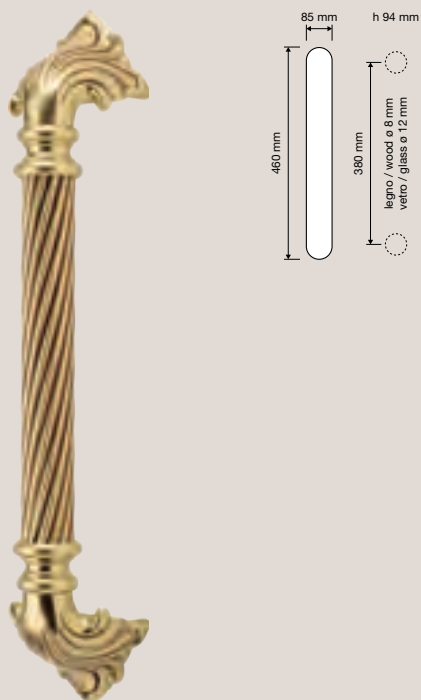

1160 CP
Rosetta art.092 con campanello / Rose art.092 with bell push



1160 PI
Placca incasso / Flush pull

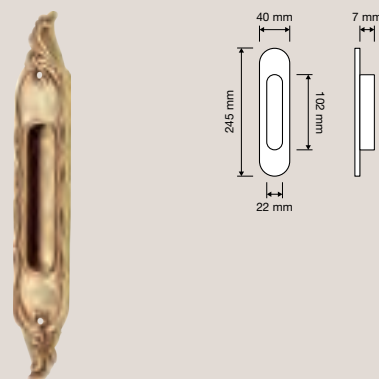

1162 MN 174 113
Maniglione con rosette art.113 / Pull handle on roses art.113

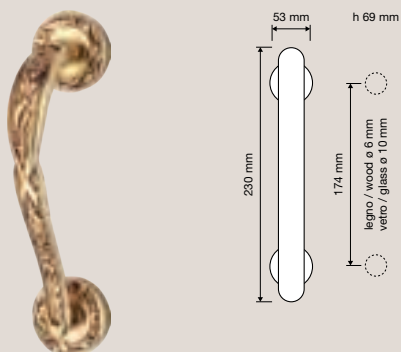

1160 AB
Appendiabiti / Coat hook



1160 BA
Battente / Door knocker

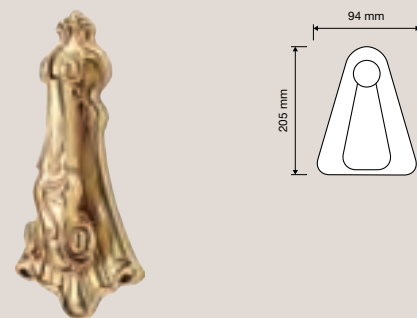

1162 ED/ES
Set d'entrata: maniglia (dx o sx) + pomolo fisso e maniglione con placca / Entrance set: door handle (right or left) + fixed knob and pull handle on plate

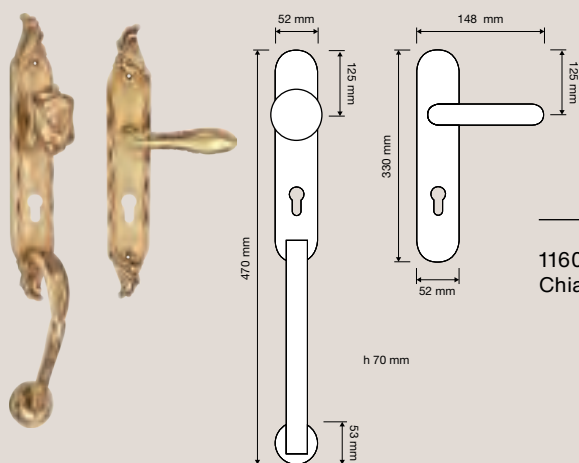

1160 CH
Chiave / Door key





Il minimo comun denominatore di questa collezione sono i preziosi fregi Art Nouveau che la contraddistinguono grazie a un'accentuata eleganza decorativa e da linee dolci e sinuose che si intrecciano armoniosamente.

The minimum common denominator of this collection are the precious Art Nouveau friezes that distinguish it by an accentuated decorative elegance and by sweet and sinuous lines that intertwine harmoniously.

Nature _



Lo stile Liberty, privilegio delle più alte classi sociali di un tempo, è qui rappresentato in un trionfo di nervature filiformi di chiara ispirazione vegetale.

The Liberty style, a privilege for the highest social classes of the past, is represented here in a triumph of filiform ribs, clearly inspired by nature.

Collezione / Collection

Finiture / Finishes



OF | Oro francese /
French gold



OZ | Oro zecchino /
Gold plated



PM | Patiné / Patiné
mat

1320 RB 018
Maniglia con rosetta
art.018 / Door handle
on rose art.018

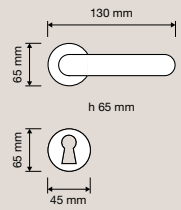

1320 RB 113
Maniglia con rosetta
art.113 / Door handle
on rose art.113

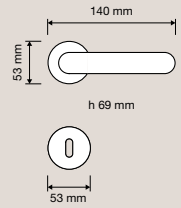

1320 PL
Maniglia con placca /
Door handle on plate

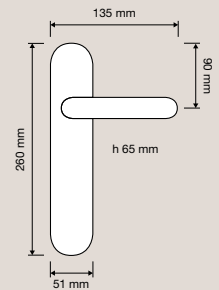

1320 DK
Maniglia per finestra
con movimento DK 4
posizioni / Window
handle with DK
movement 4 clicks

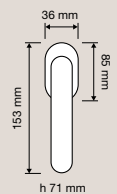

Ninfa



Finiture / Finishes



OF | Oro francese /
French gold



OZ | Oro zecchino /
Gold plated



PM | Patiné / Patiné
mat

Una collezione classica, facile da abbinare, che arricchisce ogni ambiente con il suo stile vintage particolarmente elegante e sobrio.

A classical collection, easy to match, that elevates every environment with its particularly elegant and sober style.

Collezione / Collection

1540 RB 015
Maniglia con rosetta
art.015 / Door handle
on rose art.015

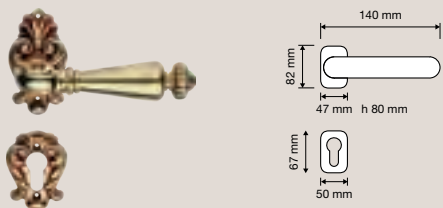

1540 RB 113
Maniglia con rosetta
art.113 / Door handle
on rose art.113

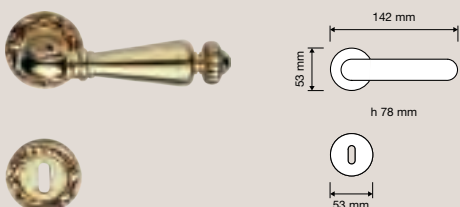

1540 PL
Maniglia con placca
art.1395 / Door
handle on plate
art.1395

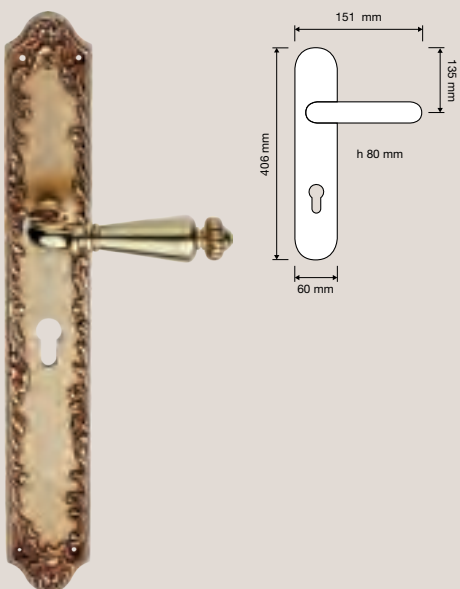

1541 PL
Maniglia con placca
art.1397 / Door
handle on plate
art.1397

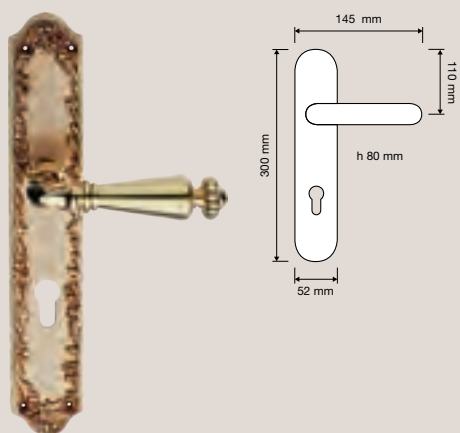

1540 DK
Maniglia per finestra
con movimento DK 4
posizioni / Window
handle with DK
movement 4 clicks



1540 PT
Pomolo a tirare /
Fixed knob



1540 PG
Pomolo a girare con
rosone art.1540 /
Turnable knob on big
rose art.1540



1540 MN 228
Maniglione / Pull
handle

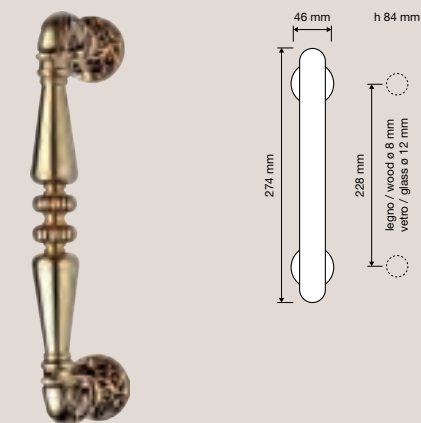

Ninfa Porcellana



Finiture / Finishes



OF | Oro francese /
French gold



OZ | Oro zecchino /
Gold plated



PM | Patiné / Patiné
mat

L'impugnatura in preziosa porcellana contraddistingue questa collezione che dona un tocco delicatamente vintage agli ambienti contemporanei.

The handgrip in precious porcelain distinguishes this collection, which gives a delicately vintage touch to contemporary environments.

Collezione / Collection

1546 RB 015
Maniglia con rosetta
art.015 / Door handle
on rose art.015

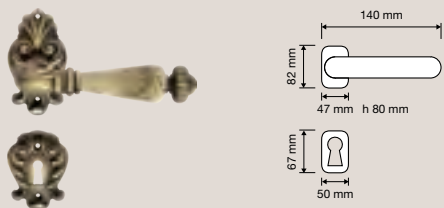

1546 RB 113
Maniglia con rosetta
art.113 / Door handle
on rose art.113

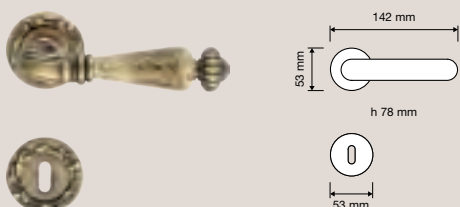

1546 PL
Maniglia con placca
art.1395 / Door
handle on plate
art.1395

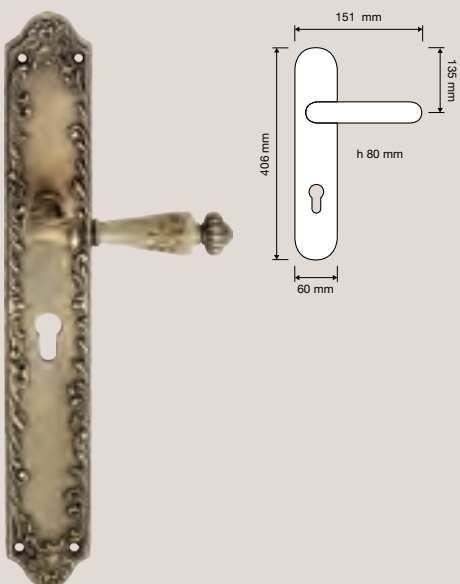

1547 PL
Maniglia con placca
art.1397 / Door
handle on plate
art.1397

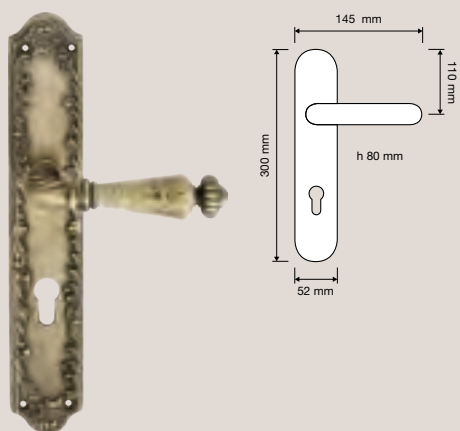

1546 DK
Maniglia per finestra
con movimento DK 4
posizioni / Window
handle with DK
movement 4 clicks



1546 MN 228
Maniglione / Pull
handle

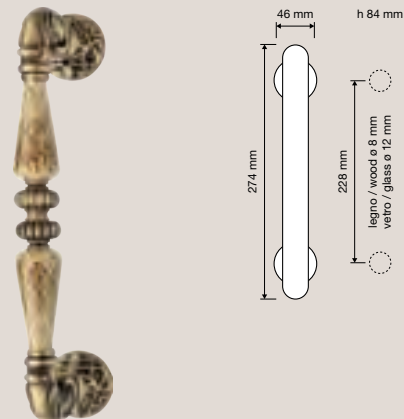

Opera



Finiture / Finishes



BM | Bronzo opaco /
Matt bronze



OB | Ottone bronzato
satinato / Bronzed
brass + satin brass



OF | Oro francese /
French gold



OZ | Oro zecchino /
Gold plated



PM | Patiné / Patiné
mat

Le forme severe del Neoclassicismo infondono uno stile rigoroso a questa collezione, caratterizzata da linee orizzontali e verticali che sottolineano l'imponenza del design.

The severe forms of Neoclassicism instil a meticulous style in this collection, characterised by horizontal and vertical lines that highlight the grandeur of the design.

Collezione / Collection

1055 RB 112
Maniglia con rosetta
art.112 / Door handle
on rose art.112

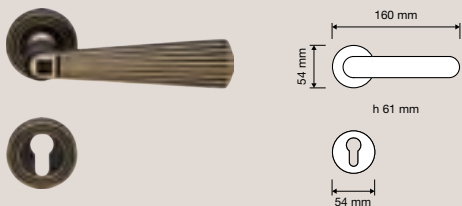

1055 PT 070
Pomolo a tirare /
Fixed knob



1055 RB 114
Maniglia con rosetta
art.114 / Door handle
on rose art.114

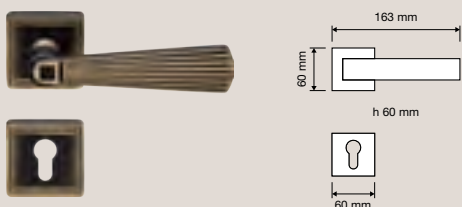

1055 FP
Pomolo fisso con
placca / Fixed knob
on plate

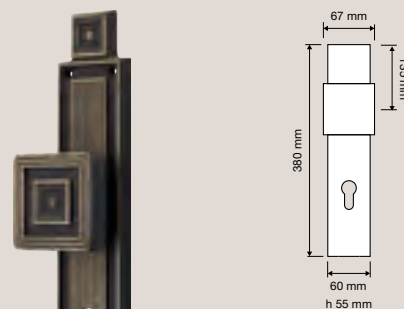

1055 PL
Maniglia con placca /
Door handle on plate

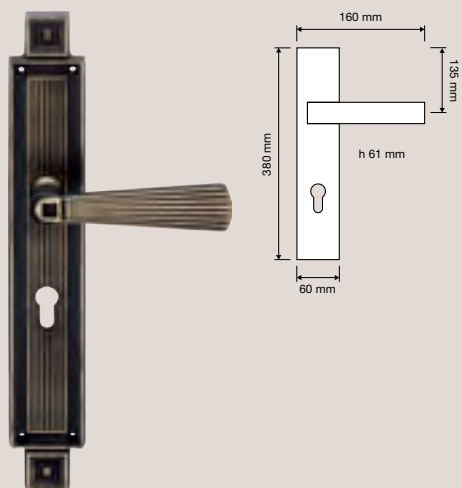

1055 MN 240
Maniglione / Pull
handle

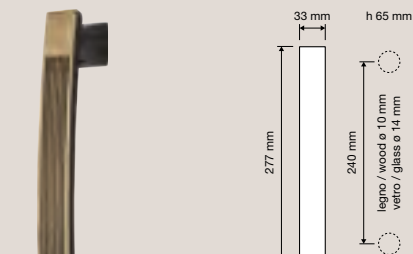

1055 DK
Maniglia per finestra
con movimento DK 4
posizioni / Window
handle with DK
movement 4 clicks



1055 SK
Maniglia per finestra
con movimento
DK SmartBlock /
Window handle
with DK SmartBlock
movement



Collezione / Collection

1055 AP
Maniglione
accoppiato su placca
/ Set pull handles on plate

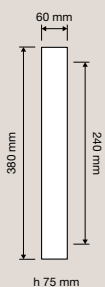

1055 ED/ES
Set d'entrata:
maniglia (dx o sx)
+ pomolo fisso e
maniglione con
placca / *Entrance set:
door handle (right or
left) + fixed knob and
pull handle on plate*

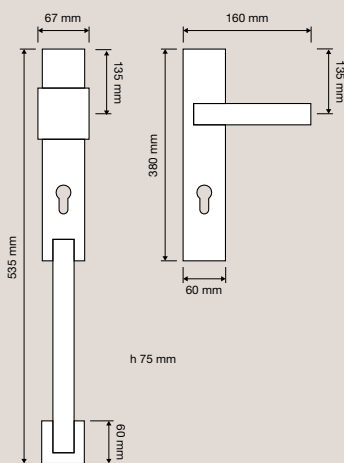

1055 KD/KS
Maniglia (dx o sx)
+ pomolo fisso con
placca / *Door handle
(right or left) + fixed
knob on plate*

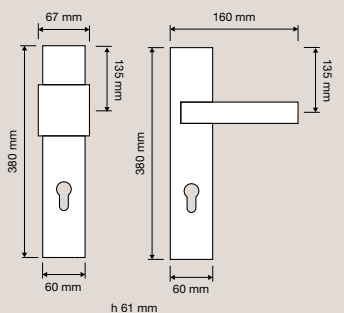



La versione con placca è l'apoteosi dello stile Neoclassico che trae ispirazione dall'architettura greca e romana.

The version with plate is the apotheosis of the Neoclassical style that draws inspiration from Greek and Roman architecture.

Poesia



Finiture / Finishes



OF | Oro francese /
French gold



OZ | Oro zecchino /
Gold plated



PM | Patiné / Patiné
mat

Un omaggio allo stile Liberty più autentico, caratterizzato da motivi ispirati alla natura che avvolgono completamente ogni forma rendendola "viva".

A tribute to the most authentic Liberty style, characterised by themes inspired by nature that completely envelop every form making them come "alive".

Collezione / Collection

1395 RB 015
Maniglia con rosetta
art.015 / Door handle
on rose art.015

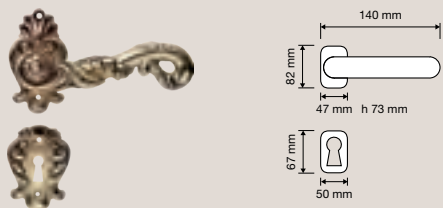

1395 DK
Maniglia per finestra
con movimento DK 4
posizioni / Window
handle with DK
movement 4 clicks

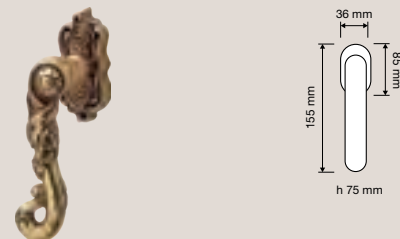

1395 RB 113
Maniglia con rosetta
art.113 / Door handle
on rose art.113

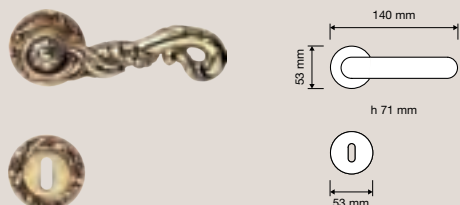

1395 SL
Maniglione su placca
/ Pull handle on plate

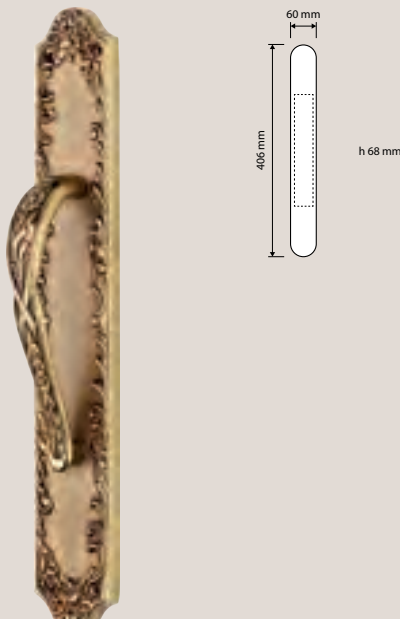

1395 PL
Maniglia con placca
art.1395 / Door
handle on plate
art.1395

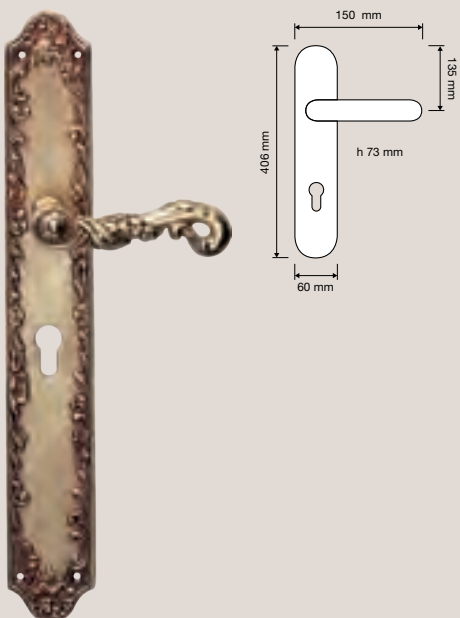

1397 PL
Maniglia con placca
art.1397 / Door
handle on plate
art.1397

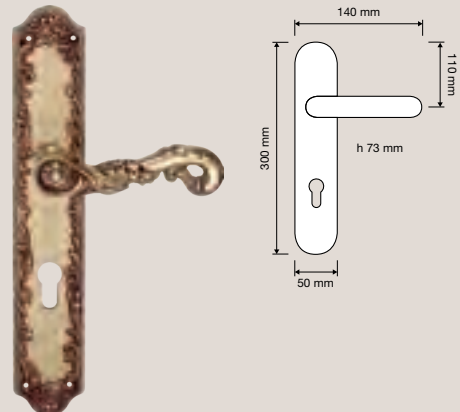

Queen



Finiture / Finishes



OF | Oro francese /
French gold



OZ | Oro zecchino /
Gold plated



PM | Patiné / *Patiné
mat*

Esuberanti rilievi ornamentali, sfoggio della tradizione ebanistica francese, fanno rivivere l'indiscutibile fascino dello stile barocco più autentico.

Exuberant ornamental reliefs, a display of traditional French cabinet making, revive the unquestionable charm of the authentic Baroque style.

Collezione / Collection

1406 RB 015
Maniglia Small con
rosetta art.015 /
Small door handle on
rose art.015

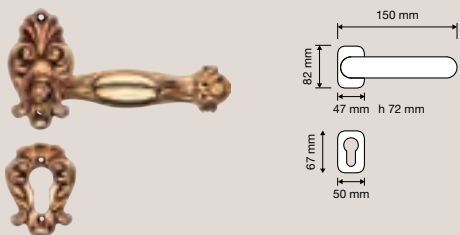

1406 DK
Maniglia Small
per finestra con
movimento DK 4
posizioni / Window
small handle with DK
movement 4 clicks



1406 RB 113
Maniglia Small con
rosetta art.113 /
Small door handle on
rose art.113

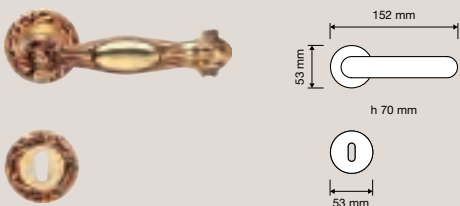

1405 PT
Pomolo a tirare /
Fixed knob



1405 PL
Maniglia con placca /
Door handle on plate

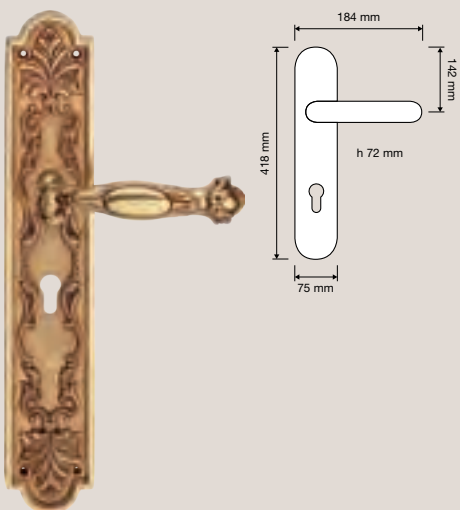

1405 FP
Pomolo fisso con
placca / Fixed knob
on plate

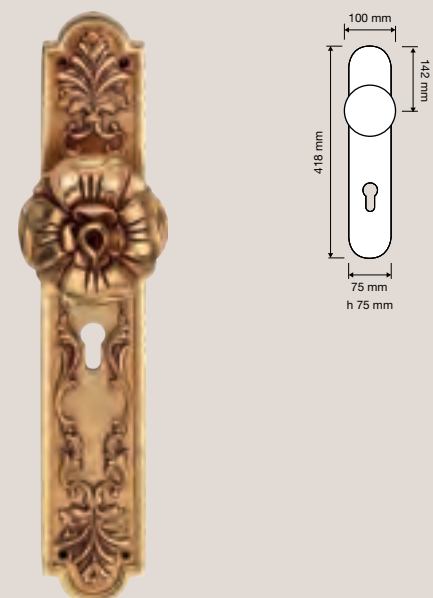

1406 PL
Maniglia Small con
placca / Small door
handle on plate

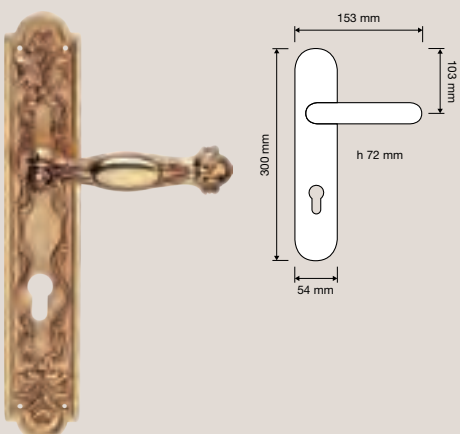

Collezione / Collection

1405 MN 315
Maniglione / Pull
handle

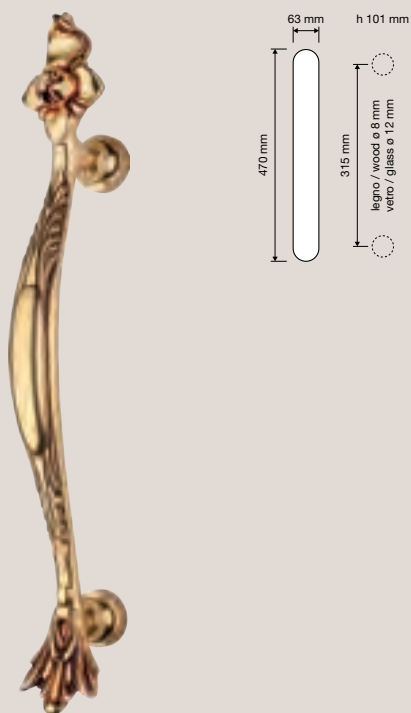

1408 MN 723
Maniglione Crystal.
Attenzione:
l'interasse può
variare leggermente,
chiedere sempre
le misure prima di
forare la porta. /
Crystal pull handle.
Attention: the
distance can have
little changes, please
always ask before
making the holes in
the door.

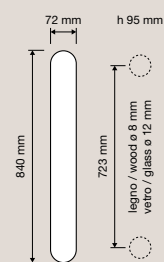

1405 KD/KS
Maniglia (dx o sx)
+ pomolo fisso con
placca / Door handle
(right or left) + fixed
knob on plate

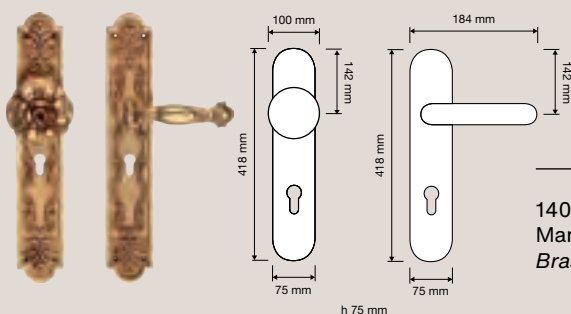

1407 MN 738
Maniglione Brass /
Brass pull handle

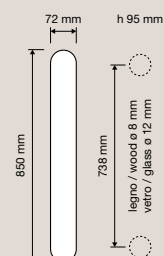



La grandezza e i fasti del Seicento francese sono evocati da motivi importanti. Imponente ed elegante, Queen è il più grande omaggio allo stile Barocco mai realizzato da Linea Cali.

The grandeur and splendour of Seventeenth Century France are evoked by important motifs. Imposing and elegant, Queen is the greatest tribute to the Baroque style ever to be created by Linea Cali.

Rococò



Finiture / Finishes



OF | Oro francese /
French gold



OZ | Oro zecchino /
Gold plated



PM | Patiné / Patiné
mat

La rappresentazione del gusto francese per l'arte, evoluzione dello stile tardo-barocco e tipica rappresentazione della vita aristocratica di allora.

The representation of the French taste in art, evolution of the late-Baroque style and typical representation of the aristocratic life of bygone days.

Collezione / Collection

1285 RB 078
Maniglia con rosetta
art.078 / Door
handle on rose
art.078

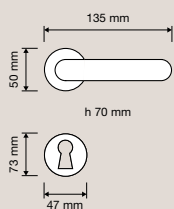
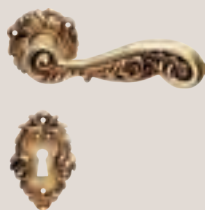

1285 PL
Maniglia con placca /
Door handle on plate

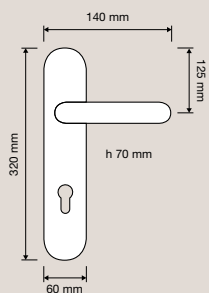

1285 DK
Maniglia per finestra
con movimento DK 4
posizioni / Window
handle with DK
movement 4 clicks

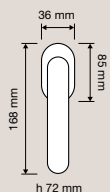

1285 PT
Pomolo a tirare /
Fixed knob

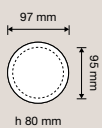

1285 MN 400
Maniglione. Interassi
disponibili 400-500-
600. / Pull handle.
Available distances
400-500-600.

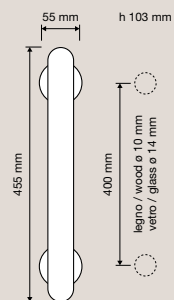

Sissi

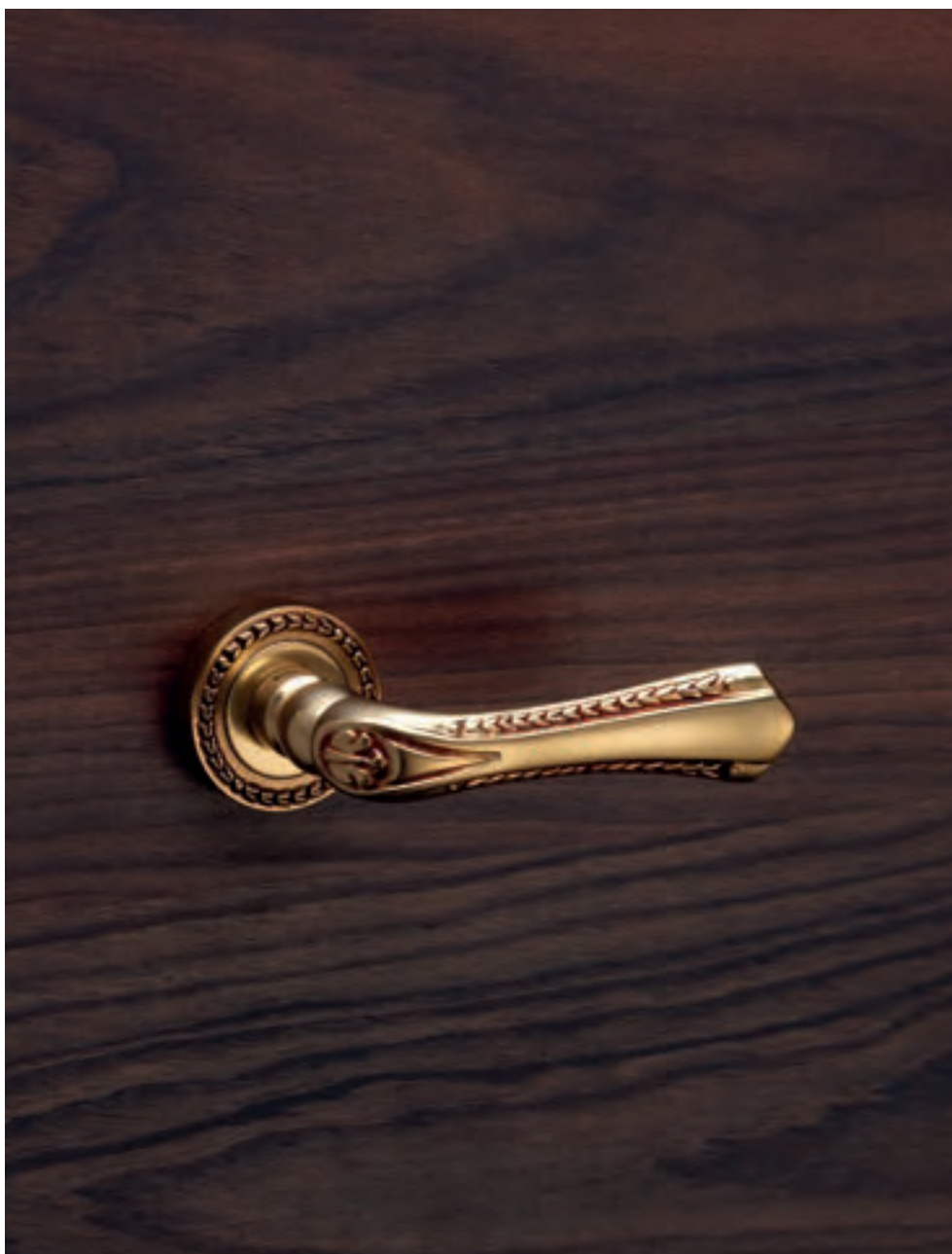

Finiture / Finishes



AA | Argento antico
opaco / *Antique silver*



OF | Oro francese /
French gold



OO | Ottone opaco /
Matt brass



OZ | Oro zecchino /
Gold plated



PM | Patiné / *Patiné
mat*

L'ossessione per il culto della bellezza reinventa il classico e dà forma a una collezione elegante e immortale nella sua semplicità.

An obsession with the cult of beauty reinvents the classics and gives shape to a collection that is elegant and immortal in its simplicity.

Collezione / Collection

1400 RB 009
Maniglia con rosetta
art.009 / Door
handle on rose
art.009

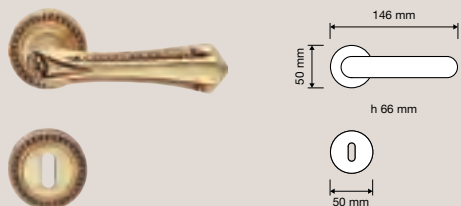

1400 PG 010
Pomolo a girare
con rosetta art.010
/ Turnable knob on
rose art.010

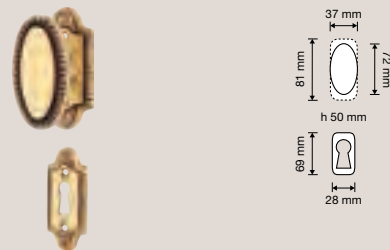

1400 RB 010
Maniglia con rosetta
art.010 / Door handle
on rose art.010

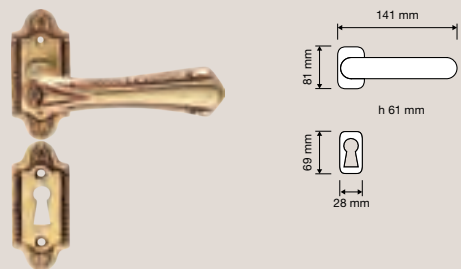

1400 PP
Pomolo a girare con
placca / Turnable
knob on plate

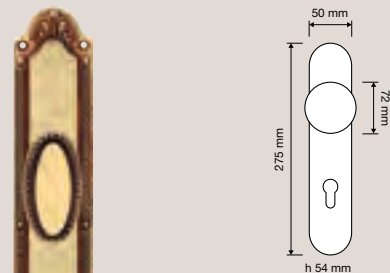

1400 PL
Maniglia con placca /
Door handle on plate

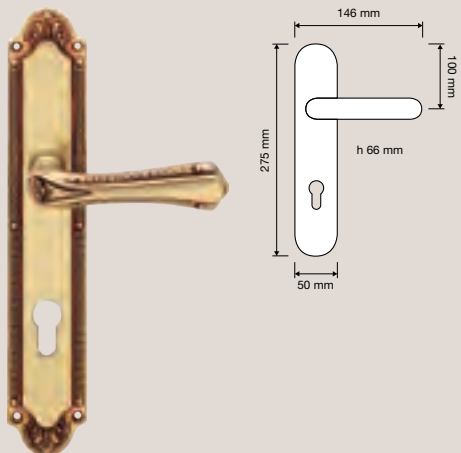

1400 CR
Cremonese /
Window handle gratz

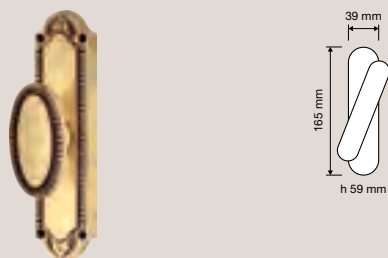

1400 PT
Pomolo a tirare con
rosetta art.010 /
Fixed knob on rose
art.010



Soleil —



La sontuosità e i fasti del Re Sole vengono evocati da raffinatissimi rilievi ornamentali in stile Luigi XIV, ottenuti grazie alla tecnica dell'intarsio del quale ne era maestro l'ebanista francese André-Charles Boulle.

The wealth and magnificence of the Sun King are evoked by refined ornamental embossments in the Louis XIV style, obtained thanks to the inlay technique of which the French cabinet-maker André-Charles Boulle was a master.

Collezione / Collection

Finiture / Finishes



AA | Argento antico
opaco / *Antique silver*



OF | Oro francese /
French gold



OZ | Oro zecchino /
Gold plated



PM | Patiné / *Patiné mat*

1325 RB 015
Maniglia con rosetta
art.015 / *Door handle
on rose art.015*

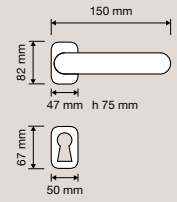

1325 RB 113
Maniglia con rosetta
art.113 / *Door handle
on rose art.113*

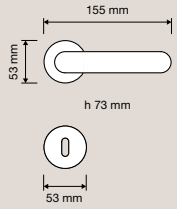

1325 PL
Maniglia con placca /
Door handle on plate

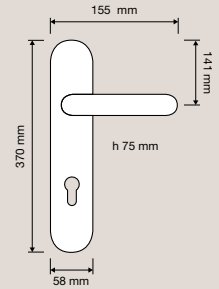

1325 DK
Maniglia per finestra
con movimento DK 4
posizioni / *Window
handle with DK
movement 4 clicks*

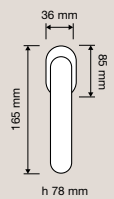

Tiffany —



Finiture / Finishes



OF | Oro francese /
French gold



OZ | Oro zecchino /
Gold plated



PM | Patiné / *Patiné
mat*



TM | Peltro / *Pewter*

Uno stile Tiffany austero, ma non per questo meno dolce e piacevole, caratterizzato da particolari finiture che imprimono alla collezione uno stile autentico.

An austere Tiffany style, but no less sweet and pleasant, characterised by particular finishes that give the collection an authentic style.

Collezione / Collection

1308 RB 018
Maniglia con rosetta
art.018 / Door handle
on rose art.018

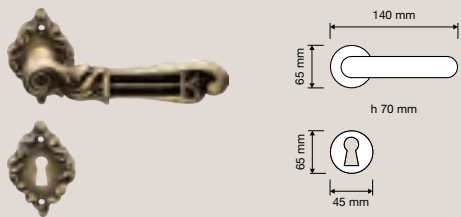

1308 DK
Maniglia per finestra
con movimento DK 4
posizioni / Window
handle with DK
movement 4 clicks



1308 RB 113
Maniglia con rosetta
art.113 / Door handle
on rose art.113

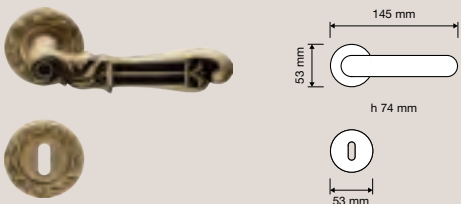

1308 PT
Pomolo a tirare /
Fixed knob



1308 PL
Maniglia con placca /
Door handle on plate

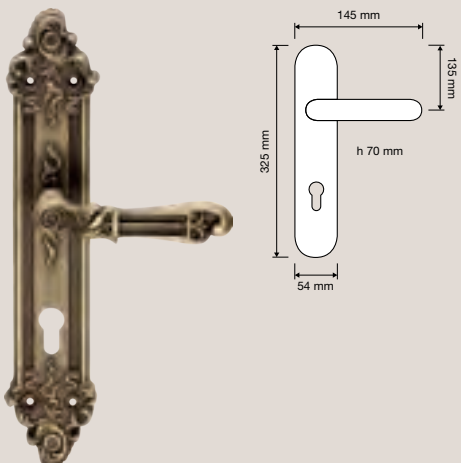

1308 PG 092
Pomolo a girare con
rosetta art.092 /
Turnable knob on
rose art.092



1308 CR
Cremonese /
Window handle gratz



1308 MN 232
Maniglione / Pull
handle

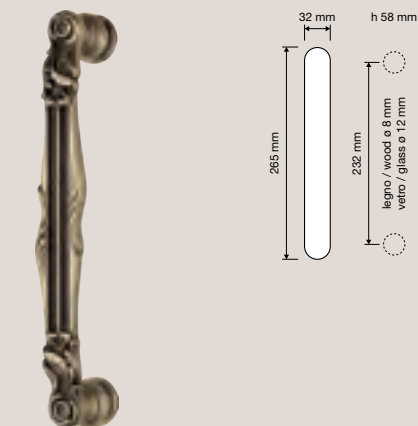

Zaara



Finiture / Finishes



OF | Oro francese /
French gold



OZ | Oro zecchino /
Gold plated



PM | Patiné / Patiné
mat

Il fascino orientale del Taj Mahal è rievocato in questa imponente collezione, omaggio al più grande monumento al mondo fatto erigere per amore.

The oriental fascination of the Taj Mahal is evoked in this impressive collection, a tribute to the greatest monument in the world erected to love.

Collezione / Collection

1535 RB 015
Maniglia con rosetta
art.015 / Door handle
on rose art.015

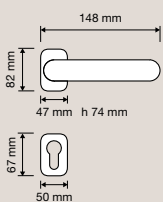

1535 DK
Maniglia per finestra
con movimento DK 4
posizioni / Window
handle with DK
movement 4 clicks

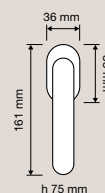

1535 RB 113
Maniglia con rosetta
art.113 / Door handle
on rose art.113

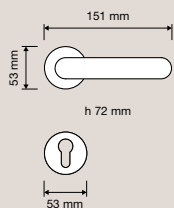

1563 IP
Placca incasso su
placca Small / Flush
pull on plate Small

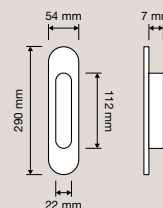

1535 PL
Maniglia con placca
Big / Door handle on
Big plate

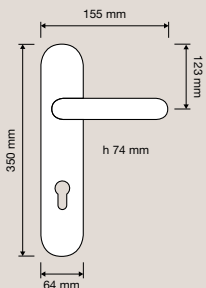

1563 PL
Maniglia con placca
Small art.1563 /
Door handle on plate
Small art.1563

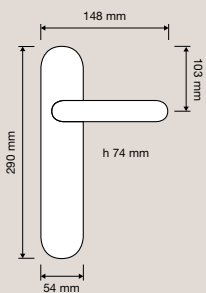

Accessori *Accessories*



Maniglioni contemporanei / *Contemporary pull handles*



Elle Pelle zancato 52



Ibis 72

Pag.



Cavity 42



Era 58



Jenny 74



Elle 50



Grip 64



Kendo 78



Elle zancato 50



Grip Ebano 66



Kendo 78



Elle Pelle 52

















Grip Pelle 68



Kendo zancato 78









Maniglioni classici / *Classic pull handles*

	Open	330		Slim Pelle zancato	104		
	Profilo	92		Spirit	108		Aldar
							Pag. 126
	Slim	102		Thais	112		Creative Classic
							329
	Slim zancato	102		Zen	118		Creative Crown
							329
	Slim Pelle	104		Zen Wengè	122		Dalia
							134

	Delfino	138		Garda	180		Marina	162
	Elika	140		Havana	148		Rose	168
	Erica	142		Karina	152		Tosca	174
	Firenze	146		Lady	158			
	Firenze zancato	146		Margherita	330			

Maniglioni con
Swarovski® /
*Pull handles with
Swarovski®*

Pag.

	Creative Crystal	329		Havana Mesh	212		Ninfa Crystal	228
	Creative Mesh	329		Jewel	216		Opera Crystal	230
	Crystal	196		Jewel	216		Otello Crystal	331
	Elika Crystal	198		King	330		Otello Crystal zancato	331
				Luce	222		Otello Jewel	332



Profilo Mesh 234



Spirit Mesh 248

Maniglioni vintage / *Vintage pull handles*



Queen Crystal 306



Tiffany Mesh 250



Aida 260



Reflex 236



Veronica 252



Arcadia 266



Shell Mesh 242



Zen Mesh 254



Arte 268



Sogno 246



Chic 274



Daisy 276



Jardin 286



Ninfa Porcellana 298



Daisy 276



Liberty 290



Opera 300



Dorothy 330



Liberty 290



Otello 331



Frida 282



Liberty 290



Otello zancato 331



Glamor 284



Ninfa 296



Queen 306



Queen 306



Zayed 332



Rococò 310



Zayed zancato 332



Tiffany 316



Totem 332

Creative Classic 1130
MN 380
 Maniglione. Interassi disponibili 380-550-700. / Pull handle.
 Available distances 380-550-700.

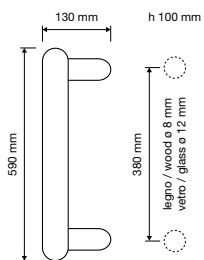

Finiture / Finishes



Creative Crystal 1147
MN 380
 Maniglione. Interassi disponibili 380-550-700. / Pull handle.
 Available distances 380-550-700.

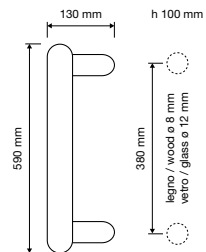

Finiture / Finishes



Creative Crown 1144
MN 380
 Maniglione. Interassi disponibili 380-550-700. / Pull handle.
 Available distances 380-550-700.

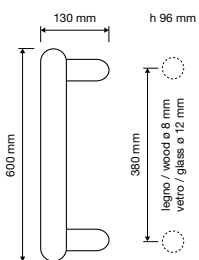

Finiture / Finishes



Creative Mesh 1145
MN 380
 Maniglione. Interassi disponibili 380-550-700. / Pull handle.
 Available distances 380-550-700.

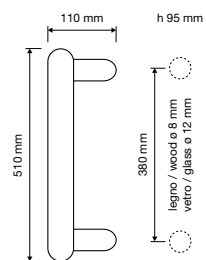

Finiture / Finishes



Dorothy 1710 MN
600
Maniglione. Interassi
disponibili 300-
400-600-800. / Pull
handle. Available
distances 300-400-
600-800.

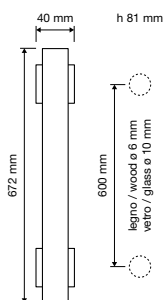

Finiture / Finishes



Margherita 368 MN
240
Maniglione / Pull
handle

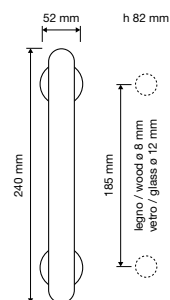

Finiture / Finishes



King 1370 MN 406
Maniglione. Interassi
disponibili 410-583-
897. Attenzione:
l'interasse può
variare leggermente,
chiedere sempre
le misure prima di
forare la porta. / Pull
handle. Available
distances 410-583-
897. Attention: the
distance can have
little changes, please
always ask before
making the holes in
the door.

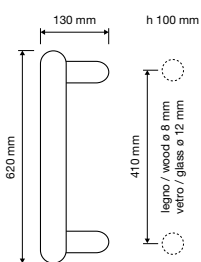

Finiture / Finishes



Open 1105 MN 207
069
Maniglione con
rosette art.069 /
Pull handle on roses
art.069

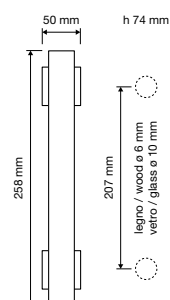

Finiture / Finishes



Otello 1475 MN 400
Maniglione. Interassi
disponibili 400-500-
600. / Pull handle.
Available distances
400-500-600.

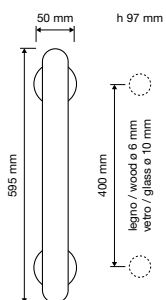

Finiture / Finishes

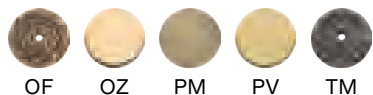

Otello Crystal 1465
MN 400
Maniglione. Interassi
disponibili 400-500-
600. / Pull handle.
Available distances
400-500-600.

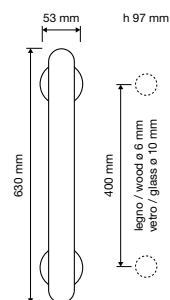

Finiture / Finishes

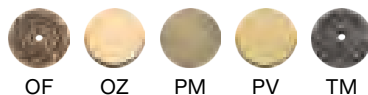

Otello zancato 1475
MZ 400
Maniglione zancato.
Interassi disponibili
400-500-600. /
Offset pull handle.
Available distances
400-500-600.

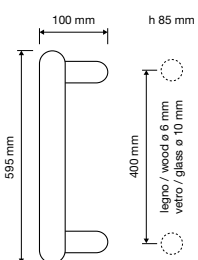

Finiture / Finishes

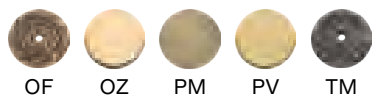

Otello Crystal zancato
1465 MZ 400
Maniglione zancato.
Interassi disponibili
400-500-600. /
Offset pull handle.
Available distances
400-500-600.

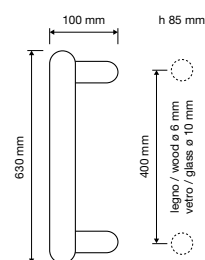

Finiture / Finishes

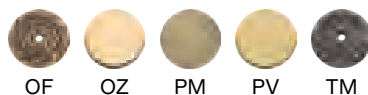

Otello Jewel 1466
MN 400
Maniglione. Interassi
disponibili 400-500-
600. / Pull handle.
Available distances
400-500-600.

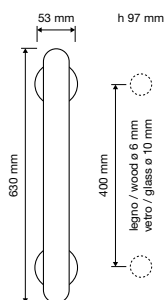

Finiture / Finishes



OZ

Zayed 1721 MN 400
Maniglione. Interassi
disponibili 400-500-
600. / Pull handle.
Available distances
400-500-600.

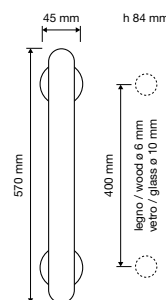

Finiture / Finishes



OZ



PM



PV

Totem 1315 MN 800
Maniglione. Interassi
disponibili 600-800-
900-1200. / Pull
handle. Available
distances 600-800-
900-1200.

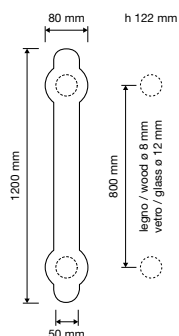

Finiture / Finishes



OF



OZ



PM

Zayed 1721 MZ 400
Maniglione zancato.
Interassi disponibili
400-500-600. /
Offset pull handle.
Available distances
400-500-600.

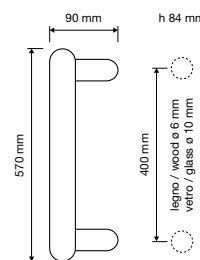

Finiture / Finishes



OZ



PM



PV

Maniglioni alzanti / *Pull-up handles*

Komfort 1617 MN
Maniglione alzante
singolo con nicchia
*/ Single pull handle
with flush pull*

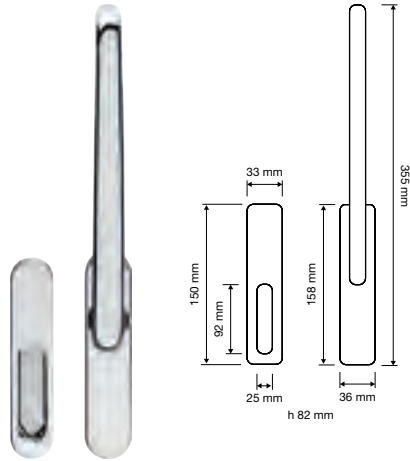

Finiture / Finishes



Komfort 1617 MC
Maniglione alzante
accoppiato foro yale
*/ Set pull handles
cylinder hole*

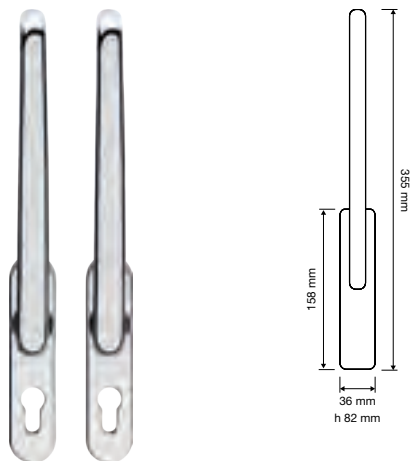

Finiture / Finishes



Zen 1615 MN
Maniglione alzante
singolo con nicchia
*/ Single pull handle
with flush pull*

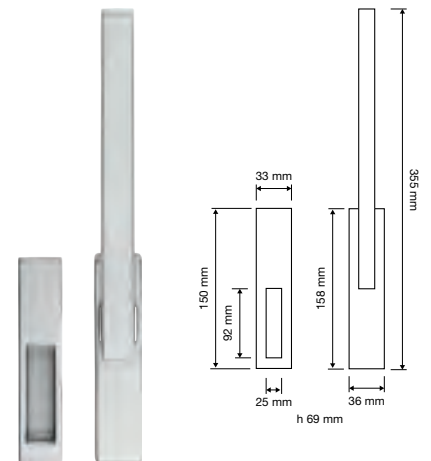

Finiture / Finishes



Zen 1615 MC
Maniglione alzante
accoppiato foro yale
*/ Set pull handles
cylinder hole*

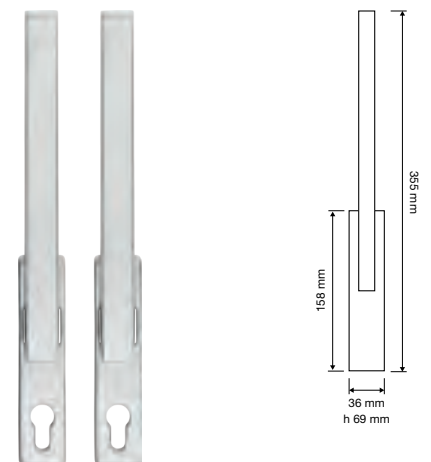

Finiture / Finishes

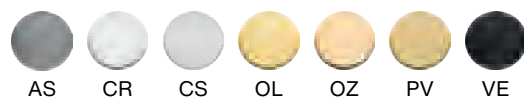

Zen Mesh 1616 MN
Maniglione alzante
singolo con nicchia
*/ Single pull handle
with flush pull*

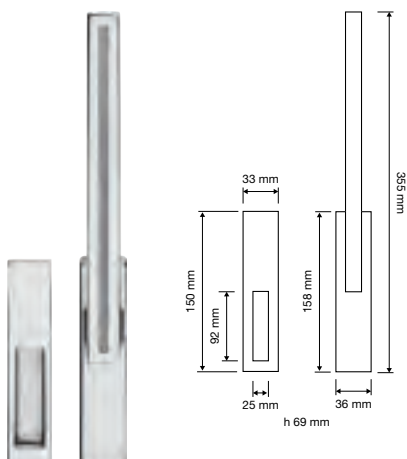

Finiture / *Finishes*



Zen Mesh 1616 MC
Maniglione alzante
accoppiato foro yale
*/ Set pull handles
cylinder hole*

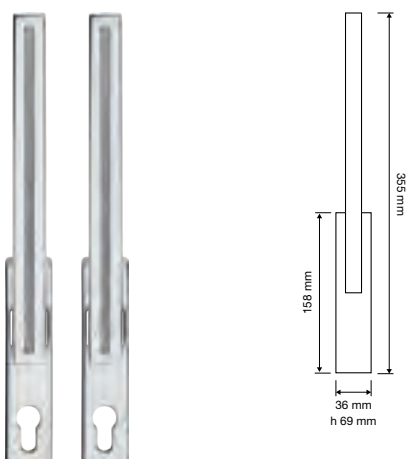

Finiture / *Finishes*



Pomoli per porte / *Door knobs*

Pag.



Open

338



Cuore

338



Delfino

138



Elika

140



Garda

180



Giove

338



Margherita

338



Rose

168



Saba

338



Sfera

339



Sirena

339



Venere

339

Pomoli per porte vintage / *Vintage door knobs*

Pag.



Aisha

262



Ninfa

296



Chic

274



Opera

300



Daisy

276



Queen

306



Epoca

280



Rococò

310



Frida

282



Sissi

312



Glamor

284



Tiffany

316

Pomoli per porte con Swarovski® / *Door knobs with Swarovski®*

Pag.



Crystal

196



Elika Crystal

198



Flory

208



Ninfa Crystal

228



Opera Crystal

230



Reflex

236



Shell Mesh

242



Sogno

246



Tiffany Mesh

250



Veronica

252



Zen Mesh

254

Cuore 416 PT
Pomolo a tirare /
Fixed knob

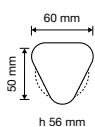

Finiture / Finishes

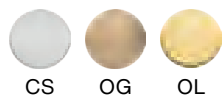

Open 1105 PT 060
Pomolo a tirare /
Fixed knob

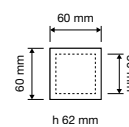

Finiture / Finishes

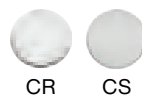

Cuore 416 PG 101
Pomolo a girare
con rosetta art.101
/ Turnable knob on
rose art.101

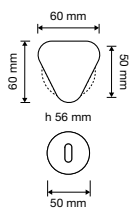

Finiture / Finishes



Open 1105 PG 019
Pomolo a girare
con rosetta art.019
/ Turnable knob on
rose art.019

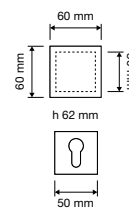

Finiture / Finishes

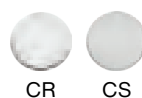

Giove 637 PT 070
Pomolo a tirare /
Fixed knob

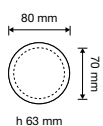

Finiture / Finishes



Saba 441 PT 060
Pomolo a tirare /
Fixed knob

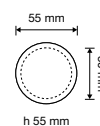

Finiture / Finishes



Margherita 430 PT
070
Pomolo a tirare /
Fixed knob

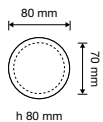

Finiture / Finishes



Saba 441 PG 101
Pomolo a girare
con rosetta art.101
/ Turnable knob on
rose art.101

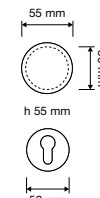

Finiture / Finishes



Saba 441 PG 102
Pomolo a girare
con rosetta art.102
*/ Turnable knob on
rose art.102*

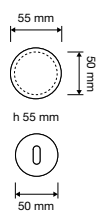

Finiture / Finishes



Sfera 735 PG 102
Pomolo a girare
con rosetta art.102
*/ Turnable knob on
rose art.102*

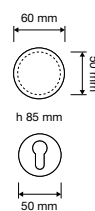

Finiture / Finishes



Saba 401 PT 070
Pomolo a tirare con
rosetta incorporata /
Fixed knob

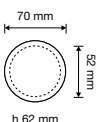

Finiture / Finishes

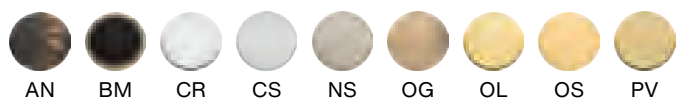

Sirena 810 PT 060
Pomolo a tirare /
Fixed knob

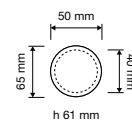

Finiture / Finishes



Sfera 735 PT 060
Pomolo a tirare /
Fixed knob

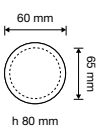

Finiture / Finishes

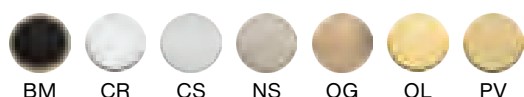

Sirena 810 PG 103
Pomolo a girare
con rosetta art.103
*/ Turnable knob on
rose art.103*

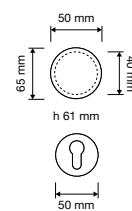

Finiture / Finishes



Sfera 735 PG 101
Pomolo a girare
con rosetta art.101
*/ Turnable knob on
rose art.101*

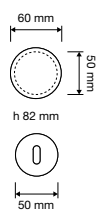

Finiture / Finishes



Venere 410 PT 070
Pomolo a tirare /
Fixed knob

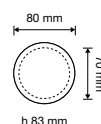

Finiture / Finishes

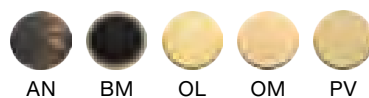

Battenti / Door knockers

Futura 970 BA
Battente / Door
knocker

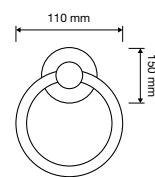

America 359 BA 135
Battente / Door
knocker

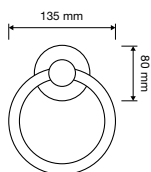

Leone 351 BA 110
Battente con anello
/ Door knocker with
ring

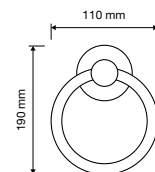

Anello 357 BA 110
Battente / Door
knocker

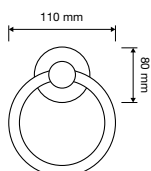

Leone 358 BA 180
Battente / Door
knocker

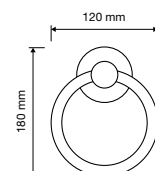

Barocco 355 BA 120
Battente / Door
knocker

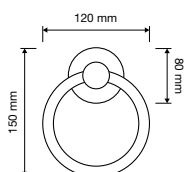

Liberty 1160 BA
Battente / Door
knocker

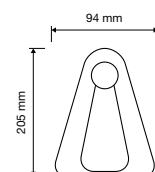

Elika 990 BA
Battente / Door
knocker

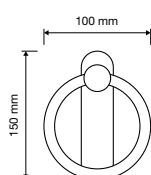

Margherita 369 BA
120
Battente / Door
knocker

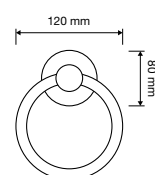

Elika Crystal 991 BA
Battente / Door
knocker

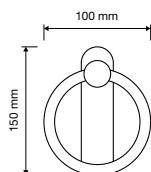

Rose 996 BA
Battente / Door
knocker

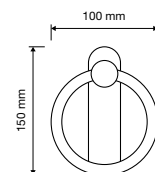

Bocchette / Escutcheons

004 BO 0053
Bocchetta mm 53 /
Escutcheon mm 53



010 BO 0081
Bocchetta sagomata,
disponibile
esclusivamente
con foro yale.
/ Escutcheon,
available only with
cylinder hole.

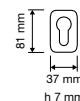

011 BO 0050
Bocchetta tonda
mm 50 / Round
escutcheon mm 50

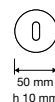

005 BO 0071
Bocchetta sagomata
mm 71 / Escutcheon
mm 71

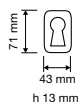

015 BO 0068
Bocchetta sagomata
mm 67 / Escutcheon
mm 67

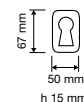

007 BO 0050
Bocchetta quadrata
mm 52 / Square
Escutcheon mm 52

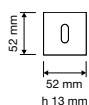

016 BO 0053
Bocchetta mm 53 /
Escutcheon mm 53

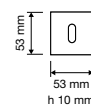

009 BO 0050
Bocchetta tonda
mm 50 / Round
escutcheon mm 50

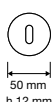

018 BO 0065
Bocchetta sagomata
mm 65 / Escutcheon
mm 65

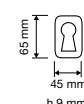

010 BO 0069
Bocchetta sagomata,
disponibile
esclusivamente
con foro chiave.
/ Escutcheon,
available only with
key hole.

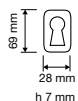

019 BO 0050
Bocchetta quadrata
mm 50 / Square
escutcheon mm 50

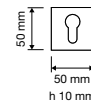

021 BO 0000
Bocchetta
rettangolare
/ *Rectangular
escutcheon*

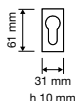

088 BO 0050
Bocchetta quadrata
lamiera mm 50 /
*Square escutcheon
mm 50*

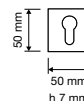

023 BO 0052
Bocchetta tonda
mm 52 / *Round
escutcheon mm 52*

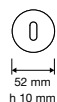

091 BO 0068
Bocchetta sagomata
mm 68 / *Escutcheon
mm 68*

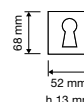

024 BO 0050
Bocchetta quadrata
ribassata mm 50
/ *Reduced square
escutcheon mm 50*

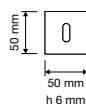

096 BO 0000
Bocchetta ovale /
Oval escutcheon

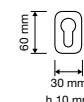

025 BO 0052
Bocchetta tonda
ribassata mm 50
/ *Reduced round
escutcheon mm 50*



101 BO 0045
Bocchetta tonda
coprivite leggera /
Round escutcheon



027 BO 0050
Bocchetta tonda
coprivite leggera
mm 50 foro chiave /
*Round escutcheon
mm 50 key hole*

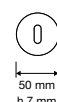

101 BO 0050
Bocchetta tonda
coprivite leggera /
Round escutcheon



078 BO 0072
Bocchetta sagomata
mm 73 / *Escutcheon
mm 73*

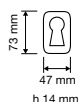

102 BO 0050
Bocchetta tonda
coprivite piana mm
50 / *Round Flat
escutcheon mm 50*



103 BO 0050
Bocchetta tonda
coprivite bombata
mm 50 / *Round
Convex escutcheon
mm 50*

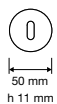

114 BO 0060
Bocchetta quadrata
mm 60 / *Square
escutcheon mm 60*



108 BO 0054
Bocchetta tonda
coprivite mm 54 /
*Round escutcheon
mm 54*



115 BO 0056
Bocchetta tonda
mm 55 / *Round
escutcheon mm 55*



109 BO 0045
Bocchetta tonda viti
vista lamiera / *Round
escutcheon with
visible fixing screws*

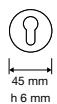

110 BO 0045
Bocchetta tonda viti
vista tornita mm 45
foro chiave / *Round
escutcheon mm 45
with visible fixing
screws key hole*



112 BO 0054
Bocchetta tonda
mm 54 / *Round
escutcheon mm 54*



113 BO 0056
Bocchetta tonda
mm 53 / *Round
escutcheon mm 53*

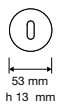

Bocchette set-wc / *Privacy set*

004 SW 0053
Set wc con rosette
tonde / *Privacy set*
on roses



010 SW 0081
Set wc con rosette
sagomate / *Privacy*
set on roses



005 CV 0071
Set wc con rosette
sagomate / *Privacy*
set on roses



011 SW 0050
Set wc con rosette
tonde / *Privacy set*
on round roses



007 CV 0052
Set wc con rosette
quadre / *Privacy set*
on square roses



015 CV 0068
Set wc con rosette
sagomate / *Privacy*
set on roses



008 CV 0073
Set wc con rosette
sagomate / *Privacy*
set on roses



016 SW 0053
Set wc con rosette
quadre / *Privacy set*
on roses



009 SW 0050
Set wc con rosette
tonde / *Privacy set*
on round roses



018 CV 0065
Set wc con rosette
sagomate / *Privacy*
set on roses



019 CV 0050
Set wc Vintage
con rosette quadre
mm50 / *Vintage*
privacy set on square
roses mm50



019 SW 0050
Set wc con rosette
quadre / *Privacy set
on square roses*



078 CV 0050
Set wc con rosette
sagomate / *Privacy
set on roses*



023 SW 0052
Set wc con rosette
tonde / *Privacy set
on round roses*



088 SW 0050 Q
Set wc con rosette
quadre / *Privacy set
on square roses*



024 CV 0050
Set wc Vintage
con rosette quadre
ribassate mm 50 /
*Vintage privacy set
on reduced square
roses mm 50*



091 CV 0068
Set wc con rosette
sagomate / *Privacy
set on roses*



024 SW 0050 Q
Set wc con rosette
quadre ribassate
mm 50 / *Privacy set
on reduced square
roses mm 50*



096 SW
Set wc con rosette
ovali / *Privacy set on
oval roses*



025 SW 0052
Set wc con rosette
tonde ribassate
/ *Privacy set on
reduced round roses*



101 SW 0045
Set wc con rosette
tonde coprivite
leggere / *Privacy set
on round roses*



027 SW 0050 N
Set wc con rosette
tonde coprivite
leggere / *Privacy set
on round roses*



102 SW 0050
Set wc con rosette
tonde piane / *Privacy
set on round flat
roses*



103 SW 0050
Set wc con rosette
tonde bombate /
*Privacy set on round
convex roses*



113 CV 0053
Set wc con rosette
tonde / *Privacy set
on round roses*



108 SW 0054
Set wc con rosette
tonde coprivite /
*Privacy set on round
roses*



114 SW 0060
Set wc con rosette
quadre / *Privacy set
on square roses*



109 SW 0045
Set wc con rosette
tonde viti vista
lamiera / *Privacy set
on round roses with
visible screws*



115 CV 0056
Set wc con rosette
tonde / *Privacy set
on round roses*



110 SW 0045
Set wc con rosette
tonde viti vista
sagomate / *Privacy
set on round roses
with visible screws*



117 NT
Set wc oliva senza
rosette / *Small
Privacy set without
roses*

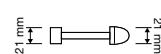

112 CV 0054
Set wc Vintage
con rosette tonde /
*Vintage privacy set
on round roses*



225 NT
Set wc Vintage senza
rosette / *Vintage
Privacy set without
roses*

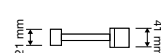

112 SW 0054
Set wc con rosette
tonde / *Privacy set
on round roses*



233 NT
Set wc quadro senza
rosette / *Square
Privacy set without
roses*

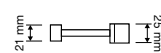

261 NT
Set wc limitatore
senza rosette /
*Limiting Privacy set
without roses*

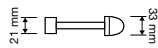

Chiavi / Keys

Delfino 542 CH
Chiave / Door key

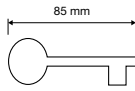

Elena 624 CH
Chiave / Door key

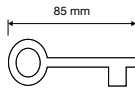

Elle 1050 CH
Chiave / Door key

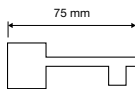

Liberty 1160 CH
Chiave / Door key

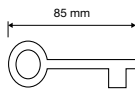

Rose 543 CH
Chiave / Door key

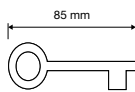

Sirena 818 CH
Chiave / Door key

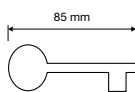

Campanelli / Bells

Campanello 103 CP
Rosetta art.103 con
campanello / Rose
art.103 with bell push

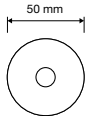

Campanello 139 CP
Rosetta ovale export
con campanello /
Oval export rose with
bell push

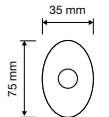

Leone 352 CP
Campanello / Bell

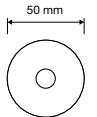

Liberty 1160 CP
Rosetta art.092 con
campanello / Rose
art.092 with bell
push



Fermaporta / Door stops

211 FE
Fermaporta
chiocciola / Door
stop igloo



212 FE
Fermaporta cilindrico
/ Cylindrical door
stop

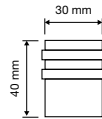

214 FE
Prolunga per
fermaporta /
Extension for door
stop

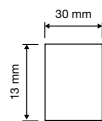

222 FE
Fermaporta cilindrico
con cristallo /
Cylindrical door stop
with crystal

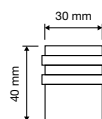

Kono 613 FE
Fermaporta / Door
stop



Vintage 1272 FE
Fermaporta / Door
stop



Zen 301 FE
Fermaporta / Door
stop

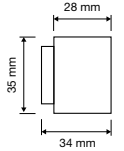

Zen Mesh 302 FE
Fermaporta / Door
stop

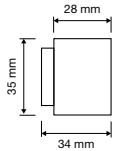

Fermaporta magnetici / Magnetic door stops

1575 FE
Fermaporta
magnetico tondo
/ Round magnetic
door stop

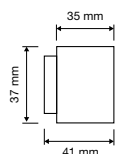

1576 FE
Fermaporta
magnetico crystal
tondo / Round
crystal magnetic
door stop

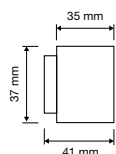

1580 FE 0053
Fermaporta
magnetico tondo
Fancy / Round Fancy
magnetic door stop

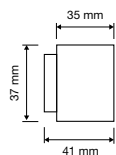

Swarovski®

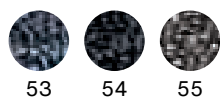

Zen 1577 FE
Fermaporta
magnetico quadro
/ Square magnetic
door stop

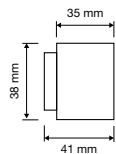

Zen Mesh 1578 FE
Fermaporta
magnetico quadro
/ Square magnetic
door stop

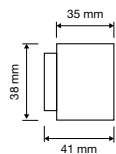

Appendiabiti / Coat hooks

Diamante 905 AB
Appendiabiti / Coat
hook

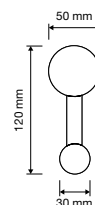

910 AB
Appendiabiti / Coat
hook

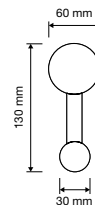

Liberty 1160 AB
Appendiabiti / Coat
hook

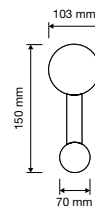

Reflex 1215 AB
Appendiabiti / Coat
hook

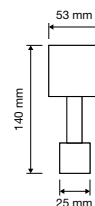

Zen 1156 AB
Appendiabiti / Coat
hook

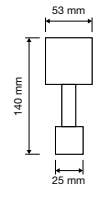

Zen Mesh 1157 AB
Appendiabiti / Coat
hook

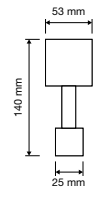

Maniglie e accessori per porte blindate / *Handles and accessories for armored doors*

Giove 259 B3
Pomolo fisso con
bloccapomolo /
*Single fixed knob
with turnlock base*

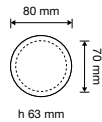

Sfera 260 B3
Pomolo fisso con
rosetta art.101 e
bloccapomolo /
*Single fixed knob
with rose art.101 and
turnlock base*

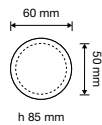

Garda 400 PT 065
Pomolo a tirare con
rosetta incorporata /
Fixed knob

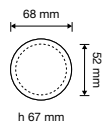

Saba 401 PT 070
Pomolo a tirare con
rosetta incorporata /
Fixed knob

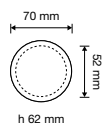
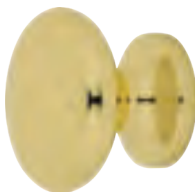

255 B2
Garda + pomolo fisso
Saba con rosetta
art.101 + nipples /
*Garda + fixed knob
Saba on rose art.101
+ nipples spindle*

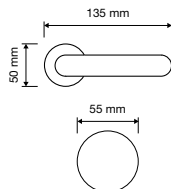

258 B2
Garda + pomolo fisso
Sfera con rosetta
art.101 + nipples /
*Garda + fixed knob
Sfera on rose art.101
+ nipples spindle*

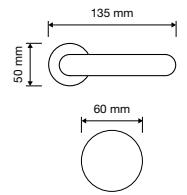

252 B1
Garda con rosetta
art.101 + ferro
espansione / *Garda
on rose art.101 +
expansion spindle*

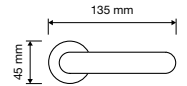

293 B4
Limitatore quadro
30x33,5 con rosetta
art.019 / *Square
limiting device
30x33,5 on rose
art.019*



294 B4
Limitatore quadro
30x33,5 con rosetta
art.102 / *Square
limiting device
30x33,5 on rose
art.102*



249 B4
Limitatore tondo
scorrevole a slitta
/ *Rounded sliding
limiting device*



262 B4
Limitatore con
rosetta art.101 /
*Limiting device on
rose art.101*



261 B4
Limitatore con
rosetta ovale /
Limiting device on
oval rose



268 B5 0082 000D
Rosone mm 62x82
per blindate foro
doppia mappa /
Rose mm 62x82 for
main entrance doors
double map hole



264 B5
Bocchetta doppia
mappa art.101
per porta blindata
/ Double map
Escutcheon art.101 for
main entrance door



268 B5 0082 FM11
Rosone mm 62x82
per blindate / Rose
mm 62x82 for main
entrance doors



297 B5
Bocchetta doppia
mappa art.019
per porta blindata
/ Double map
Escutcheon art.019
for main entrance
door



268 B5 0082 SLIT
Rosone mm 62x82
per blindate x
limitatore apertura
a slitta / Rose mm
62x82 for main
entrance doors
sliding opening



298 B5
Rosetta art.019 foro
12 spostato per
porta blindata / Rose
art.019 hole 12 for
main entrance door



268 B5 0082 FM16
Rosone mm 62x82
per blindate / Rose
mm 62x82 for main
entrance doors



300 B4
Nottolino quadro
25x24,5 foro 8 con
rosetta art.019, foro
12 spostato / Square
limiting device 25x24,5
hole 8 on rose art.019
with hole 12

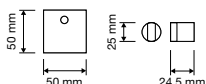

268 B7
Copridefender con
cover / Cover for
defender



268 B5 0082 000Y
Rosone mm 62x82
per blindate foro yale
/ Rose mm 62x82 for
main entrance doors
cylinder hole



150 B6
Nottolino Vintage per
cilindro con codulo
foro 8 / Vintage
limiting device only
hole 8

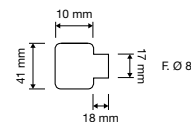

236 B6
Nottolino quadro
30x30 foro 8 per
cilindro / *Square
limiting device only
30x30 hole 8*

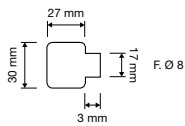

237 B6
Nottolino quadro
30x39 foro 10 per
cilindro / *Square
limiting device only
30x39 hole 10*

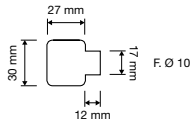

267 B6
Nottolino per cilindro
con codulo foro 8 /
*Limiting device only
hole 8*

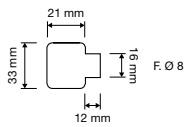

295 B6
Nottolino quadro
25x24,5 foro 8 per
cilindro / *Square
limiting device only
25x24,5 hole 8*

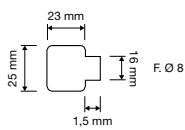

Placche incasso / *Flush pull*

Anna 849 PI
Placca incasso /
Flush pull

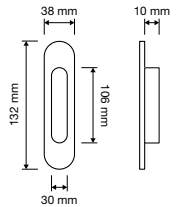

Liberty 1160 PI
Placca incasso /
Flush pull

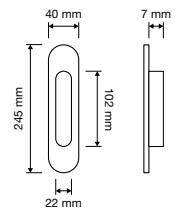

179 PI
Placca incasso
coprivite lamiera
fondo plastica mm
125x39 / *Flush pull
with nylon back mm
125x39*

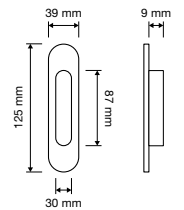

189 PI
Placca incasso
quadra mm
60x60x12 / *Square
flush pull mm
60x60x12*



168 PI
Maniglia di
trascinamento tonda
decentrata mm 29
/ *Round finger pull
mm 29*



169 PI
Placca incasso tonda
mm 57x12 / *Round
flush pull mm 57x12*



Vintage 1277 PI
Placca incasso /
Flush pull

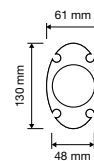

190 PI
Maniglia di
trascinamento
quadra decentrata
mm 27 / *Square
finger pull mm 27*



Placche incasso su placca / *Flush pull on plate*

Profilo 1042 PI
Placca incasso /
Flush pull

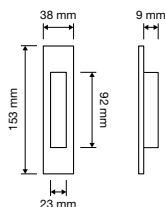

Aida 1611 IP
Placca incasso su
placca Small / *Flush
pull on plate Small*

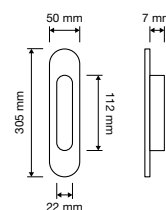

Profilo Mesh 1043 PI
Placca incasso /
Flush pull

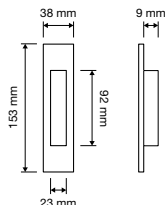

Aisha 1650 IP
Placca incasso su
placca Small / *Flush
pull on plate Small*

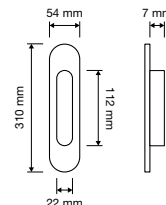

Saba 629 PI
Placca incasso /
Flush pull

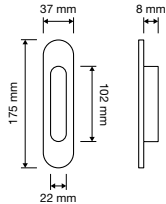

Beta 488 IP
Placca incasso su
placca / *Flush pull on
plate*

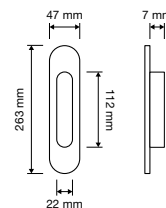

Sirena 819 PI
Placca incasso /
Flush pull

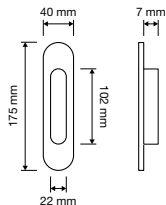

Chic 1670 IP
Placca incasso su
placca / *Flush pull on
plate*

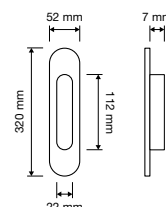

Glamor 1555 IP
Placca incasso su
placca / *Flush pull on
plate*

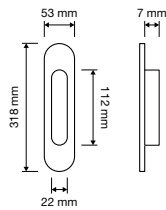

Jardin 1562 IP
Placca incasso su
placca Small / *Flush
pull on plate Small*

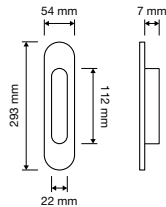

Lady 1390 IP
Placca incasso su
placca / *Flush pull on
plate*

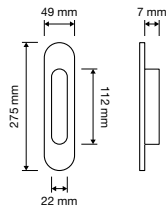

Saba 625 IP
Placca incasso su
placca / *Flush pull on
plate*

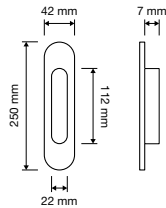

Vola 750 IP
Placca incasso su
placca / *Flush pull on
plate*

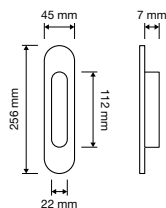

Zaara 1563 IP
Placca incasso su
placca Small / *Flush
pull on plate Small*

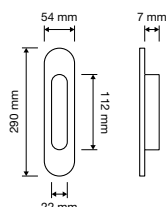

Kit incasso / *Inset handle kit*

184 KT
Kit incasso quadrato
con nottolino, taglio
cacciavite, maniglia
trascinamento e
serratura / *Square
inset handle kit with
thumb, finger pull
and locking system*

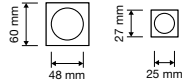
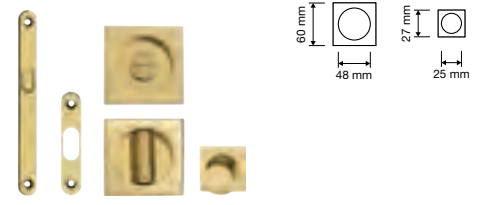

186 KT
Kit incasso
quadrato foro
chiave con maniglia
trascinamento,
serratura e chiave /
*Square inset handle
kit key hole with
finger pull, locking
system and key*

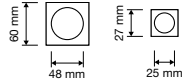

331 KT
Kit incasso tondo
con nottolino, taglio
cacciavite, maniglia
trascinamento e
serratura / *Round
inset handle kit with
thumb, finger pull
and locking system*

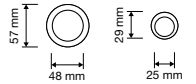

332 KT
Kit incasso tondo
foro chiave
con maniglia
trascinamento,
serratura e chiave /
*Round inset handle
kit key hole with
finger pull, locking
system and key*

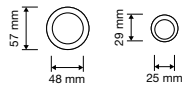

Vintage 1274 KT
Kit incasso con
placche piene
e maniglia
trascinamento / *Inset
handle blind hole kit
with finger pull*

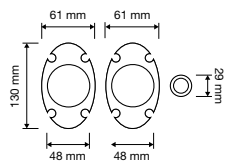
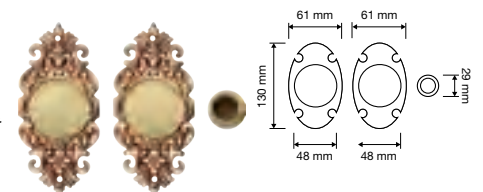

Vintage 1275 KT
Kit incasso foro
chiave con maniglia
trascinamento / *Inset
handle key hole kit
with finger pull*

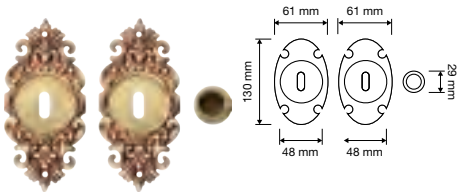

Vintage 1276 KT
Kit incasso con
nottolino, taglio
cacciavite e maniglia
trascinamento / *Inset
handle kit with
thumb and finger pull*

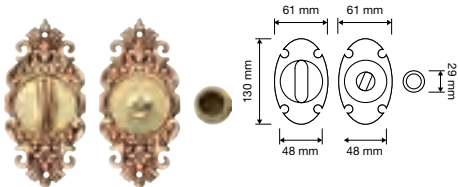

510 KD/KS
Corner (dx o sx)
+pomolo fisso con
placca art.1104 / *Corner
(right or
left)+fixed knob on
plate art.1104*

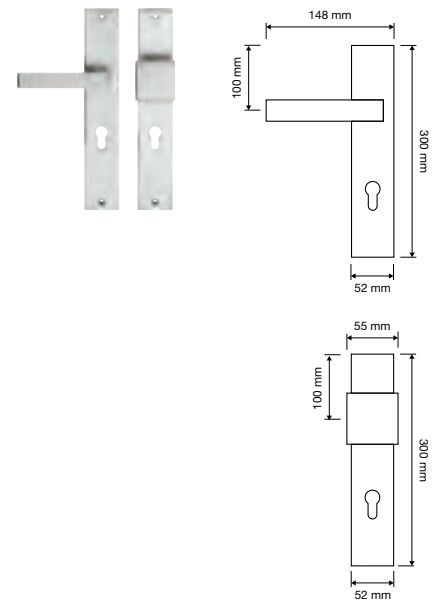

Serie Hotel / *Hotel series*

505 DH/SH 019 0Y
Corner (dx o sx)
+pomolo fisso con
rosetta e bocchetta
yale art.019 / *Corner
(right or left)+fixed
knob on rose and
cylinder escutcheon
art.019*

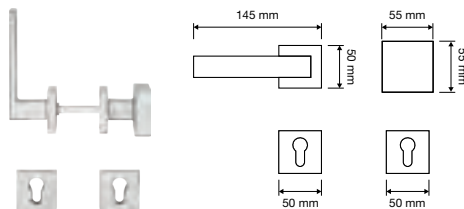

505 RW 019
Corner con rosetta
art.019 c/set wc
/ *Corner on rose
art.019 w/privacy set*

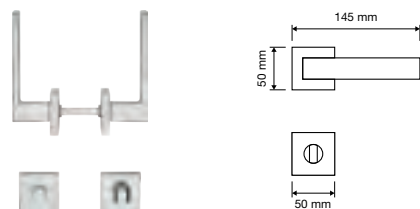

510 PW
Corner con placca
art.1104 c/set wc
/ *Corner on plate
art.1104 with privacy
set*

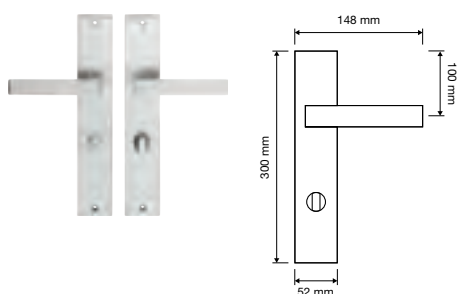

617 DH/SH 102 0Y
Samoa (dx o sx)
+pomolo fisso
Sfera con rosetta
e bocchetta yale
art.102 / *Samoa
(right or left)+fixed
knob Sfera on
rose and cylinder
escutcheon art.102*

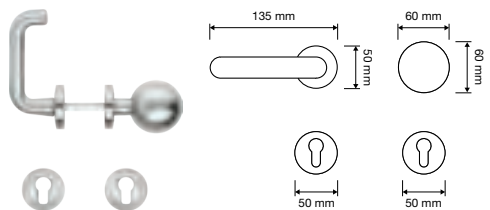

620 RW 102
Samoa con rosetta
art.102 c/set wc
/ *Samoa on rose
art.102 w/privacy set*

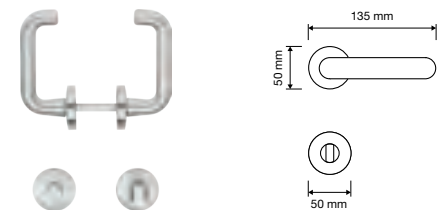

622 PW
Samoa con placca
art.1595 c/set wc
/ *Samoa on plate
art.1595 with privacy
set*

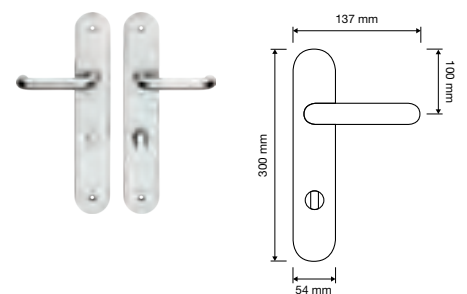

622 KD/KS
 Samoa (dx o sx)
 +pomolo fisso
 Sfera con placca
 art.1595 / Samoa
 (right or left)+fixed
 knob Sfera on plate
 art.1595

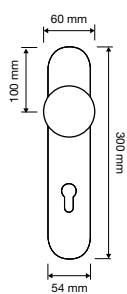
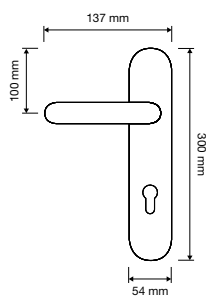

617 KD/KS
 Samoa (dx o sx)
 +pomolo fisso Sfera
 con placca art.123
 / Samoa (right or
 left)+fixed knob
 Sfera on plate art.123

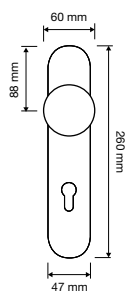
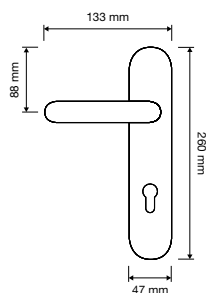

617 PW
 Samoa con placca
 art.123 c/set wc
 / Samoa on plate
 art.123 with privacy
 set

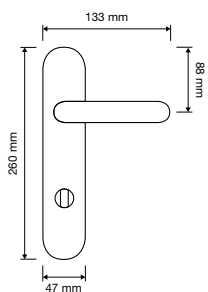

Copricerniere / Hinge covers

240 CI
 Copricerniera liscio /
 Flat Hinge cap

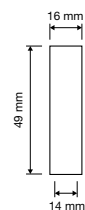

241 CI
 Copricerniera liscio /
 Flat Hinge cap

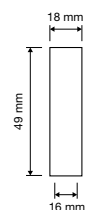

242 CI
 Copricerniera liscio /
 Flat Hinge cap



245 CI
 Copricerniera a
 piramide / Cone
 Hinge cap

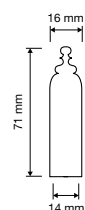

246 CI
 Copricerniera a
 piramide / Cone
 Hinge cap

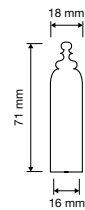

247 CI
Copricerniera a
piramide / *Cone*
Hinge cap

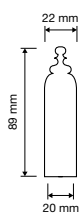

1571 CI 1664
Copricerniera Mesh /
Mesh Hinge cap

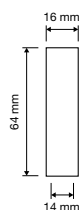

1571 CI 1864
Copricerniera Mesh /
Mesh Hinge cap



1571 CI 2281
Copricerniera Mesh /
Mesh Hinge cap

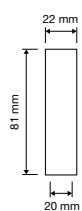

Vintage 1273 CI 1772
Copricerniera /
Hinge cap

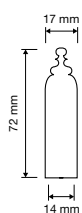

Vintage 1273 CI 1972
Copricerniera /
Hinge cap

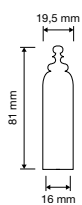

Cerniere / *Hinges*

Vintage 1270 CE
Cerniera / *Hinge*

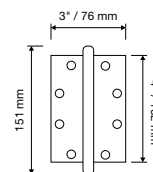

Vintage 1271 CE
Cerniera / *Hinge*

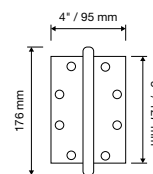

Materiale pubblicitario / Advertising material

ADR 046
Adesivo prespaziato
argento / Silver pre-
spaced adhesive

lineacalì

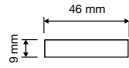

062 AC 00
LINEACALI
Espositore girevole
bifacciale da
pavimento con 4
pannelli / *Revolving
floor display with 4
panels*

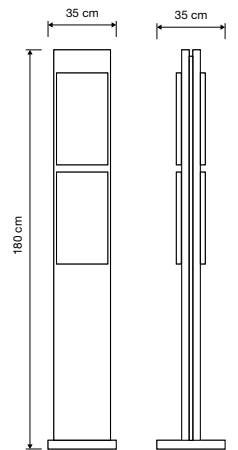

ADQ 140
Vetrofania / *Window
sticker*

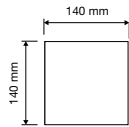

064 AC 00
LINEACALI
Espositore da parete
/ *Wall display*

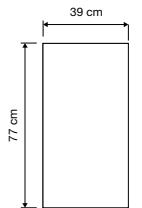

ADR 370
Adesivo prespaziato
argento / Silver pre-
spaced adhesive

lineacalì



065 AC 00
LINEACALI
Espositore girevole
da pavimento con 12
pannelli / *Revolving
floor display with 12
panels*

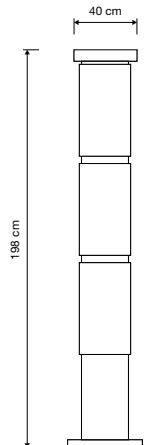

066 AC 00
LINEACALI
Espositore da parete
con 6 pannelli / *Wall
display with 6 panels*

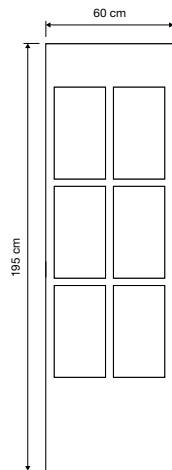

CATA00 FINITURE
Cartella finiture
colori / *Color finishes
chart*



071 AC
Espositore da
banco SmartBlock
/ *SmartBlock desk
display*

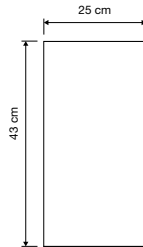

074 AC 00
LINEACALI
Espositore girevole
da banco con 2
pannelli / *Revolving
desk display with 2
panels*

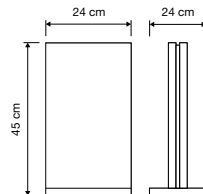
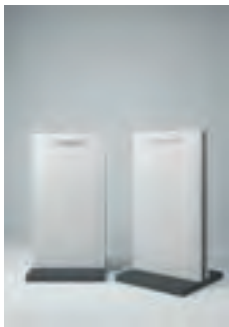





Accessori per mobili *Cabinet accessories*

Pomelli per mobili / *Cabinet knobs*

Cometa 324 PB
0000
Pomolo per
mobile con cristalli
Swarovski® /
*Cabinet knob with
Swarovski® crystals*

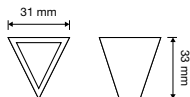
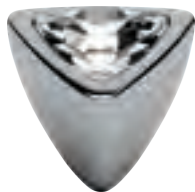

Finiture / *Finishes*



Cosmic 209 PB
0022
Pomolo per
mobile con cristalli
Swarovski® /
*Cabinet knob with
Swarovski® crystals*

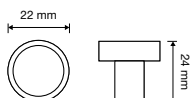

Finiture / *Finishes*



Cosmic 209 PB
0030
Pomolo per
mobile con cristalli
Swarovski® /
*Cabinet knob with
Swarovski® crystals*

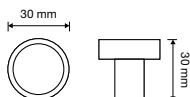

Finiture / *Finishes*



Crystal 200 PB 0020
Pomolo per
mobile con cristalli
Swarovski® /
*Cabinet knob with
Swarovski® crystals*

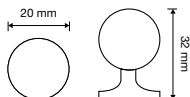

Finiture / *Finishes*



Crystal 200 PB 0030
Pomolo per
mobile con cristalli
Swarovski® /
*Cabinet knob with
Swarovski® crystals*

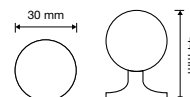

Finiture / *Finishes*



Crystal 200 PB 0040
Pomolo per
mobile con cristalli
Swarovski® /
*Cabinet knob with
Swarovski® crystals*

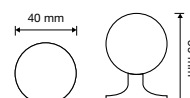

Finiture / *Finishes*



Diamante 206 PB
0024
Pomolo per
mobile con cristalli
Swarovski® /
*Cabinet knob with
Swarovski® crystals*

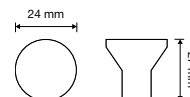

Finiture / *Finishes*

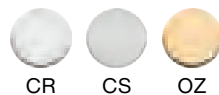

Elika Crystal 991 PB
0026
Pomolo per
mobile con cristalli
Swarovski® /
*Cabinet knob with
Swarovski® crystals*

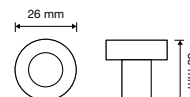

Finiture / *Finishes*



Elika Crystal 991 PB 0035
 Pomolo per mobile con cristalli Swarovski® / Cabinet knob with Swarovski® crystals

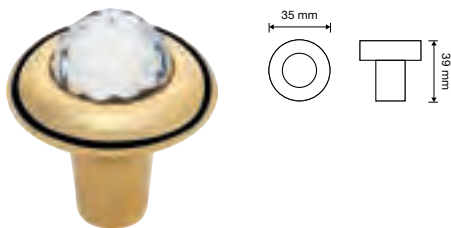

Finiture / Finishes



Mesh 203 PB 0024
 Pomolo per mobile con cristalli Swarovski® / Cabinet knob with Swarovski® crystals

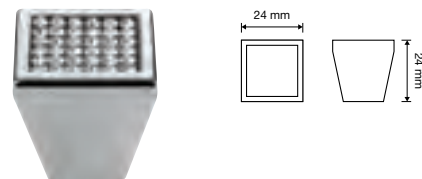

Finiture / Finishes



Elios Crystal 323 PB 0000
 Pomolo per mobile con cristalli Swarovski® / Cabinet knob with Swarovski® crystals

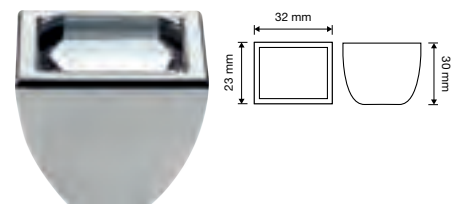

Finiture / Finishes



Swarovski®

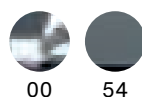

Mesh 203 PB 0030
 Pomolo per mobile con cristalli Swarovski® / Cabinet knob with Swarovski® crystals

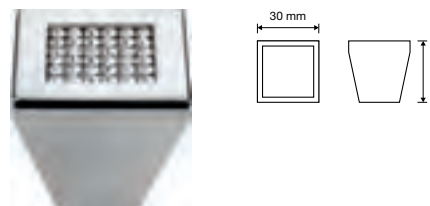

Finiture / Finishes



Elipse 322 PB 0000
 Pomolo per mobile con cristalli Swarovski® / Cabinet knob with Swarovski® crystals

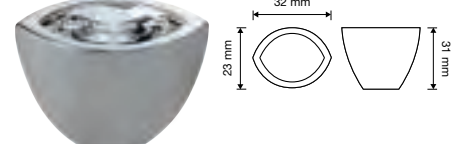

Finiture / Finishes

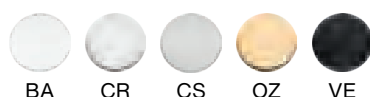

Mirror 204 PB 0030
 Pomolo per mobile con cristalli Swarovski® / Cabinet knob with Swarovski® crystals

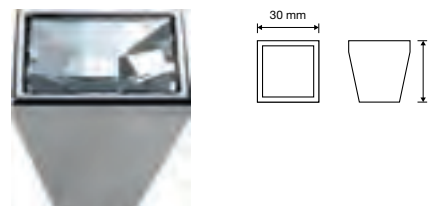

Finiture / Finishes



Fancy 210 PB 0034
 Pomolo per mobile con cristalli Swarovski® / Cabinet knob with Swarovski® crystals

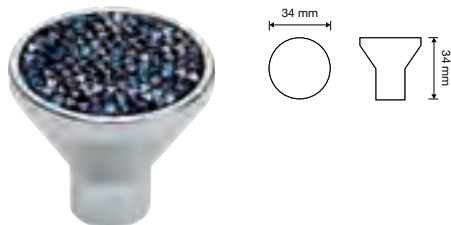

Finiture / Finishes

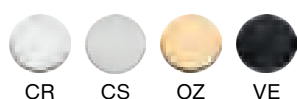

Swarovski®

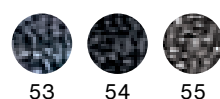

Pop-Art 205 PB 0030
 Pomolo per mobile con cristalli Swarovski® / Cabinet knob with Swarovski® crystals

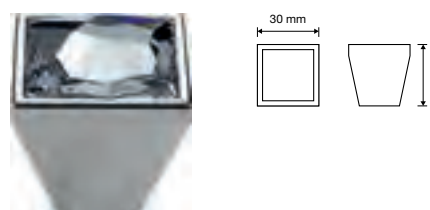

Finiture / Finishes



Reflex 321 PB 0024
Pomolo per
mobile con cristalli
Swarovski® /
Cabinet knob with
Swarovski® crystals

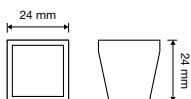

Finiture / Finishes



Swarovski®

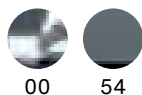

Rocks 224 PB 0030
Pomolo per
mobile con cristalli
Swarovski® /
Cabinet knob with
Swarovski® crystals

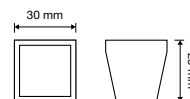

Finiture / Finishes



Swarovski®



Ring 320 PB 0024
Pomolo per
mobile con cristalli
Swarovski® /
Cabinet knob with
Swarovski® crystals

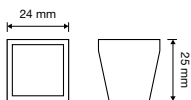

Finiture / Finishes



Swarovski®

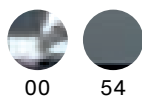

Sogno 1740 PB 0033
Pomolo per
mobile con cristalli
Swarovski® /
Cabinet knob with
Swarovski® crystals

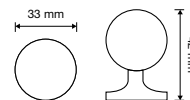
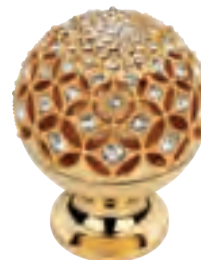

Finiture / Finishes



Ring 320 PB 0030
Pomolo per
mobile con cristalli
Swarovski® /
Cabinet knob with
Swarovski® crystals

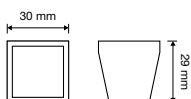

Finiture / Finishes



Swarovski®

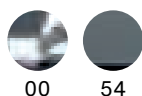

Veronica 201 PB
0024
Pomolo per
mobile con cristalli
Swarovski® /
Cabinet knob with
Swarovski® crystals

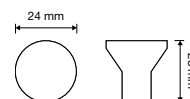

Finiture / Finishes



Rocks 224 PB 0024
Pomolo per
mobile con cristalli
Swarovski® /
Cabinet knob with
Swarovski® crystals

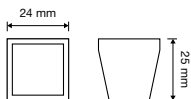

Finiture / Finishes



Swarovski®

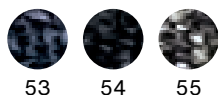

Veronica 201 PB
0034
Pomolo per
mobile con cristalli
Swarovski® /
Cabinet knob with
Swarovski® crystals

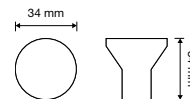

Finiture / Finishes



Chic 1670 PB 0024
Pomolo per mobile /
Cabinet knob

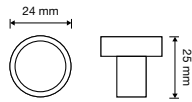

Finiture / Finishes



Rose 996 PB 0030
Pomolo per mobile /
Cabinet knob

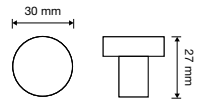

Finiture / Finishes

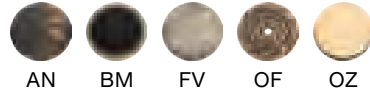

Chic 1670 PB 0034
Pomolo per mobile /
Cabinet knob

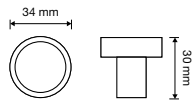

Finiture / Finishes



Sirena 202 PB 0027
Pomolo per mobile /
Cabinet knob

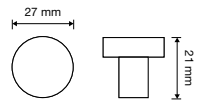

Finiture / Finishes



Daisy 1070 PB 0030
Pomolo per mobile /
Cabinet knob

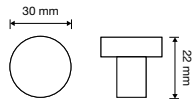

Finiture / Finishes



Sirena 202 PB 0032
Pomolo per mobile /
Cabinet knob

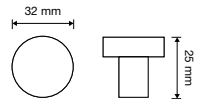

Finiture / Finishes



Frida 1700 PB 0031
Pomolo per mobile /
Cabinet knob

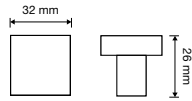

Finiture / Finishes



Vintage 1272 PB
0028
Pomolo per mobile /
Cabinet knob

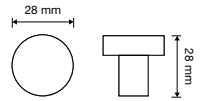

Finiture / Finishes



Vintage 1272 PB
0036
Pomolo per mobile /
Cabinet knob

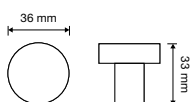

Finiture / Finishes



Rococò 1285 MB
0128
Maniglia per
mobile / Cabinet
handle

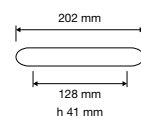

Finiture / Finishes



Vintage 1278 MB
0064
Maniglia per
mobile / Cabinet
handle

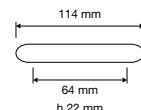

Finiture / Finishes



Maniglie per mobile / Cabinet handles

Frida 1700 MB 0096
Maniglia per
mobile / Cabinet
handle

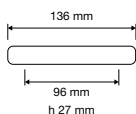

Finiture / Finishes



Vintage 1278 MB
0096
Maniglia per
mobile / Cabinet
handle

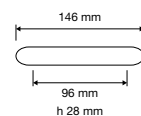

Finiture / Finishes



Rococò 1285 MB
0064
Maniglia per
mobile / Cabinet
handle

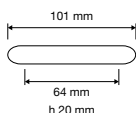

Finiture / Finishes



Vintage 1278 MB
0128
Maniglia per
mobile / Cabinet
handle

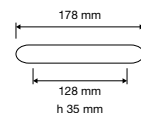

Finiture / Finishes



Rococò 1285 MB
0096
Maniglia per
mobile / Cabinet
handle

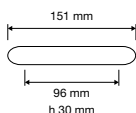

Finiture / Finishes



Istruzioni di montaggio
Assembly instructions

CLICK-CLACK European profile cylinder

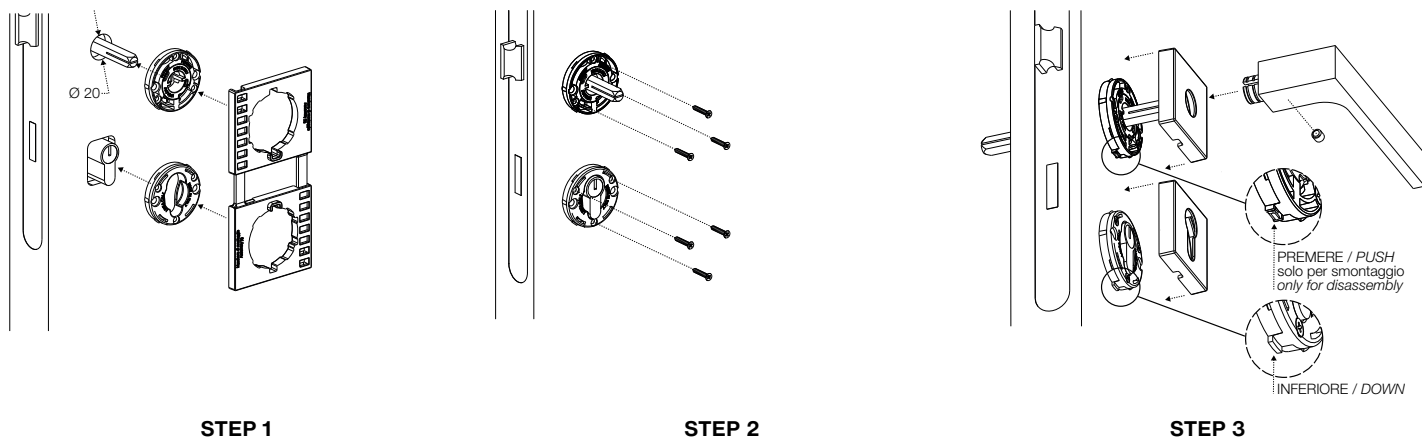

CLICK-CLACK Patent key

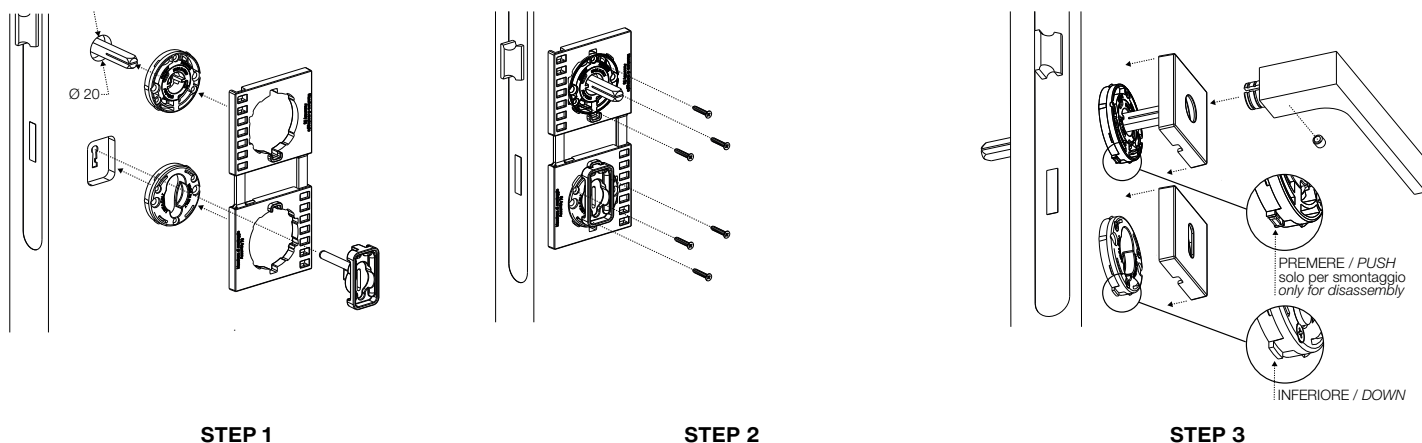

CLICK-CLACK Toilet

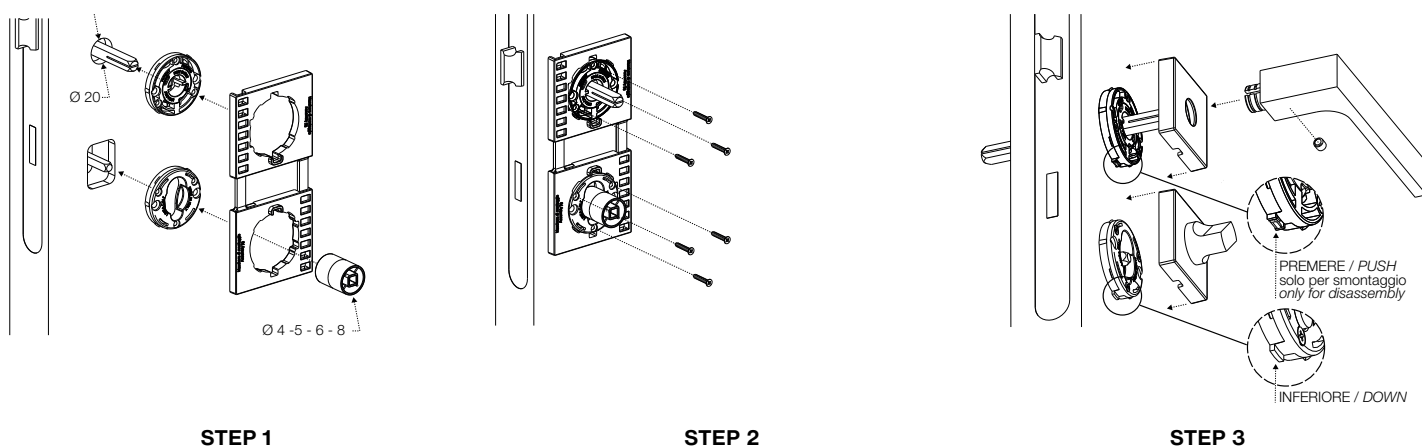

CLICK-CLACK European profile cylinder

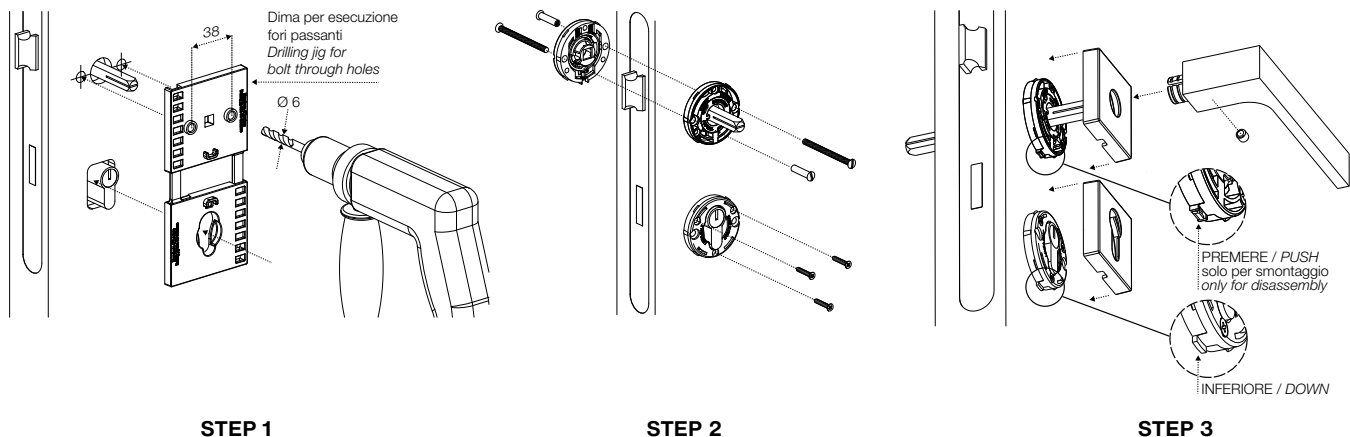

CLICK-CLACK Patent key

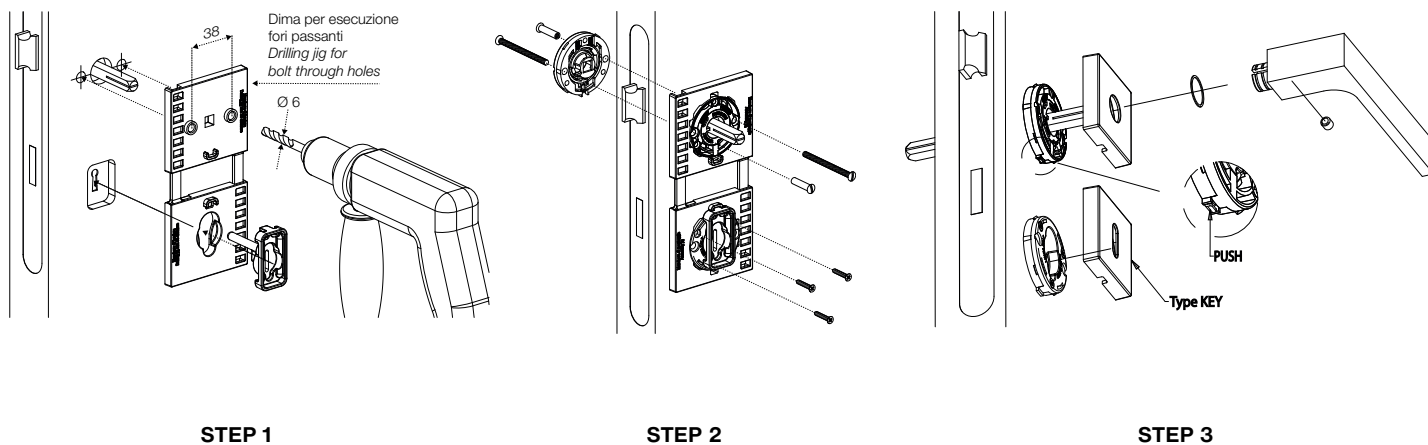

CLICK-CLACK Toilet

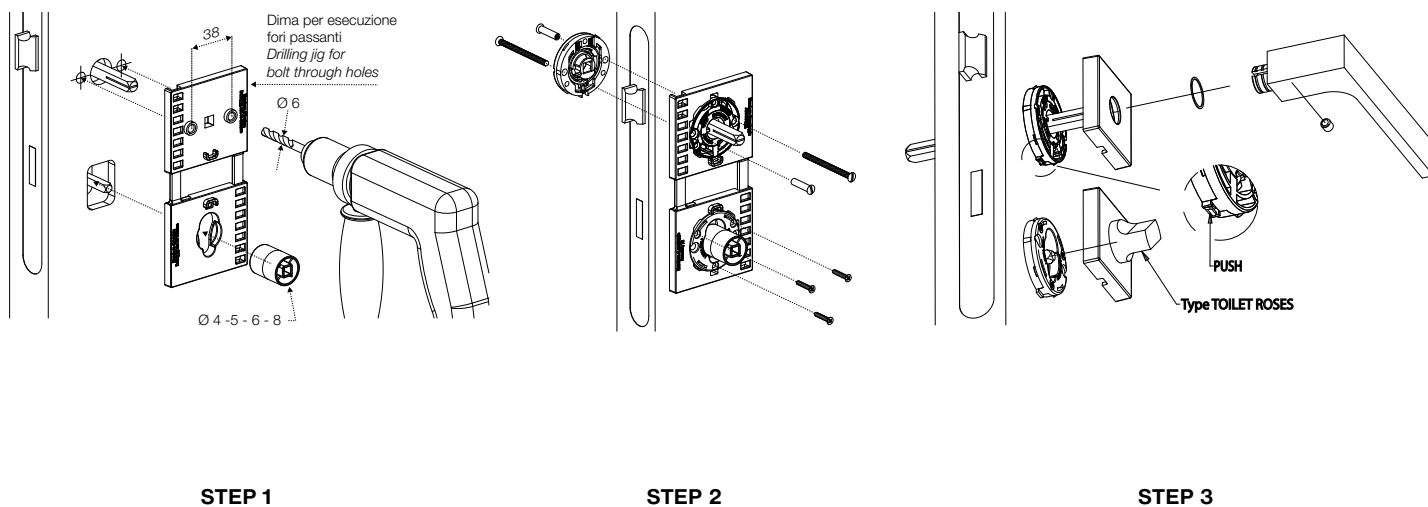

Montaggio maniglia con rosetta e bocchetta 004-007-016-019-023-024-025-114 e pomolo fisso / *Handle fitting with rose and key hole 004-007-016-019-023-024-025-114 and fixed knob*

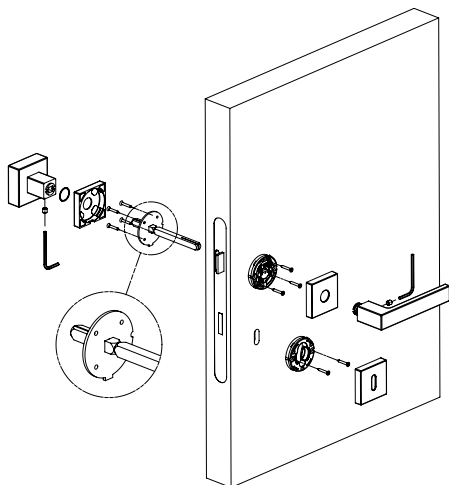

Montaggio maniglia con rosetta e bocchetta 027-088 con viti passanti / *Handle fitting with rose and key hole 027-088 with through screws*

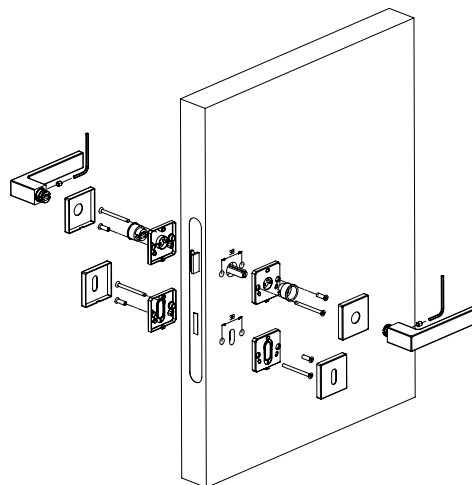

Montaggio maniglia con rosetta e bocchetta 014-027-088 con viti a legno / *Handle fitting with rose and key hole 014-027-088 with wood screws*

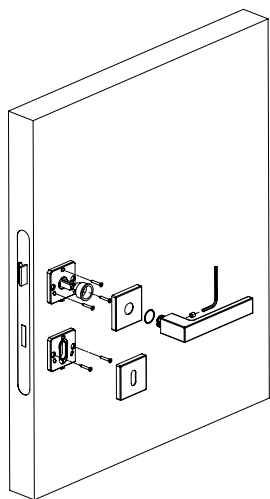

Montaggio maniglia girevole rosetta 014-027-088 con pomolo fisso / *Swing handle fitting with rose 014-027-088 with fixed knob*

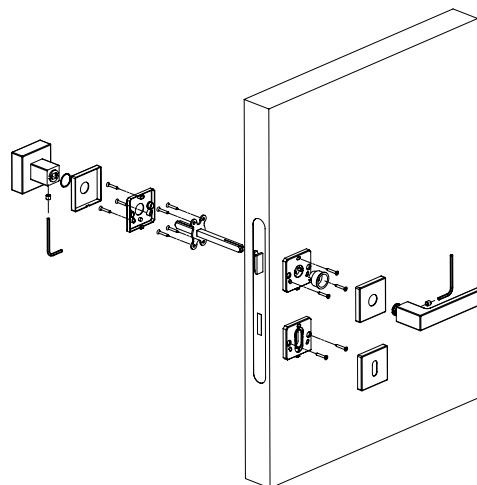

Montaggio maniglia con rosetta 009-011-102-103-108-112-113-115 con viti passanti / *Handle fitting with rose 009-011-102-103-108-112-113-115 with through screws*

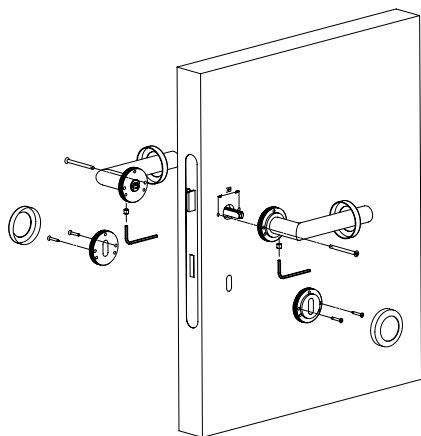

Montaggio maniglia con rosetta e bocchetta 009-011-102-103-108-112-113-115 con viti a legno / *Handle fitting with rose and key hole 009-011-102-103-108-112-113-115 with wood screws*

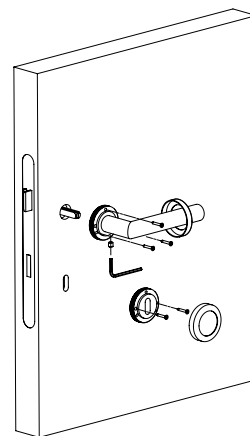

Montaggio maniglia con placca / *Handle fitting with plate*

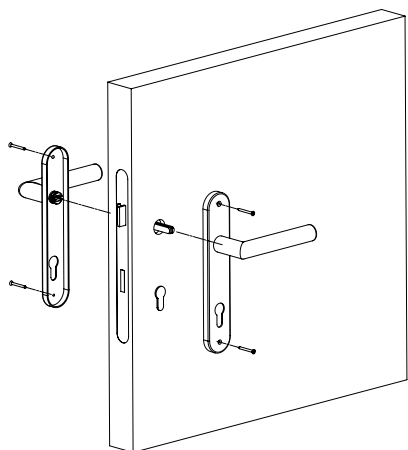

Montaggio maniglia per finestra DK 4-8-scatti / *Handle fitting for tilt windows 4-8-clicks*

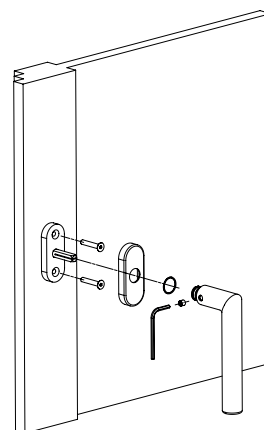

Montaggio maniglia per finestra / *Handle fitting for window*

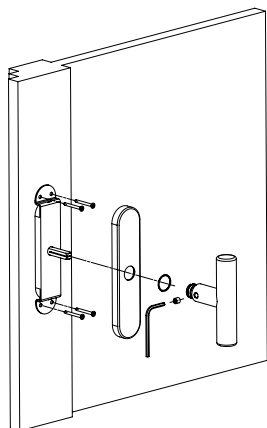

Montaggio kit incasso / *Fitting of built-in kit*

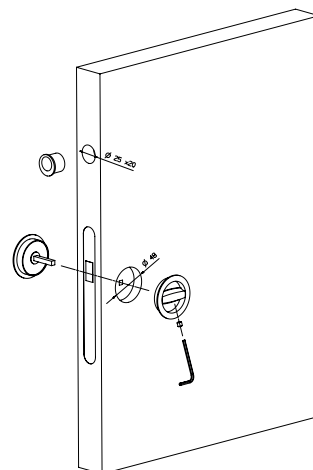

Montaggio maniglione con viti passanti / *Pull handle fitting with through screws*

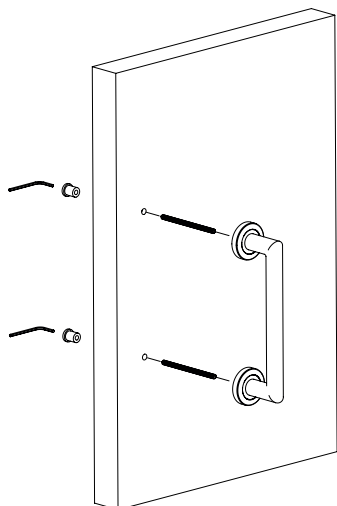

Montaggio coppia di maniglioni con rosetta 011-102-103 / *Fitting of pull handle couple with rose 011-102-103*

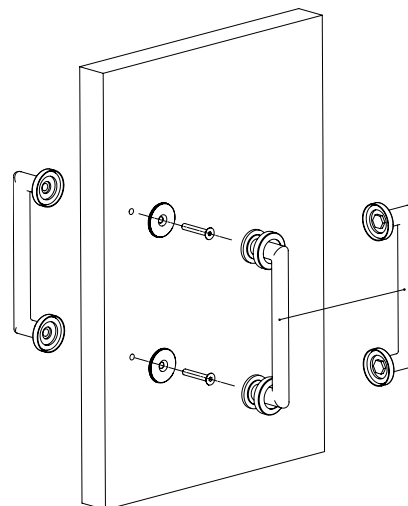

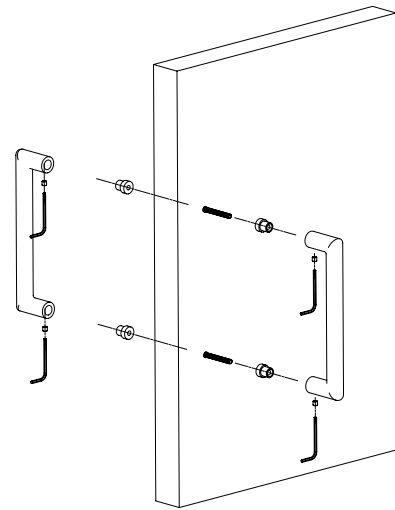
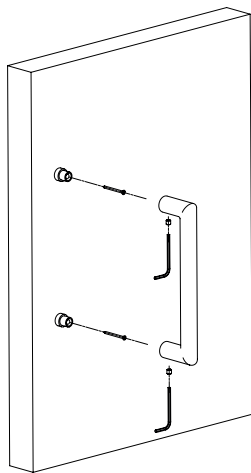

Montaggio maniglione alzante singolo 1615-1616 / *Fitting of single lift pull handle 1615-1616*

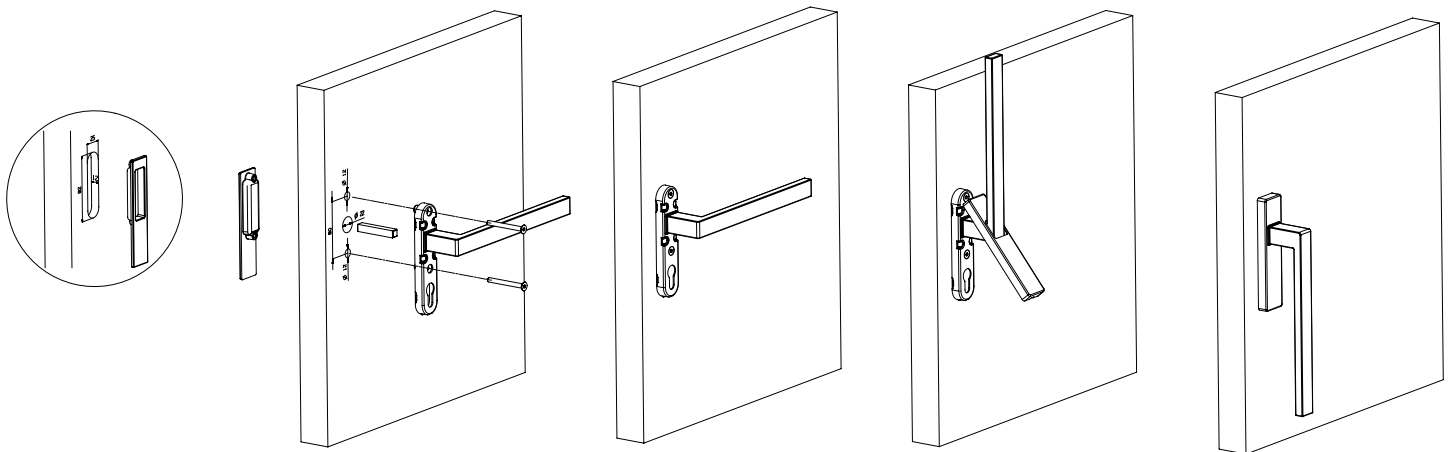

Montaggio maniglione alzante singolo 1617 / *Fitting of single lift pull handle 1617*

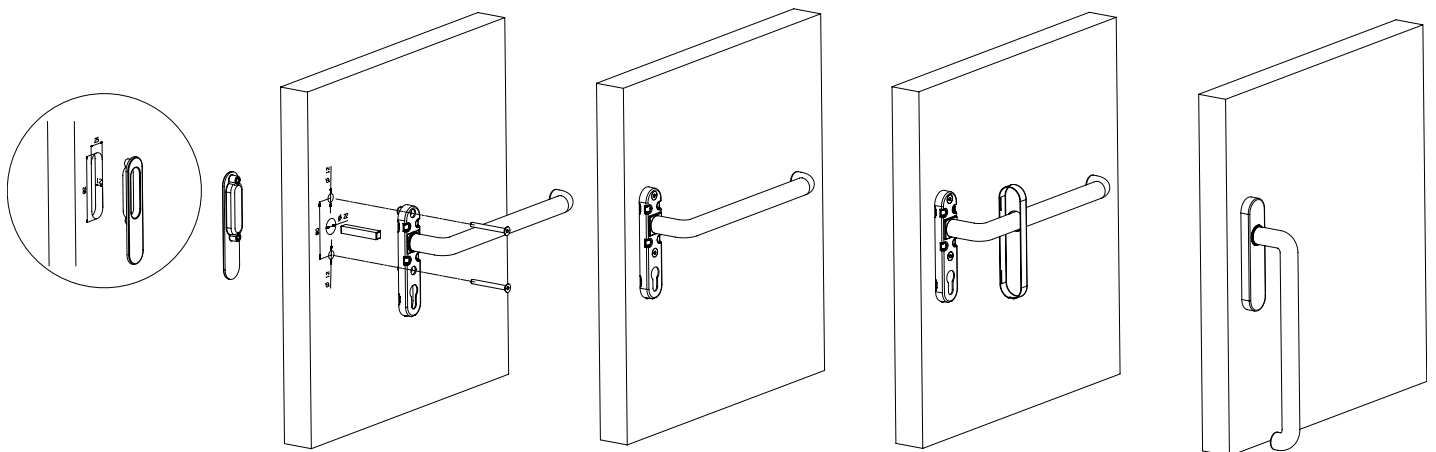

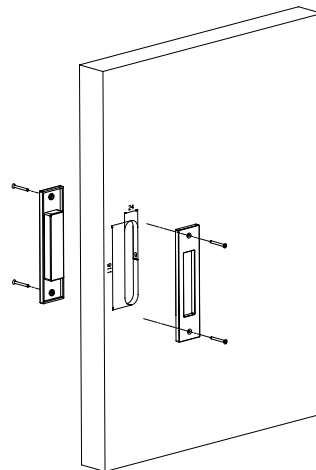
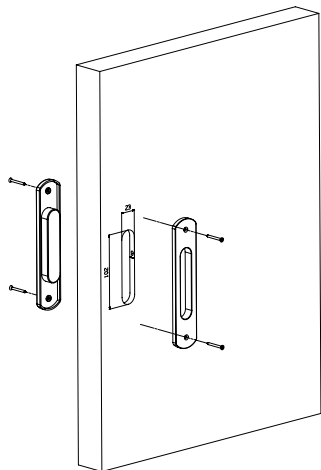
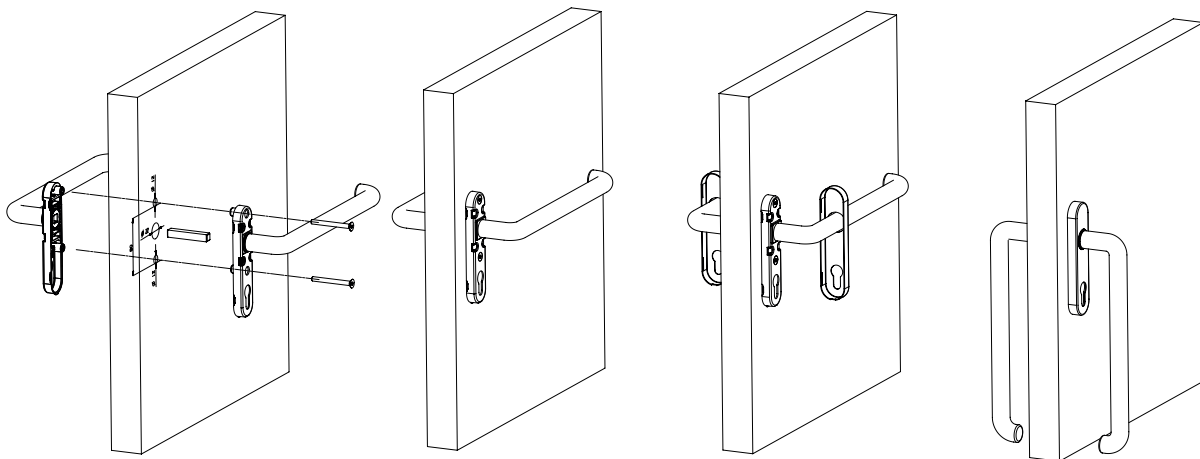
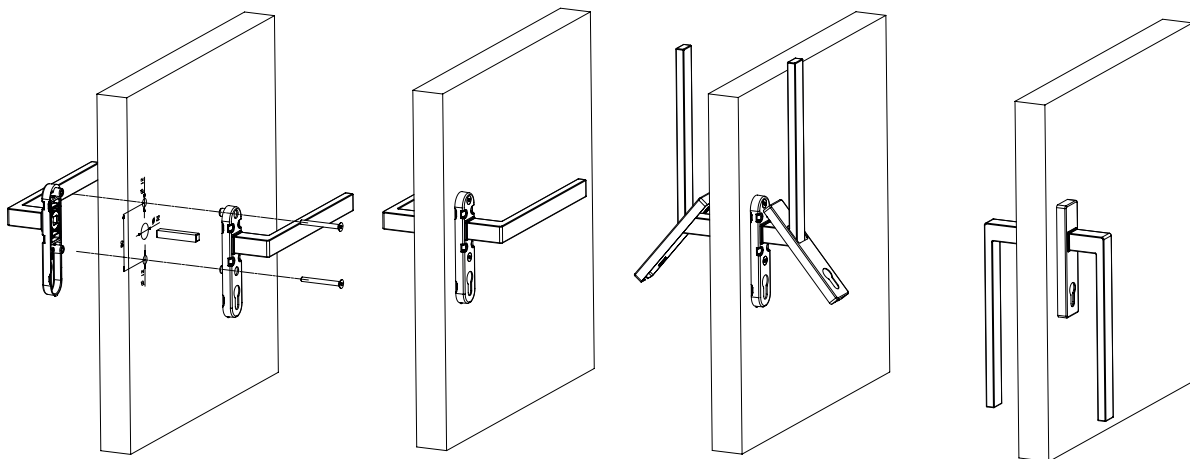

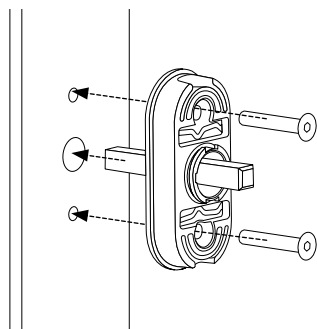

STEP 1

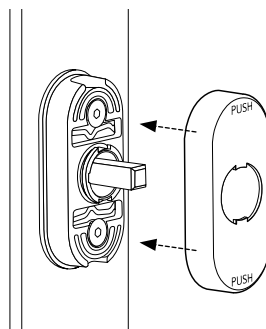

STEP 2

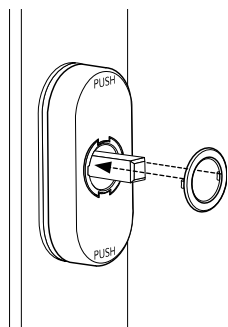

STEP 3

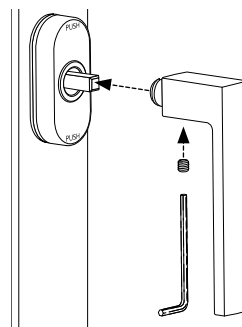
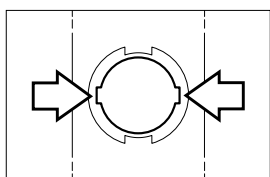

STEP 4

Istruzioni d'uso SmartBlock / SmartBlock instructions for use

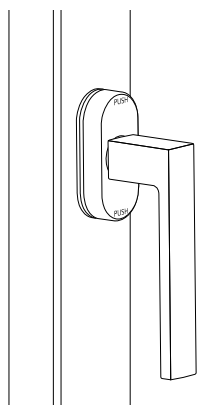

STEP 1

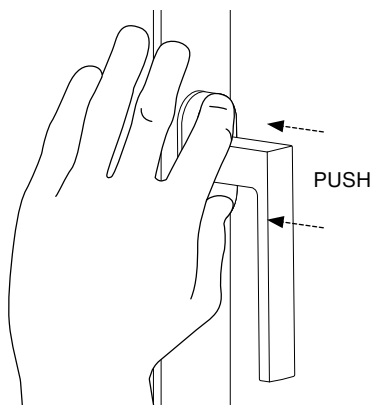

STEP 2

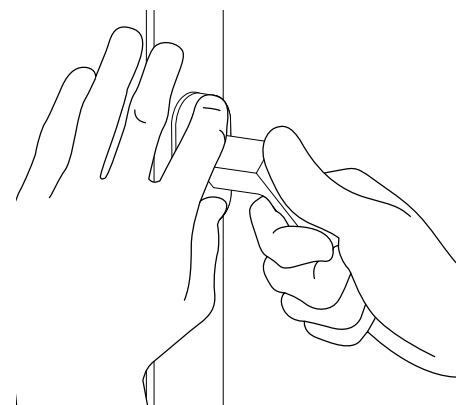

STEP 3

Sostenibilità / *Sustainability*

Il marchio FSC® identifica che questo catalogo è stato stampato su carta contenente legno proveniente da foreste gestite in maniera corretta e responsabile secondo rigorosi standard ambientali, sociali ed economici. La foresta di origine è stata controllata e valutata in maniera indipendente in conformità a questi standard (principi e criteri di buona gestione forestale), stabiliti ed approvati dal Forest Stewardship Council® a.c. tramite la partecipazione e il consenso delle parti interessate.

The FSC® label means the paper in this catalog has been made with wood coming from forests managed in a correct and responsible way, following strict environmental, social and economic standards. The forest of provenance has been controlled and evaluated independently in accordance with specific standards (principles and criteria of good forest management), established and approved by the Forest Stewardship Council® through the participation and consent of the interested parties.



Diritti di autore / *Copyright*

Tutti i diritti sono riservati. È vietata la riproduzione integrale o parziale e la diffusione dei contenuti di questo catalogo (siano essi testi, immagini o disegni) senza la preventiva autorizzazione scritta, da richiedere al seguente indirizzo di posta elettronica: info@lineacali.it.

All rights reserved. It is forbidden to reproduce, in part or in whole, and to circulate the contents of this catalogue (text, images and drawings) without prior written authorization, to be requested at the following email address: info@lineacali.it.

Colophon

Progetto grafico e testi / *Graphic design and copy*
Zack Alberto Bondoni - albertobondoni.it

Foto / *Photo*
Rinaldo Capra
Tiziano Reguzzi

Service di stampa / *Print service*
Intese Grafiche



lineacalì

Linea Calì srl
di Danilo Calì, Paolo Calì e Mario
Facchetti

Via Comunale, 89/91
25079 Vobarno (BS) - Italy

Tel. +39 0365 59 91 98
Fax +39 0365 59 99 71

info@lineacali.it
lineacali.it