

Metal-Bud

PRODUCENT KLAMEK

KLAMKI DO DRZWI
I AKCESORIA



SPIS TREŚCI

PREMIUM	
04-10	KWADRATOWE
11-22	OKRĄGŁE
23-26	INOX
27-40	DŁUGIE
41-45	ZEWNETRZNE
46-49	AKCESORIA
50-59	WKŁADKI
60-63	



Metal-Bud

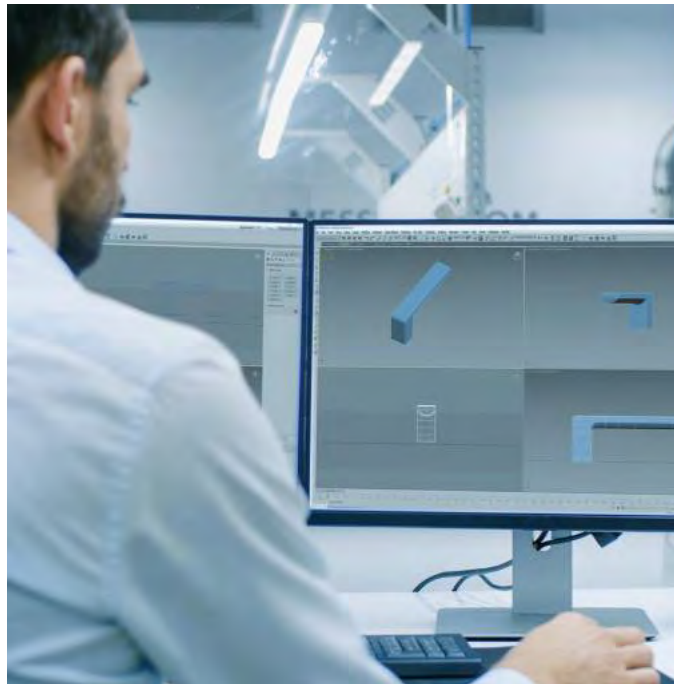

TRADYCJA

Z tradycjami sięgającymi 1965 jesteśmy liderem w produkcji i dystrybucji klamek do drzwi. Nasze klamki otwierają drzwi w Polsce i Europie a ich pełna wzorów i barw gama odzwierciedla aktualne potrzeby europejskich klientów.

DOŚWIADCZENIE

Mamy ponad pół wieku doświadczenia w branży klamek i okuć do drzwi. Projektujemy je, produkujemy i skutecznie dostarczamy do klientów zlokalizowanych na kilku kontynentach.

PROFESJONALIZM

Sprawujemy pieczę nad procesem produkcyjnym od jego samego początku - projektowania, poprzez wykonanie prototypów, nadzór nad produkcją aż do wykonania finalnego produktu.

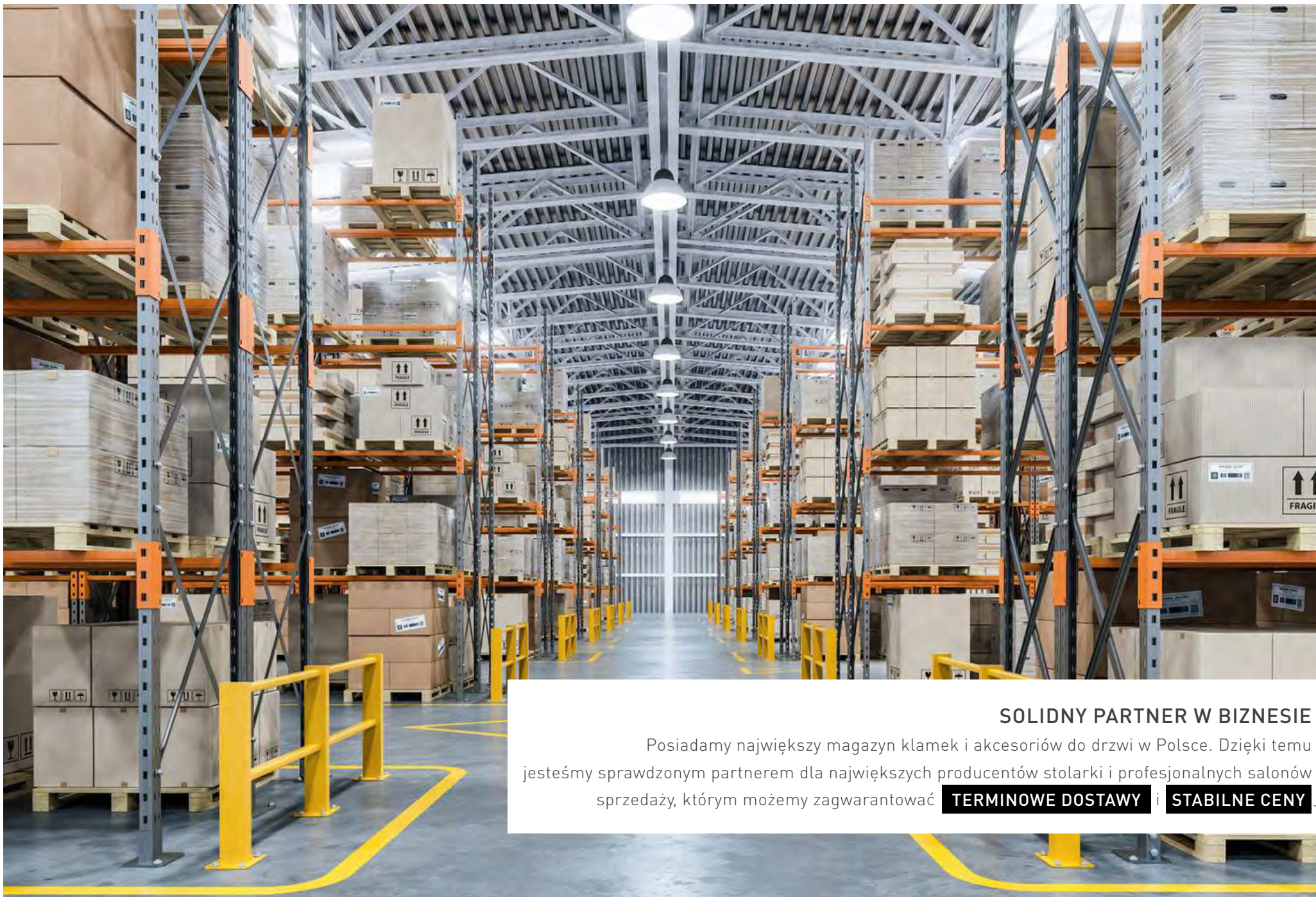

SOLIDNY PARTNER W BIZNESIE

Posiadamy największy magazyn klamek i akcesoriów do drzwi w Polsce. Dzięki temu jesteśmy sprawdzonym partnerem dla największych producentów stolarki i profesjonalnych salonów sprzedaży, którym możemy zagwarantować **TERMINOWE DOSTAWY** i **STABILNE CENY**.

CUBE Q SLIM

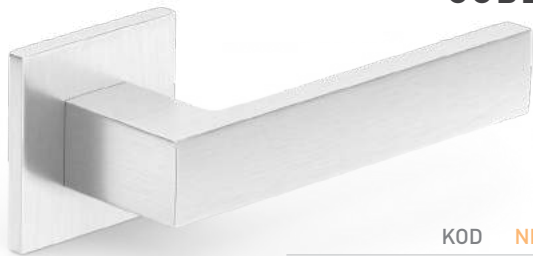

KOD NETTO BRUTTO

	ZCUKSCM	126,02	155,00
	SZQSLCMK	41,78	51,39
	SZQSLCMY	41,78	51,39
	SZQSLCMW	66,07	81,27

CHROM

SZCZOTKOWANY MAT

GRUBOŚĆ ROZETY: 6 mm

CUBE Q SLIM

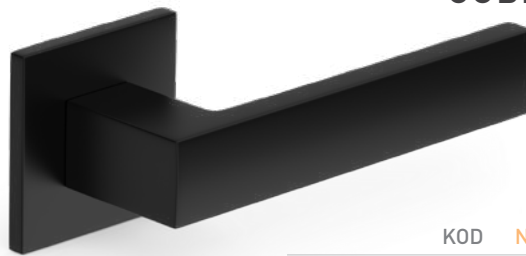

KOD NETTO BRUTTO

	ZCUKSCZ	126,02	155,00
	SZQSLCZK	41,78	51,39
	SZQSLCZY	41,78	51,39
	SZQSLCZW	66,07	81,27

CZARNY

GRUBOŚĆ ROZETY: 6 mm

CUBE Q SLIM

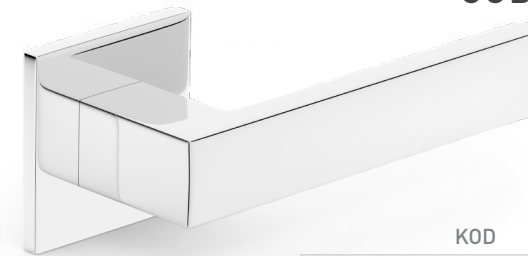

KOD NETTO BRUTTO

	ZCUKSCB	126,02	155,00
	SZQSLCBK	41,78	51,39
	SZQSLCBY	41,78	51,39
	SZQSLCBW	66,07	81,27

CHROM

GRUBOŚĆ ROZETY: 6 mm

CUBE Q SLIM

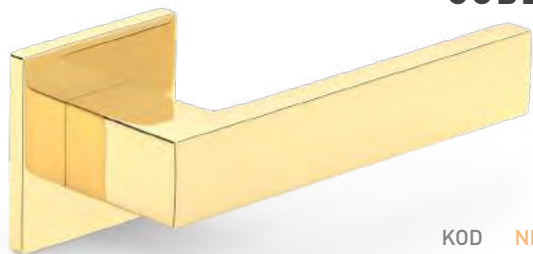

KOD NETTO BRUTTO

	ZCUKSMB	138,21	170,00
	SZQSLMBK	49,78	61,23
	SZQSLMBY	49,78	61,23
	SZQSLMBW	74,20	91,27

MOSIĄDZ PVD

GRUBOŚĆ ROZETY: 6 mm

CUBE Q SLIM

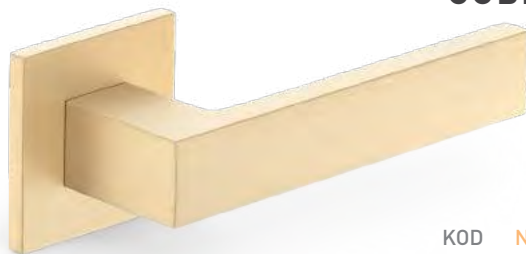

KOD NETTO BRUTTO

	ZCUKSMS	142,28	175,00
	SZQSLMSK	49,78	61,23
	SZQSLMSY	49,78	61,23
	SZQSLMSW	74,20	91,27

MOSIĄDZ

SATYNOWANY

GRUBOŚĆ ROZETY: 6 mm

CUBE Q

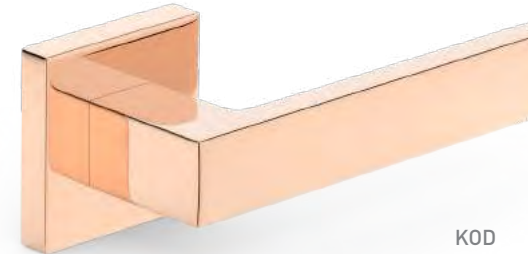

KOD NETTO BRUTTO

	ZCUKRG	121,95	150,00
	SZQRGK	41,34	50,85
	SZQRGY	41,34	50,85
	SZQRGW	74,20	91,27

MIEDŹ PVD

CUBE Q

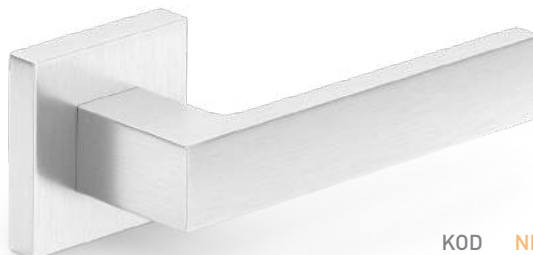

KOD NETTO BRUTTO

	ZCUKCM	97,56	120,00
	SZQCMK	33,52	41,23
	SZQCMY	33,52	41,23
	SZQCMW	58,92	72,47

CHROM

SZCZOTKOWANY MAT

CUBE Q

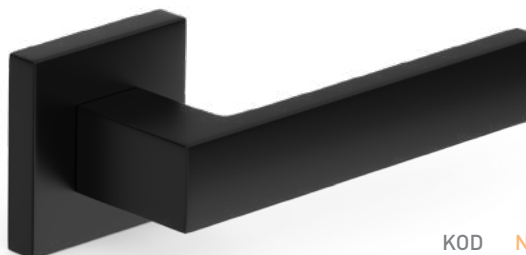

KOD NETTO BRUTTO

	ZCUK CZ	97,56	120,00
	SZQCZK	33,52	41,23
	SZQCZY	33,52	41,23
	SZQCZW	58,92	72,47

CZARNY

CUBE Q

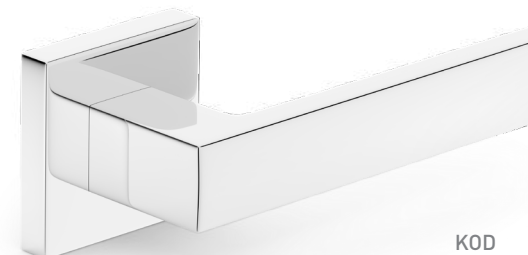

KOD NETTO BRUTTO



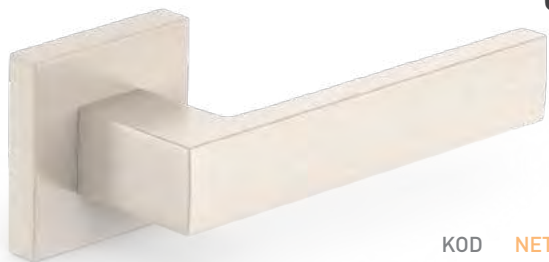

	ZCUKCB	97,56	120,00
	SZQCBK	33,52	41,23
	SZQCBY	33,52	41,23
	SZQCBW	58,92	72,47

CHROM

CUBE Q



NIKIEL
SZCZOTKOWANY MAT

	KOD	NETTO	BRUTTO
	ZCUKNM	97,56	120,00
	SZQNMK	33,52	41,23
	SZQNMY	33,52	41,23
	SZQNMW	58,92	72,47

BELLA R SLIM



CHROM
SZCZOTKOWANY MAT
GRUBOŚĆ ROZETY: 6 mm

	KOD	NETTO	BRUTTO
	ZBEOSCM	117,89	145,00
	SZOSLCMK	41,78	51,39
	SZOSLCMY	41,78	51,39
	SZOSLCMW	66,07	81,27

BELLA R SLIM







CZARNY
GRUBOŚĆ ROZETY: 6 mm

	KOD	NETTO	BRUTTO
	ZBEOSCH	117,89	145,00
	SZOSLCZK	41,78	51,39
	SZOSLCZY	41,78	51,39
	SZOSLCZW	66,07	81,27

BELLA R SLIM







CHROM
GRUBOŚĆ ROZETY: 6 mm

	KOD	NETTO	BRUTTO
	ZBEOSCB	117,89	145,00
	SZOSLCBK	41,78	51,39
	SZOSLCBY	41,78	51,39
	SZOSLCBW	66,07	81,27

BELLA R SLIM





MOSIĄDZ PVD
GRUBOŚĆ ROZETY: 6 mm

	KOD	NETTO	BRUTTO
	ZBEOSMB	134,15	165,00
	SZOSLMBK	49,78	61,23
	SZOSLMBY	49,78	61,23
	SZOSLMBW	74,20	91,27

BELLA R SLIM



MOSIĄDZ
SATYNOWANY
GRUBOŚĆ ROZETY: 6 mm

	KOD	NETTO	BRUTTO
	ZBEOSMS	134,15	165,00
	SZOSLMSK	49,78	61,23
	SZOSLMSY	49,78	61,23
	SZOSLMSW	74,20	91,27

BELLA Q SLIM



CHROM
SZCZOTKOWANY MAT
GRUBOŚĆ ROZETY: 6 mm

	KOD	NETTO	BRUTTO
	ZBEKSCM	126,02	155,00
	SZQSLCMK	41,78	51,39
	SZQSLCMY	41,78	51,39
	SZQSLCMW	66,07	81,27

BELLA Q SLIM



CZARNY
GRUBOŚĆ ROZETY: 6 mm

	KOD	NETTO	BRUTTO
	ZBEKSCZ	126,02	155,00
	SZQSLCZK	41,78	51,39
	SZQSLCZY	41,78	51,39
	SZQSLCZW	66,07	81,27

BELLA Q SLIM

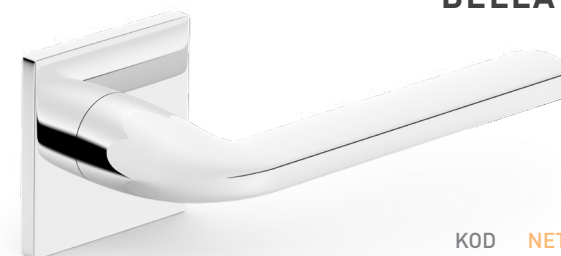

CHROM
GRUBOŚĆ ROZETY: 6 mm

	KOD	NETTO	BRUTTO
	ZBEKSCB	126,02	155,00
	SZQSLCBK	41,78	51,39
	SZQSLCBY	41,78	51,39
	SZQSLCBW	66,07	81,27

BELLA Q SLIM

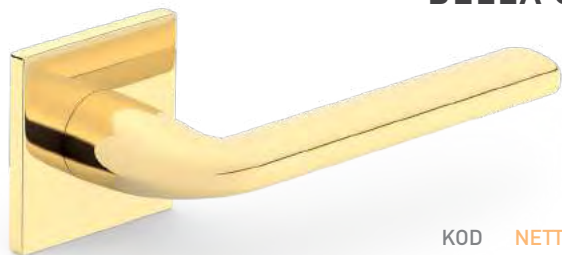

MOSIĄDZ PVD

GRUBOŚĆ ROZETY: 6 mm

	KOD	NETTO	BRUTTO
	ZBEKSMB	142,28	175,00
	SZQSLMBK	49,78	61,23
	SZQSLMBY	49,78	61,23
	SZQSLMBW	74,20	91,27

BELLA Q SLIM



MOSIĄDZ

SATYNOWANY

GRUBOŚĆ ROZETY: 6 mm

	KOD	NETTO	BRUTTO
	ZBEKSMS	142,28	175,00
	SZQSLMSK	49,78	61,23
	SZQSLMSY	49,78	61,23
	SZQSLMSW	74,20	91,27

LUNA R



CHROM

SZCZOTKOWANY MAT

	KOD	NETTO	BRUTTO
	ZLUOCM	97,56	120,00
	SZOCMK	32,06	39,44
	SZOCMY	32,06	39,44
	SZOCMW	56,36	69,32

LUNA R



CZARNY

	KOD	NETTO	BRUTTO
	ZLUOCZ	97,56	120,00
	SZOCZK	32,06	39,44
	SZOCZY	32,06	39,44
	SZOCZW	56,36	69,32

LUNA R



CHROM

	KOD	NETTO	BRUTTO
	ZLUOCB	97,56	120,00
	SZOCBK	32,06	39,44
	SZOCBY	32,06	39,44
	SZOCBW	56,36	69,32

LUNA R



MOSIĄDZ PVD

	KOD	NETTO	BRUTTO
	ZLUOMB	113,82	140,00
	SZOMBK	37,89	46,61
	SZOMBY	37,89	46,61
	SZOMBW	68,02	83,67

LUNA Q

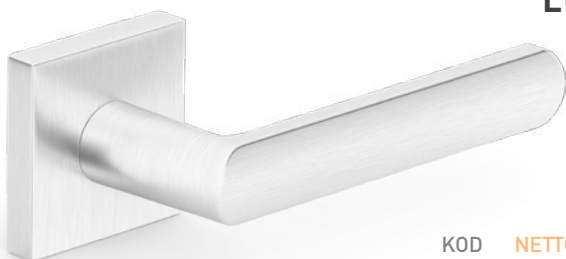

CHROM

SZCZOTKOWANY MAT

	KOD	NETTO	BRUTTO
	ZLUKCM	105,69	130,00
	SZQCMK	33,52	41,23
	SZQCMY	33,52	41,23
	SZQCMW	58,92	72,47

LUNA Q

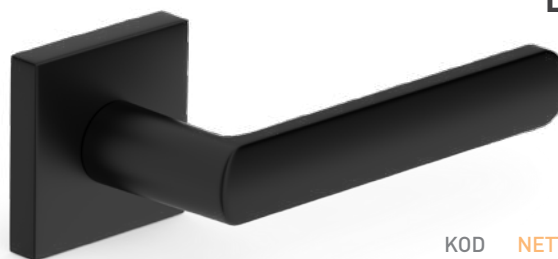

CZARNY

	KOD	NETTO	BRUTTO
	ZLUK CZ	105,69	130,00
	SZQCZK	33,52	41,23
	SZQCZY	33,52	41,23
	SZQCZW	58,92	72,47

LUNA Q

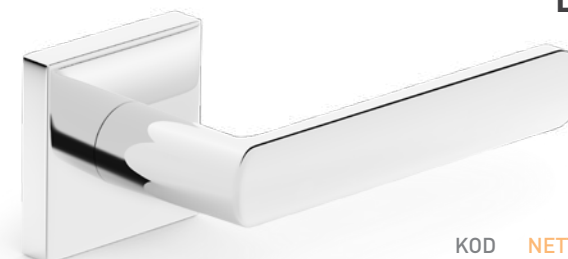

CHROM

	KOD	NETTO	BRUTTO
	ZLUKCB	105,69	130,00
	SZQCBK	33,52	41,23
	SZQCBY	33,52	41,23
	SZQCBW	58,92	72,47

LUNA Q

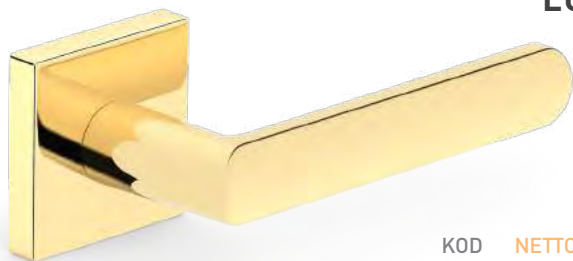

MOSIĄDZ PVD

	KOD	NETTO	BRUTTO
	ZLUKMB	121,95	150,00
	SZQMBK	39,61	48,73
	SZQMBY	39,61	48,73
	SZQMBW	71,11	87,47

JULIA R



CZARNY

	KOD	NETTO	BRUTTO
	ZJUOCZ	105,69	130,00
	SZOCZK	32,06	39,44
	SZOCZY	32,06	39,44
	SZOCZW	56,36	69,32

JULIA R



CHROM

	KOD	NETTO	BRUTTO
	ZJUOCB	105,69	130,00
	SZOCBK	32,06	39,44
	SZOCBY	32,06	39,44
	SZOCBW	56,36	69,32

JULIA R



MOSIĄDZ PVD

	KOD	NETTO	BRUTTO
	ZJUOMB	130,08	160,00
	SZOMBK	37,89	46,61
	SZOMBY	37,89	46,61
	SZOMBW	68,02	83,67

TOTAL Q

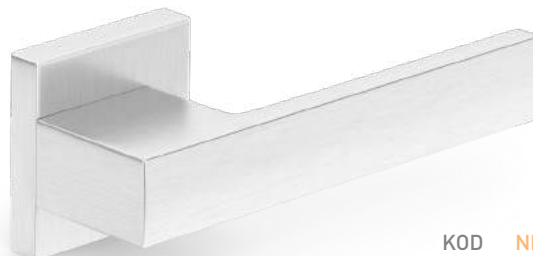

CHROM

SZCZOTKOWANY MAT

	KOD	NETTO	BRUTTO
	ZTOKCM	146,34	180,00
	SZQCMK	33,52	41,23
	SZQCMY	33,52	41,23
	SZQCMW	58,92	72,47

TOTAL Q

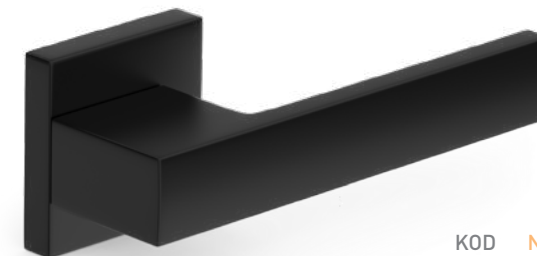

CZARNY

	KOD	NETTO	BRUTTO
	ZTOKCZ	146,34	180,00
	SZQCZK	33,52	41,23
	SZQCZY	33,52	41,23
	SZQCZW	58,92	72,47

TOTAL Q

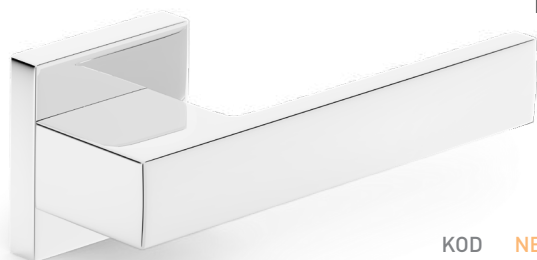

CHROM

	KOD	NETTO	BRUTTO
	ZTOKCB	146,34	180,00
	SZQCBK	33,52	41,23
	SZQCBY	33,52	41,23
	SZQCBW	58,92	72,47

TOTAL Q

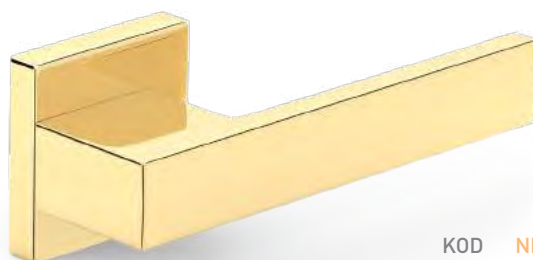

MOSIĄDZ PVD

	KOD	NETTO	BRUTTO
	ZTOKMB	170,73	210,00
	SZQMBK	39,61	48,73
	SZQMBY	39,61	48,73
	SZQMBW	71,11	87,47

TOTAL Q

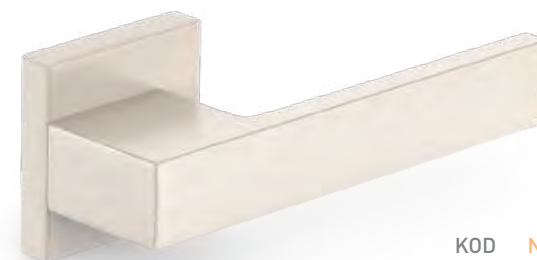

NIKIEL

SZCZOTKOWANY MAT

	KOD	NETTO	BRUTTO
	ZTOKNM	146,34	180,00
	SZQNMK	33,52	41,23
	SZQNMY	33,52	41,23
	SZQNMW	58,92	72,47

CUBE RT



CHROM
SZCZOTKOWANY MAT

	KOD	NETTO	BRUTTO
	ZCUPCM	130,08	160,00
	SZPCMK	40,99	50,41
	SZQCMY	33,52	41,23
	SZPCMW	73,50	90,40

CUBE RT

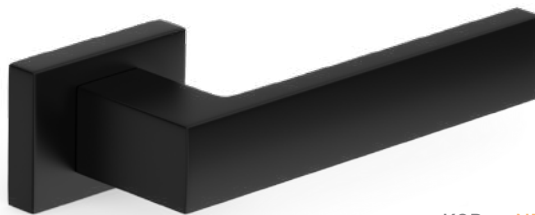

CZARNY

	KOD	NETTO	BRUTTO
	ZCUPCZ	130,08	160,00
	SZPCZK	40,99	50,41
	SZQCZY	33,52	41,23
	SZPCZW	73,50	90,40

CUBE RT

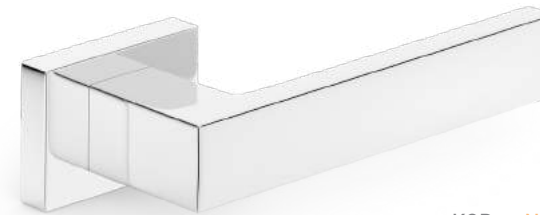

CHROM

	KOD	NETTO	BRUTTO
	ZCUPCB	130,08	160,00
	SZPCBK	40,99	50,41
	SZQCBY	33,52	41,23
	SZPCBW	73,50	90,40

CUBE RT



NIKIEL
SZCZOTKOWANY MAT

	KOD	NETTO	BRUTTO
	ZCUPNM	130,08	160,00
	SZPNMK	40,99	50,41
	SZQNMY	33,52	41,23
	SZPNMW	73,50	90,40

GAŁKA R SLIM



CHROM
SZCZOTKOWANY MAT
GRUBOŚĆ ROZETY: 6 mm

Cena za 1 szt. w konfiguracji stałej lub obrotowej*

	KOD	NETTO	BRUTTO
	ZGOOSCM	117,48	144,50
	SZOSLCMK	41,78	51,39
	SZOSLCMY	41,78	51,39
	SZOSLCMW	66,07	81,27

GAŁKA R SLIM



MOSIĄDZ
SATYNOWANY
GRUBOŚĆ ROZETY: 6 mm

Cena za 1 szt. w konfiguracji stałej lub obrotowej*

	KOD	NETTO	BRUTTO
	ZGOOSMS	133,74	164,50
	SZOSLMSK	49,78	61,23
	SZOSLMSY	49,78	61,23
	SZOSLMSW	74,20	91,27

GAŁKA R SLIM



CZARNY
GRUBOŚĆ ROZETY: 6 mm

Cena za 1 szt. w konfiguracji stałej lub obrotowej*

	KOD	NETTO	BRUTTO
	ZGOOS CZ	117,48	144,50
	SZOSLCZK	41,78	51,39
	SZOSLCZY	41,78	51,39
	SZOSLCZW	66,07	81,27

GAŁKA R SLIM



MOSIĄDZ PVD
GRUBOŚĆ ROZETY: 6 mm

Cena za 1 szt. w konfiguracji stałej lub obrotowej*

	KOD	NETTO	BRUTTO
	ZGOOSMB	133,74	164,50
	SZOSLMBK	49,78	61,23
	SZOSLMBY	49,78	61,23
	SZOSLMBW	74,20	91,27

GAŁKA R SLIM



CHROM
GRUBOŚĆ ROZETY: 6 mm

Cena za 1 szt. w konfiguracji stałej lub obrotowej*

	KOD	NETTO	BRUTTO
	ZGOOSCB	117,48	144,50
	SZOSLCBK	41,78	51,39
	SZOSLCBY	41,78	51,39
	SZOSLCBW	66,07	81,27

OLIVIA R *classic*

NOWOŚĆ



CZARNY

DOSTĘPNE OD 1.06.2022

	KOD	NETTO	BRUTTO
	ZOLOCLCZ	145,53	179,00
	SZOCLCZK	32,52	40,00
	SZOCLCZY	32,52	40,00
	SZOCLCZW	44,72	55,00

OLIVIA R *classic*

NOWOŚĆ



CHROM

DOSTĘPNE OD 1.06.2022

	KOD	NETTO	BRUTTO
	ZOLOCLCB	145,53	179,00
	SZOCLCBK	32,52	40,00
	SZOCLCZY	32,52	40,00
	SZOCLCBW	44,72	55,00

OLIVIA R *classic*

NOWOŚĆ



MOSIĄDZ PVD

DOSTĘPNE OD 1.06.2022

	KOD	NETTO	BRUTTO
	ZOLOCLMB	161,79	199,00
	SZOCLMBK	40,65	50,00
	SZOCLMBY	40,65	50,00
	SZOCLMBW	52,85	65,00

LAURA R *classic*

NOWOŚĆ



CHROM

DOSTĘPNE OD 1.06.2022

	KOD	NETTO	BRUTTO
	ZLAOCLCB	88,62	109,00
	SZOCLCBK	32,52	40,00
	SZOCLCZY	32,52	40,00
	SZOCLCBW	44,72	55,00

LAURA R *classic*

NOWOŚĆ



MOSIĄDZ PVD

DOSTĘPNE OD 1.06.2022

	KOD	NETTO	BRUTTO
	ZLAOCLMB	101,63	125,00
	SZOCLMBK	40,65	50,00
	SZOCLMBY	40,65	50,00
	SZOCLMBW	52,85	65,00

LAURA R *classic*

NOWOŚĆ



CZARNY

DOSTĘPNE OD 1.06.2022

	KOD	NETTO	BRUTTO
	ZLAOCLCZ	88,62	109,00
	SZOCLCZK	32,52	40,00
	SZOCLCZY	32,52	40,00
	SZOCLCZW	44,72	55,00

GAŁKA R



CHROM

SZCZOTKOWANY MAT

Cena za 1 szt. w konfiguracji stałej lub obrotowej*

	KOD	NETTO	BRUTTO
	ZGOOCM	109,35	134,50
	SZOOCMK	32,06	39,44
	SZOOCMY	32,06	39,44
	SZOOCMW	56,36	69,32



CZARNY

GAŁKA R

Cena za 1 szt. w konfiguracji stałej lub obrotowej*

	KOD	NETTO	BRUTTO
	ZGOOCZ	109,35	134,50
	SZOOCZK	32,06	39,44
	SZOOCZY	32,06	39,44
	SZOOCZW	56,36	69,32

GAŁKA R

Cena za 1 szt. w konfiguracji stałej lub obrotowej*



CHROM

	KOD	NETTO	BRUTTO
	ZGOOCB	109,35	134,50
	SZOOCBK	32,06	39,44
	SZOOCBY	32,06	39,44
	SZOOCBW	56,36	69,32



GAŁKA R

Cena za 1 szt. w konfiguracji stałej lub obrotowej*

	KOD	NETTO	BRUTTO
○	ZGOOMB	121,54	149,50
⓪	SZOMBK	37,89	46,61
⓪	SZOMBY	37,89	46,61
⓪	SZOMBW	68,02	83,67

MOSIĄDZ PVD

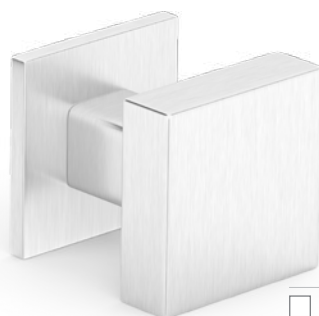

GAŁKA Q SLIM

Cena za 1 szt. w konfiguracji stałej lub obrotowej*

	KOD	NETTO	BRUTTO
□	ZGKKSCM	105,28	129,50
⓪	SZQSLCMK	41,78	51,39
⓪	SZQSLCMY	41,78	51,39
⓪	SZQSLCMW	66,07	81,27

CHROM

SZCZOTKOWANY MAT

GRUBOŚĆ ROZETY: 6 mm

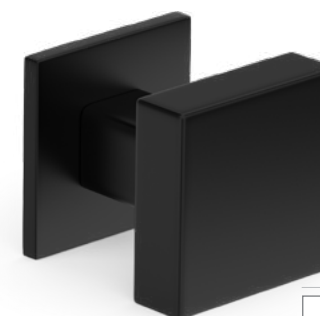

GAŁKA Q SLIM

Cena za 1 szt. w konfiguracji stałej lub obrotowej*

	KOD	NETTO	BRUTTO
□	ZGKKSCZ	105,28	129,50
⓪	SZQSLCZK	41,78	51,39
⓪	SZQSLCZY	41,78	51,39
⓪	SZQSLCZW	66,07	81,27

CZARNY

GRUBOŚĆ ROZETY: 6 mm



GAŁKA Q SLIM

Cena za 1 szt. w konfiguracji stałej lub obrotowej*

	KOD	NETTO	BRUTTO
□	ZGKKSCB	105,28	129,50
⓪	SZQSLCBK	41,78	51,39
⓪	SZQSLCBY	41,78	51,39
⓪	SZQSLCBW	66,07	81,27

CHROM

GRUBOŚĆ ROZETY: 6 mm

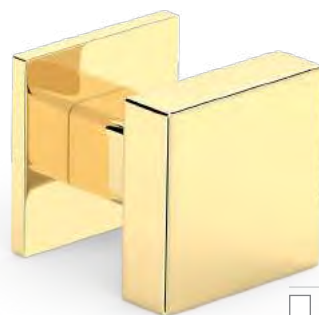

GAŁKA Q SLIM

Cena za 1 szt. w konfiguracji stałej lub obrotowej*

	KOD	NETTO	BRUTTO
□	ZGKKSMB	117,48	144,50
⓪	SZQSLMBK	49,78	61,23
⓪	SZQSLMBY	49,78	61,23
⓪	SZQSLMBW	74,20	91,27

MOSIĄDZ PVD

GRUBOŚĆ ROZETY: 6 mm



GAŁKA Q SLIM

Cena za 1 szt. w konfiguracji stałej lub obrotowej*

	KOD	NETTO	BRUTTO
□	ZGKKSMS	117,48	144,50
⓪	SZQSLMSK	49,78	61,23
⓪	SZQSLMSY	49,78	61,23
⓪	SZQSLMSW	74,20	91,27

MOSIĄDZ

SATYNOWANY

GRUBOŚĆ ROZETY: 6 mm

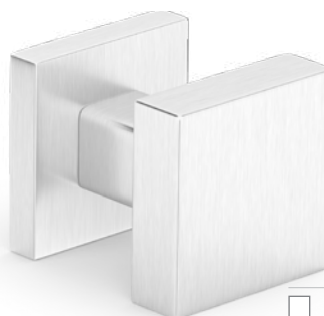

GAŁKA Q

Cena za 1 szt. w konfiguracji stałej lub obrotowej*

	KOD	NETTO	BRUTTO
□	ZGKKCM	97,15	119,50
⓪	SZQCMK	33,52	41,23
⓪	SZQCMY	33,52	41,23
⓪	SZQCMW	58,92	72,47

CHROM

SZCZOTKOWANY MAT

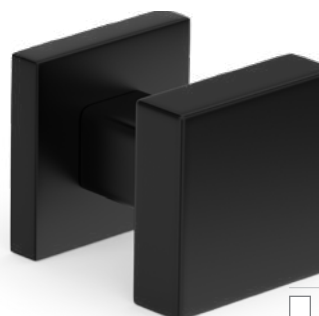

GAŁKA Q

Cena za 1 szt. w konfiguracji stałej lub obrotowej*

	KOD	NETTO	BRUTTO
□	ZGKKCZ	97,15	119,50
⓪	SZQCZK	33,52	41,23
⓪	SZQCZY	33,52	41,23
⓪	SZQCZW	58,92	72,47

CZARNY

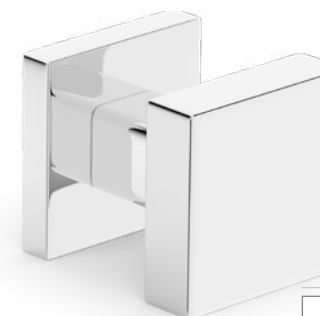

GAŁKA Q

Cena za 1 szt. w konfiguracji stałej lub obrotowej*

	KOD	NETTO	BRUTTO
□	ZGKKCB	97,15	119,50
⓪	SZQCBK	33,52	41,23
⓪	SZQCBY	33,52	41,23
⓪	SZQCBW	58,92	72,47

CHROM



LUNA

NOWOŚĆ

MOSIĄDZ PVD
DOSTĘPNE OD 1.06.2022

	KOD	NETTO	BRUTTO
	LU7KMB	129,27	159,00
	LU7YMB	129,27	159,00
	LU7WMB	153,66	189,00
	LUBMB	129,27	159,00



JULIA

NOWOŚĆ

MOSIĄDZ PVD
DOSTĘPNE OD 1.06.2022

	KOD	NETTO	BRUTTO
	JU7KMB	137,40	169,00
	JU7YMB	137,40	169,00
	JU7WMB	161,79	199,00
	JUBMB	137,40	169,00

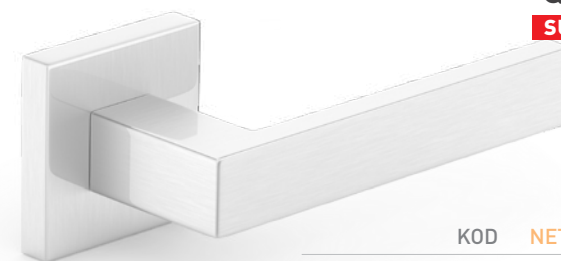

QUBIK K

SUPER CENA

NIKIEL
SZCZOTKOWANY

	KOD	NETTO	BRUTTO
	VQKNS	55,65	68,45
	SZKNSK	28,27	34,77
	SZKNSY	28,27	34,77
	SZKNSW	38,87	47,81

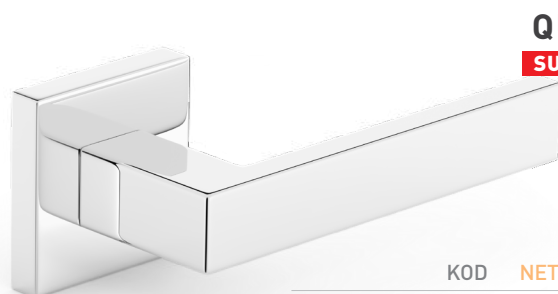

QUBIK K

SUPER CENA

CHROM

	KOD	NETTO	BRUTTO
	VQKCB	59,36	73,01
	SZKCBK	31,54	38,79
	SZKCBY	31,54	38,79
	SZKCBW	44,52	54,76

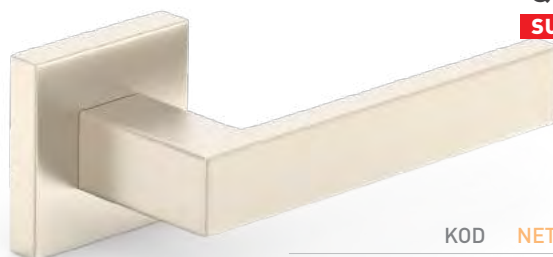

QUBIK K

SUPER CENA

NIKIEL
SATYNA VELVET

	KOD	NETTO	BRUTTO
	VQKNV	59,36	73,01
	SZKNVK	31,54	38,79
	SZKNVY	31,54	38,79
	SZKNVW	44,52	54,76

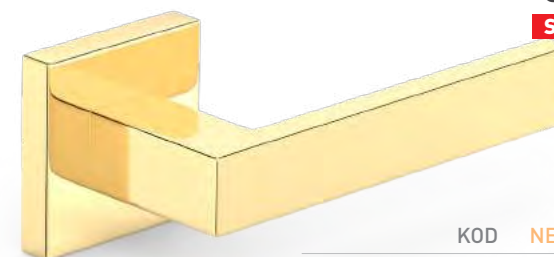

QUBIK K

SUPER CENA

MOSIĄDZ
BŁYSZCZĄCY

	KOD	NETTO	BRUTTO
	VQKMB	74,20	91,27
	SZKMBK	40,81	50,20
	SZKMBY	40,81	50,20
	SZKMBW	63,07	77,58

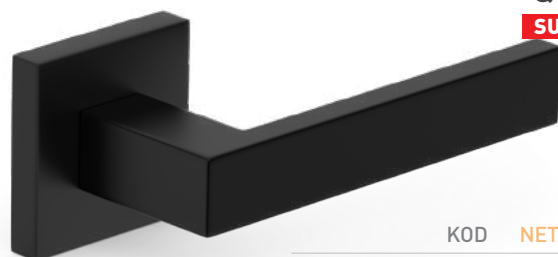

QUBIK K

SUPER CENA

CZARNY

	KOD	NETTO	BRUTTO
	VQKCZ	55,65	68,45
	SZKCK	29,68	36,51
	SZKCY	29,68	36,51
	SZKCW	40,81	50,20



QUBIK K

SUPER CENA

BIAŁY

	KOD	NETTO	BRUTTO
	VQKBI	55,65	68,45
	SZKBK	29,68	36,51
	SZKBY	29,68	36,51
	SZKBW	40,81	50,20



QUBIK K ANTYPAKTERYJNY

Active+
klamki antybakteryjne

CZARNY

	KOD	NETTO	BRUTTO
	VQKCZA	77,73	95,61
	SZKCK	29,68	36,51
	SZKCY	29,68	36,51
	SZKCWA	62,19	76,49

KWADRATOWE

RUMBA K ANTYBAKTERYJNA



Active+
klamki antybakteryjne

	KOD	NETTO	BRUTTO
	VRUKCZA	74,20	91,27
	SZKCK	29,68	36,51
	SZKCY	29,68	36,51
	SZKCWA	62,19	76,49

CZARNY

BARCELONA K ANTYBAKTERYJNA

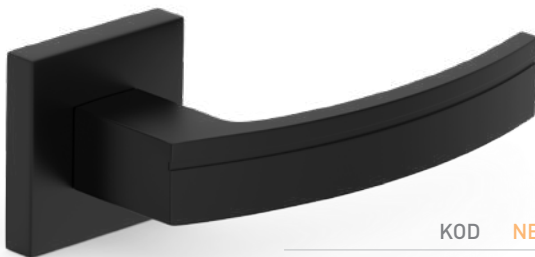

Active+
klamki antybakteryjne

	KOD	NETTO	BRUTTO
	VBAKCZA	74,20	91,27
	SZKCK	29,68	36,51
	SZKCY	29,68	36,51
	SZKCWA	62,19	76,49

CZARNY

IBIZA K

SUPER CENA

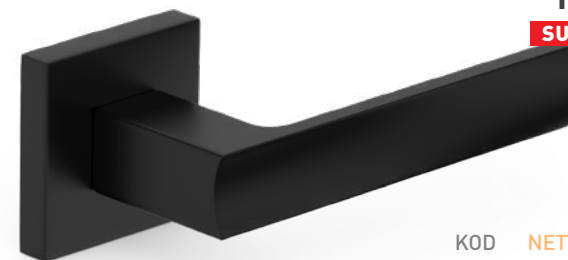

	KOD	NETTO	BRUTTO
	ZIBZCZK	52,50	64,58
	SZKCK	29,68	36,51
	SZKCY	29,68	36,51
	SZKCW	40,81	50,20

CZARNY

IBIZA K

SUPER CENA

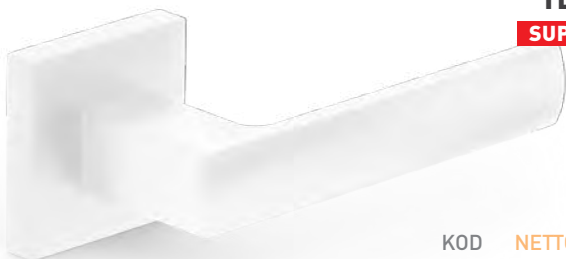

	KOD	NETTO	BRUTTO
	ZIBZBIK	52,50	64,58
	SZKBK	29,68	36,51
	SZKBY	29,68	36,51
	SZKBW	40,81	50,20

BIAŁY

FOKS K

NOWOŚĆ SUPER CENA

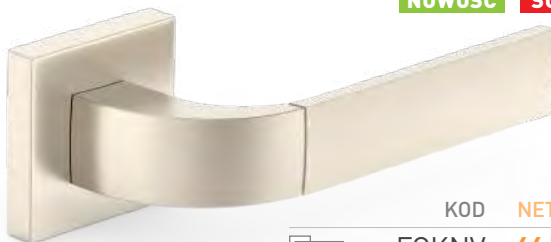

	KOD	NETTO	BRUTTO
	FOKNV	44,72	55,00
	SZKNVK	31,54	38,79
	SZKNVY	31,54	38,79
	SZKNVW	44,52	54,76

NIKIEL
SATYNA VELVET

FOKS K

NOWOŚĆ SUPER CENA

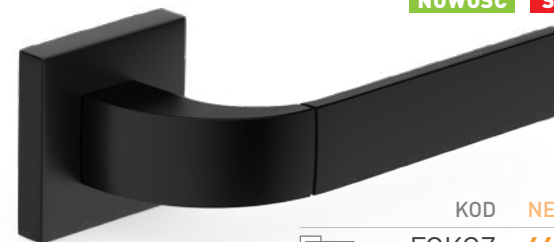

	KOD	NETTO	BRUTTO
	FOKCZ	44,72	55,00
	SZKCK	29,68	36,51
	SZKCY	29,68	36,51
	SZKCW	40,81	50,20

CZARNY

QUANTA K FIT

NOWOŚĆ



	KOD	NETTO	BRUTTO
	QUKFINS	60,98	75,00
	SZKFINSK	31,71	39,00
	SZKFINSY	31,71	39,00
	SZKFINSW	43,90	54,00

NIKIEL
SZCZOTKOWANY

QUANTA K FIT

NOWOŚĆ



	KOD	NETTO	BRUTTO
	QUKFICZ	60,98	75,00
	SZKFICZK	31,71	39,00
	SZKFICZY	31,71	39,00
	SZKFICZW	43,90	54,00

CZARNY

QUANTA K FIT

NOWOŚĆ



	KOD	NETTO	BRUTTO
	QUKFIMS	60,98	75,00
	SZKFIMSK	31,71	39,00
	SZKFIMSY	31,71	39,00
	SZKFIMSW	43,90	54,00

MOSIĄDZ
SZCZOTKOWANY

QUBIK K FIT

NOWOŚĆ

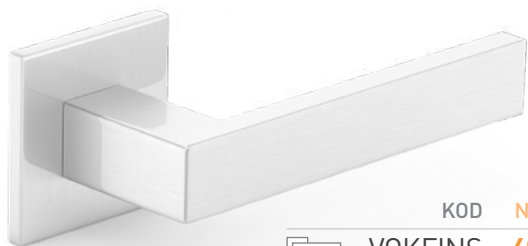

KOD NETTO BRUTTO

	VQKFINS	60,98	75,00
	SZKFINSK	31,71	39,00
	SZKFINSY	31,71	39,00
	SZKFINSW	43,90	54,00

NIKIEL
SZCZOTKOWANY

QUBIK K FIT

NOWOŚĆ



KOD NETTO BRUTTO

	VQKFICZ	60,98	75,00
	SZKFICZK	31,71	39,00
	SZKFICZY	31,71	39,00
	SZKFICZW	43,90	54,00

CZARNY

QUBIK K FIT

NOWOŚĆ

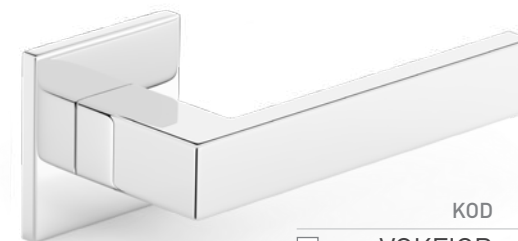

KOD NETTO BRUTTO

	VQKFICB	60,98	75,00
	SZKFICBK	31,71	39,00
	SZKFICBY	31,71	39,00
	SZKFICBW	43,90	54,00

CHROM
BŁYSZCZĄCY

QUBIK K FIT

NOWOŚĆ

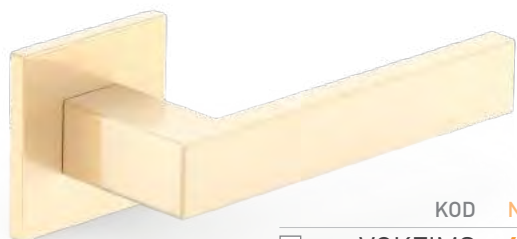

KOD NETTO BRUTTO

	VQKFIMS	60,98	75,00
	SZKFIMSK	31,71	39,00
	SZKFIMSY	31,71	39,00
	SZKFIMSW	43,90	54,00

MOSIĄDZ
SZCZOTKOWANY

QUANTA K FIT

NOWOŚĆ

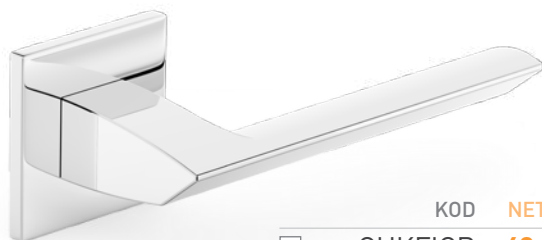

KOD NETTO BRUTTO

	QUKFICB	60,98	75,00
	SZKFICBK	31,71	39,00
	SZKFICBY	31,71	39,00
	SZKFICBW	43,90	54,00

CHROM
BŁYSZCZĄCY



KOLEKCJA FIT

BARCELONA K

SUPER CENA

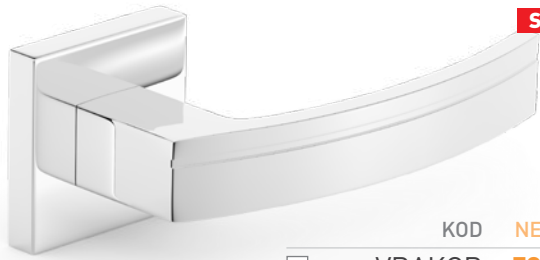

CHROM

	KOD	NETTO	BRUTTO
	VBAKCB	59,36	73,01
	SZKCBK	31,54	38,79
	SZKCBY	31,54	38,79
	SZKCBW	44,52	54,76

BARCELONA K

SUPER CENA

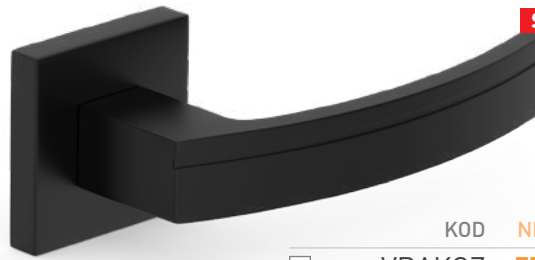

CZARNY

	KOD	NETTO	BRUTTO
	VBAKCB	55,65	68,45
	SZKCK	29,68	36,51
	SZKCY	29,68	36,51
	SZKCBW	40,81	50,20

BARCELONA K

SUPER CENA

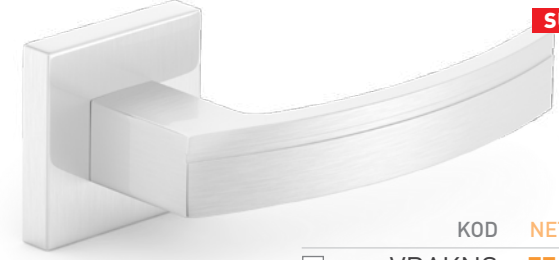

NIKIEL
SZCZOTKOWANY

	KOD	NETTO	BRUTTO
	VBAKNS	55,65	68,45
	SZKNSK	28,27	34,77
	SZKNSY	28,27	34,77
	SZKNSW	38,87	47,81

RUMBA K

SUPER CENA

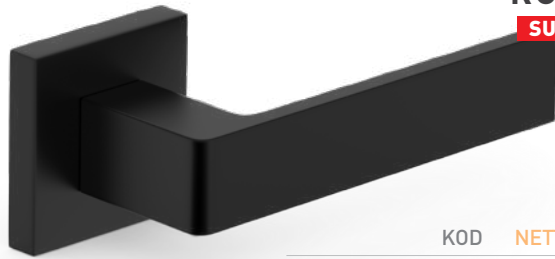

CZARNY

	KOD	NETTO	BRUTTO
	VRUKCZ	55,65	68,45
	SZKCK	29,68	36,51
	SZKCY	29,68	36,51
	SZKCBW	40,81	50,20

RUMBA K

SUPER CENA

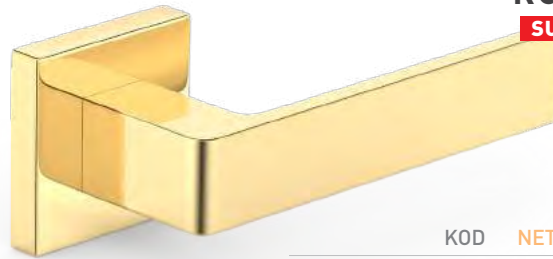

MOSIĄDZ
BŁYSZCZĄCY

	KOD	NETTO	BRUTTO
	VRUKMB	77,91	95,83
	SZKMBK	40,81	50,20
	SZKMBY	40,81	50,20
	SZKMBW	63,07	77,58

RUMBA K

SUPER CENA

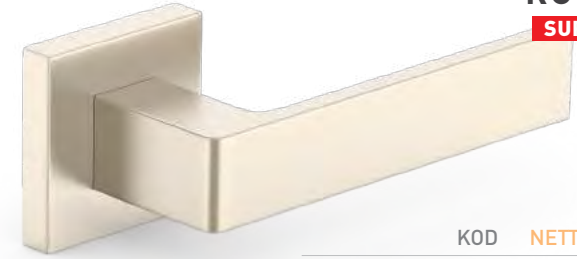

NIKIEL
SATYNA VELVET

	KOD	NETTO	BRUTTO
	VRUKNV	59,36	73,01
	SZKNVK	31,54	38,79
	SZKNVY	31,54	38,79
	SZKNVW	44,52	54,76

RUMBA K

SUPER CENA

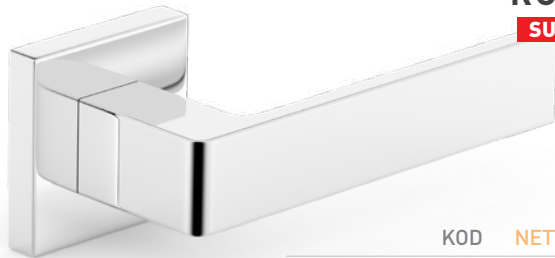

CHROM

	KOD	NETTO	BRUTTO
	VRUKCB	59,36	73,01
	SZKCBK	31,54	38,79
	SZKCBY	31,54	38,79
	SZKCBW	44,52	54,76

BARCELONA K

SUPER CENA

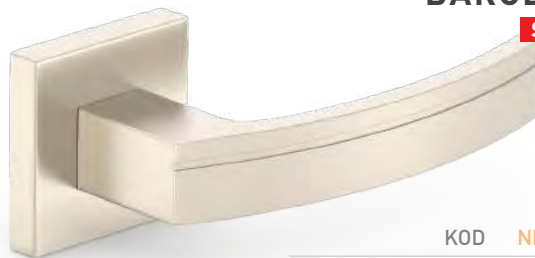

NIKIEL
SATYNA VELVET

	KOD	NETTO	BRUTTO
	VBAKNV	59,36	73,01
	SZKNVK	31,54	38,79
	SZKNVY	31,54	38,79
	SZKNVW	44,52	54,76

RIO K

SUPER CENA

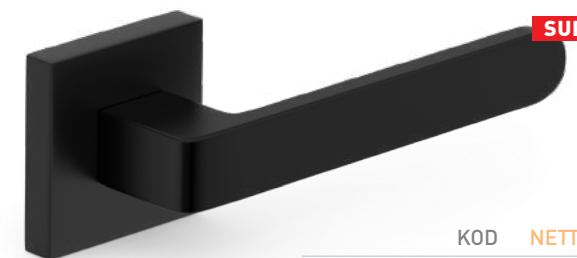

CZARNY

	KOD	NETTO	BRUTTO
	ZRIZCZK	55,65	68,45
	SZKCK	29,68	36,51
	SZKCY	29,68	36,51
	SZKCBW	40,81	50,20

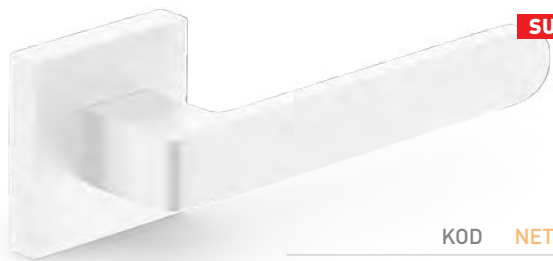

RIO K

SUPER CENA

	KOD	NETTO	BRUTTO
	ZRIZBIK	55,65	68,45
	SZKBK	29,68	36,51
	SZKBY	29,68	36,51
	SZKBW	40,81	50,20

BIAŁY

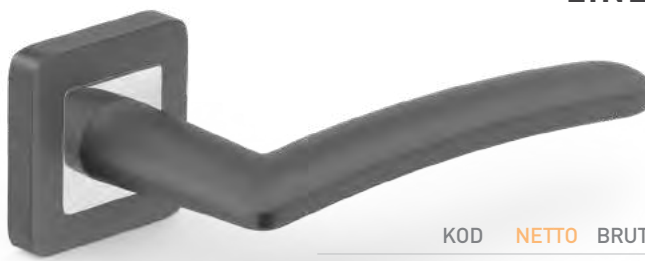

LINEA

	KOD	NETTO	BRUTTO
	ZLIZG	58,30	71,71
	SZZGK	24,60	30,26
	SZZGY	24,60	30,26
	SZZGW	35,90	44,16

GRAFIT/CHROM

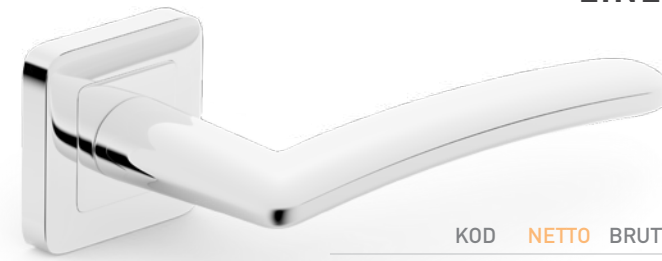

LINEA

	KOD	NETTO	BRUTTO
	ZLIZC	58,30	71,71
	SZZCK	22,57	27,76
	SZZCY	22,57	27,76
	SZZCW	33,87	41,66

CHROM



LINEA

	KOD	NETTO	BRUTTO
	ZLIZN	58,30	71,71
	SZZNK	22,57	27,76
	SZZNY	22,57	27,76
	SZZNW	33,87	41,66

NIKIEL/SATYNA



ISKRA

	KOD	NETTO	BRUTTO
	ZSLZC	58,30	71,71
	SZZCK	22,57	27,76
	SZZCY	22,57	27,76
	SZZCW	33,87	41,66

CHROM

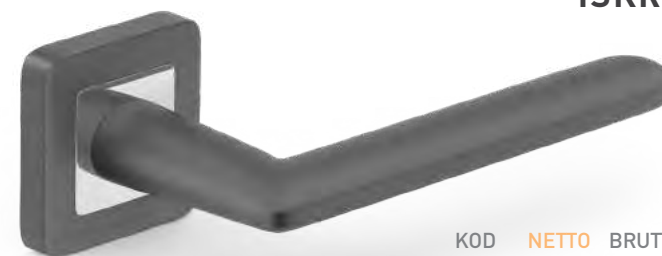

ISKRA

	KOD	NETTO	BRUTTO
	ZSLZG	58,30	71,71
	SZZGK	24,60	30,26
	SZZGY	24,60	30,26
	SZZGW	35,90	44,16

GRAFIT/CHROM



ISKRA

	KOD	NETTO	BRUTTO
	ZSLZN	58,30	71,71
	SZZNK	22,57	27,76
	SZZNY	22,57	27,76
	SZZNW	33,87	41,66

NIKIEL/SATYNA

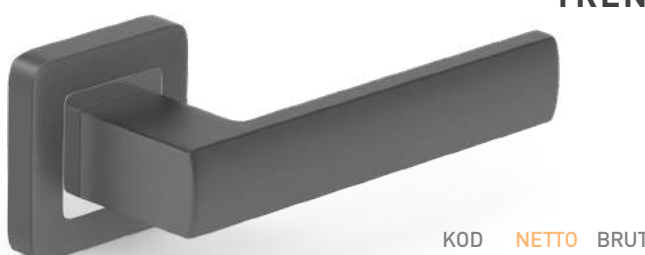

TREND

	KOD	NETTO	BRUTTO
	ZBRZG	58,30	71,71
	SZZGK	24,60	30,26
	SZZGY	24,60	30,26
	SZZGW	35,90	44,16

GRAFIT/CHROM



TREND

	KOD	NETTO	BRUTTO
	ZBRZC	58,30	71,71
	SZZCK	22,57	27,76
	SZZCY	22,57	27,76
	SZZCW	33,87	41,66

CHROM

DUO

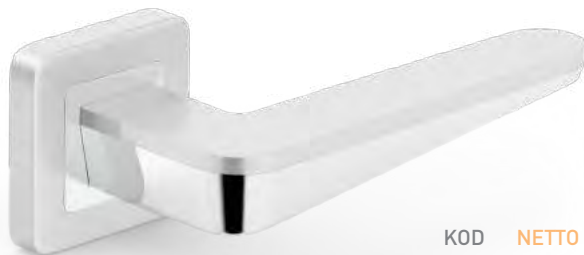

	KOD	NETTO	BRUTTO
	ZDUZN	77,73	95,61
	SZZSNK	22,57	27,76
	SZZSNY	22,57	27,76
	SZZSNW	33,87	41,66

NIKIEL/SATYNA

TREND

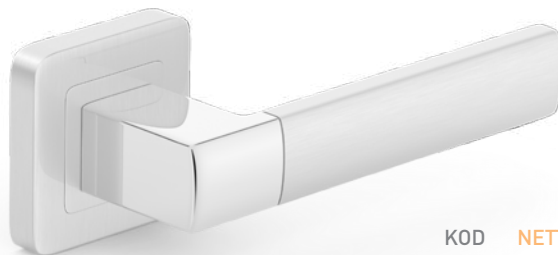

	KOD	NETTO	BRUTTO
	ZBRZN	58,30	71,71
	SZZNK	22,57	27,76
	SZZNY	22,57	27,76
	SZZNW	33,87	41,66

NIKIEL/SATYNA

DUO



	KOD	NETTO	BRUTTO
	ZDUZG	77,73	95,61
	SZZGK	24,60	30,26
	SZZGY	24,60	30,26
	SZZGW	35,90	44,16

GRAFIT/CHROM

IBIZA

SUPER CENA



	KOD	NETTO	BRUTTO
	ZIBZC	51,53	63,38
	SZZCK	22,57	27,76
	SZZCY	22,57	27,76
	SZZCW	33,87	41,66

CHROM

IBIZA



	KOD	NETTO	BRUTTO
	ZIBZG	57,87	71,18
	SZZGK	24,60	30,26
	SZZGY	24,60	30,26
	SZZGW	35,90	44,16

GRAFIT/CHROM

IBIZA

SUPER CENA

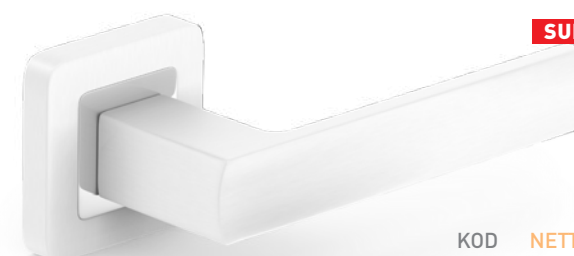

	KOD	NETTO	BRUTTO
	ZIBZS	66,37	81,64
	SZZSK	32,73	40,26
	SZZSY	32,73	40,26
	SZZSW	46,06	56,65

SREBRO SATYNOWANE

IBIZA

SUPER CENA

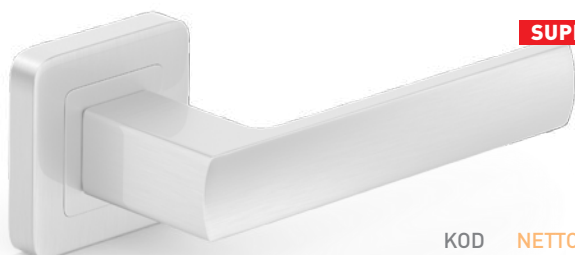

	KOD	NETTO	BRUTTO
	ZIBZN	51,53	63,38
	SZZNK	22,57	27,76
	SZZNY	22,57	27,76
	SZZNW	33,87	41,66

NIKIEL
SZCZOTKOWANY

IBIZA

SUPER CENA



	KOD	NETTO	BRUTTO
	ZIBZP	51,53	63,38
	SZZPK	22,57	27,76
	SZZPY	22,57	27,76
	SZZPW	33,87	41,66

PATYNA

RIO

SUPER CENA

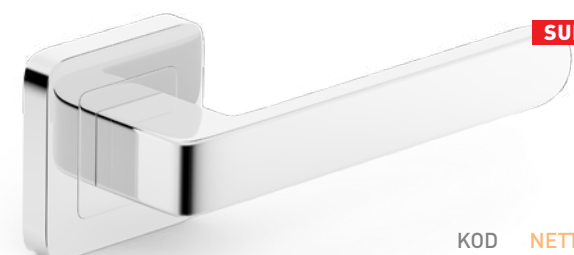

	KOD	NETTO	BRUTTO
	ZRIZC	51,53	63,38
	SZZCK	22,57	27,76
	SZZCY	22,57	27,76
	SZZCW	33,87	41,66

CHROM

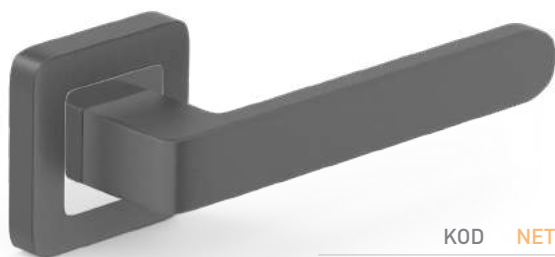

RIO

GRAFIT/CHROM

	KOD	NETTO	BRUTTO
	ZRIZG	57,87	71,18
	SZZGK	24,60	30,26
	SZZGY	24,60	30,26
	SZZGW	35,90	44,16

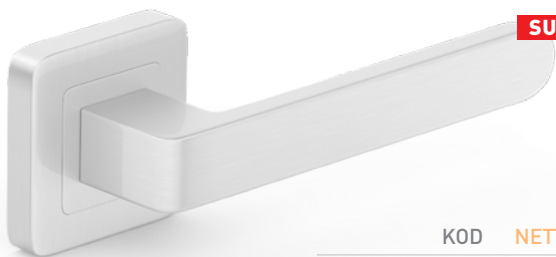

RIO

NIKIEL
SZCZOTKOWANY

SUPER CENA

	KOD	NETTO	BRUTTO
	ZRIZN	51,53	63,38
	SZZNK	22,57	27,76
	SZZNY	22,57	27,76
	SZZNW	33,87	41,66

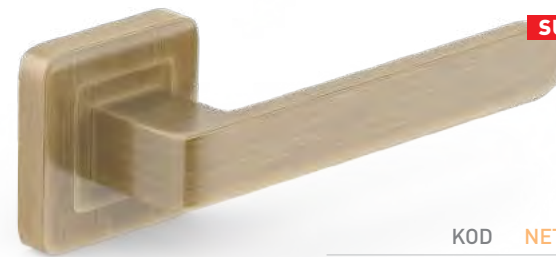

PATYNA

SUPER CENA

	KOD	NETTO	BRUTTO
	ZRIZP	51,53	63,38
	SZZPK	22,57	27,76
	SZZPY	22,57	27,76
	SZZPW	33,87	41,66

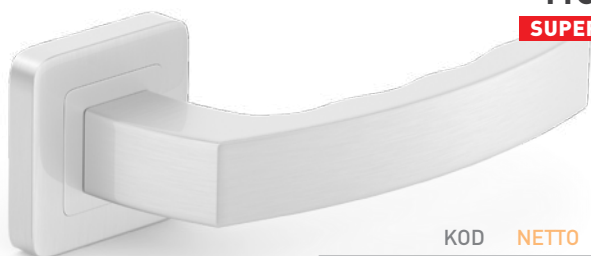

MONDO

NIKIEL
SZCZOTKOWANY

SUPER CENA

	KOD	NETTO	BRUTTO
	ZMOZN	51,53	63,38
	SZZNK	22,57	27,76
	SZZNY	22,57	27,76
	SZZNW	33,87	41,66



PATYNA

MONDO

SUPER CENA

	KOD	NETTO	BRUTTO
	ZMOZP	51,53	63,38
	SZZPK	22,57	27,76
	SZZPY	22,57	27,76
	SZZPW	33,87	41,66

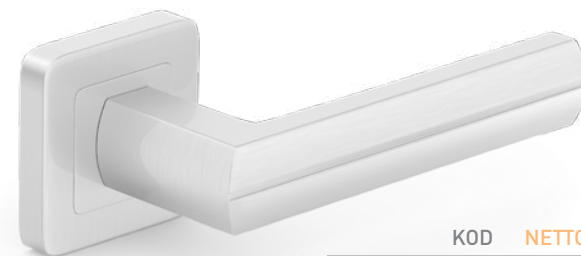

NIKIEL
SZCZOTKOWANY

VIVA

	KOD	NETTO	BRUTTO
	ZVIZN	53,99	66,40
	SZZNK	22,57	27,76
	SZZNY	22,57	27,76
	SZZNW	33,87	41,66



PATYNA

VIVA

	KOD	NETTO	BRUTTO
	ZVIZP	53,99	66,40
	SZZPK	22,57	27,76
	SZZPY	22,57	27,76
	SZZPW	33,87	41,66



NIKIEL
SZCZOTKOWANY

FIESTA

	KOD	NETTO	BRUTTO
	ZFIZN	47,50	58,42
	SZZNK	22,57	27,76
	SZZNY	22,57	27,76
	SZZNW	33,87	41,66



PATYNA

FIESTA

	KOD	NETTO	BRUTTO
	ZFIZP	47,50	58,42
	SZZPK	22,57	27,76
	SZZPY	22,57	27,76
	SZZPW	33,87	41,66

DARO

SUPER CENA



	KOD	NETTO	BRUTTO
	VDZN	51,53	63,38
	SZZNK	22,57	27,76
	SZZNY	22,57	27,76
	SZZNW	33,87	41,66

NIKIEL/SATYNA

DARO

SUPER CENA



	KOD	NETTO	BRUTTO
	VDZP	51,53	63,38
	SZZPK	22,57	27,76
	SZZPY	22,57	27,76
	SZZPW	33,87	41,66

PATYNA

PRIMA

SUPER CENA



	KOD	NETTO	BRUTTO
	ZPRZN	42,77	52,60
	SZZNK	22,57	27,76
	SZZNY	22,57	27,76
	SZZNW	33,87	41,66

NIKIEL/SATYNA

PRIMA

SUPER CENA



	KOD	NETTO	BRUTTO
	ZPRZP	42,77	52,60
	SZZPK	22,57	27,76
	SZZPY	22,57	27,76
	SZZPW	33,87	41,66

PATYNA

CAMILA

SUPER CENA



	KOD	NETTO	BRUTTO
	VCZN	43,75	53,82
	SZZNK	22,57	27,76
	SZZNY	22,57	27,76
	SZZNW	33,87	41,66

NIKIEL/SATYNA

CAMILA

SUPER CENA



	KOD	NETTO	BRUTTO
	VCZP	43,75	53,82
	SZZPK	22,57	27,76
	SZZPY	22,57	27,76
	SZZPW	33,87	41,66

PATYNA

GAŁKA

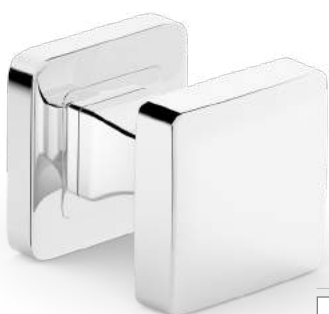

	KOD	NETTO	BRUTTO
	GKCHAS	38,87	47,81
	SZZCK	22,57	27,76
	SZZCY	22,57	27,76
	SZZCW	33,87	41,66

CHROM

Cena za 1 szt. w konfiguracji stałej lub obrotowej*



	KOD	NETTO	BRUTTO
	GKPAS	38,87	47,81
	SZZPK	22,57	27,76
	SZZPY	22,57	27,76
	SZZPW	33,87	41,66

PATYNA

Cena za 1 szt. w konfiguracji stałej lub obrotowej*

GAŁKA



	KOD	NETTO	BRUTTO
	GKSAS	38,87	47,81
	SZZNK	22,57	27,76
	SZZNY	22,57	27,76
	SZZNW	33,87	41,66

NIKIEL SZCZOTKOWANY

Cena za 1 szt. w konfiguracji stałej lub obrotowej*

* Pozostałe konfiguracje gatek; stałe, obrotowe oraz gałko-klamki dostępne na www.metal-bud.eu i na b2b.metal-bud.eu.



GAŁKA

GRAFIT/CHROM

Cena za 1 szt. w konfiguracji stałej lub obrotowej*

	KOD	NETTO	BRUTTO
	GKGAS	48,58	59,76
	SZZGK	24,60	30,26
	SZZGY	24,60	30,26
	SZZGW	35,90	44,16

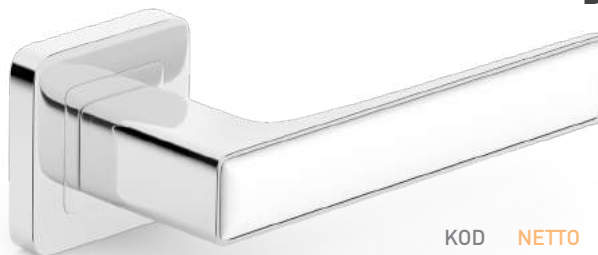

DECO

CHROM

DEKOR BIAŁY MAT*

	KOD	NETTO	BRUTTO
	DCPBI	111,30	136,90
	SZZCK	22,57	27,76
	SZZCY	22,57	27,76
	SZZCW	33,87	41,66



DECO

CHROM

DEKOR CZARNY
BŁYSZCZĄCY*

	KOD	NETTO	BRUTTO
	DCPCZB	111,30	136,90
	SZZCK	22,57	27,76
	SZZCY	22,57	27,76
	SZZCW	33,87	41,66



DECO

CHROM

DEKOR ŻŁOTY DĄB*

	KOD	NETTO	BRUTTO
	DCPDG	111,30	136,90
	SZZCK	22,57	27,76
	SZZCY	22,57	27,76
	SZZCW	33,87	41,66



DECO

CHROM

DEKOR ORZECH*

	KOD	NETTO	BRUTTO
	DCPOG	111,30	136,90
	SZZCK	22,57	27,76
	SZZCY	22,57	27,76
	SZZCW	33,87	41,66



DECO

CHROM

DEKOR DĄB SONOMA*

	KOD	NETTO	BRUTTO
	DCPDS	111,30	136,90
	SZZCK	22,57	27,76
	SZZCY	22,57	27,76
	SZZCW	33,87	41,66

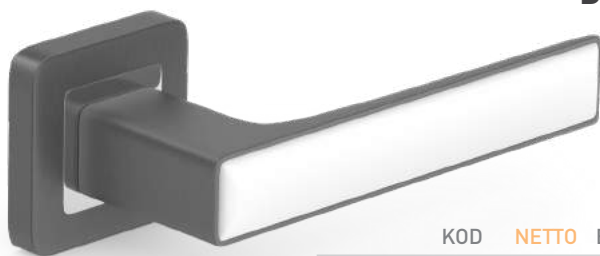

DECO

GRAFIT/CHROM

DEKOR BIAŁY MAT*

	KOD	NETTO	BRUTTO
	DGPBI	111,30	136,90
	SZZGK	24,60	30,26
	SZZGY	24,60	30,26
	SZZGW	35,90	44,16



DECO

GRAFIT/CHROM

DEKOR CZARNY
BŁYSZCZĄCY*

	KOD	NETTO	BRUTTO
	DGPCZB	111,30	136,90
	SZZGK	24,60	30,26
	SZZGY	24,60	30,26
	SZZGW	35,90	44,16



DECO

GRAFIT/CHROM

DEKOR ŻŁOTY DĄB*

	KOD	NETTO	BRUTTO
	DGPDG	111,30	136,90
	SZZGK	24,60	30,26
	SZZGY	24,60	30,26
	SZZGW	35,90	44,16

* Inne kolory dekorów do klamki DECO dostępne na www.metal-bud.eu i na b2b.metal-bud.eu.

DECO



GRAFIT/CHROM
DEKOR ORZECH*

	KOD	NETTO	BRUTTO
	DGPDSG	111,30	136,90
	SZZGK	24,60	30,26
	SZZGY	24,60	30,26
	SZZGW	35,90	44,16

DECO



GRAFIT/CHROM
DEKOR DĄB SONOMA*

	KOD	NETTO	BRUTTO
	DGPDS	111,30	136,90
	SZZGK	24,60	30,26
	SZZGY	24,60	30,26
	SZZGW	35,90	44,16

DECO

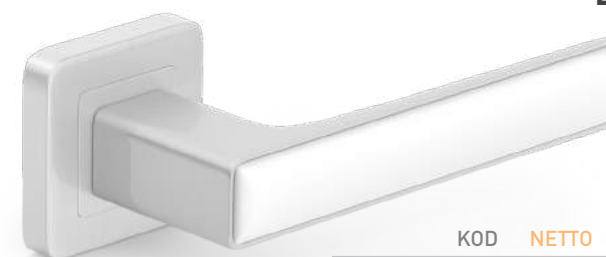

NIKIEL
SZCZOTKOWANY
DEKOR BIAŁY*

	KOD	NETTO	BRUTTO
	DNPBI	111,30	136,90
	SZZNK	22,57	27,76
	SZZNY	22,57	27,76
	SZZNW	33,87	41,66

DECO

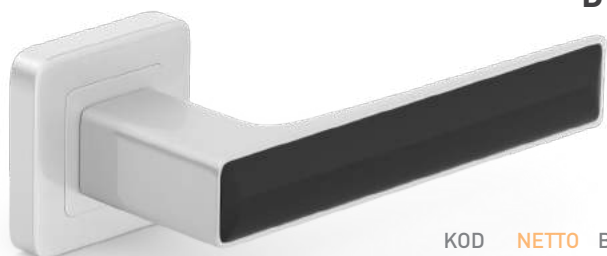

NIKIEL
SZCZOTKOWANY
DEKOR CZARNY*

	KOD	NETTO	BRUTTO
	DNPCZB	111,30	136,90
	SZZNK	22,57	27,76
	SZZNY	22,57	27,76
	SZZNW	33,87	41,66

DECO



NIKIEL
SZCZOTKOWANY
DEKOR ŻŁOTY DĄB*

	KOD	NETTO	BRUTTO
	DNPDG	111,30	136,90
	SZZNK	22,57	27,76
	SZZNY	22,57	27,76
	SZZNW	33,87	41,66

DECO



NIKIEL
SZCZOTKOWANY
DEKOR ORZECH*

	KOD	NETTO	BRUTTO
	DNPOG	111,30	136,90
	SZZNK	22,57	27,76
	SZZNY	22,57	27,76
	SZZNW	33,87	41,66

DECO



NIKIEL
SZCZOTKOWANY
DEKOR DĄB SONOMA*

	KOD	NETTO	BRUTTO
	DNPDS	111,30	136,90
	SZZNK	22,57	27,76
	SZZNY	22,57	27,76
	SZZNW	33,87	41,66

DECO



CHROM
DEKOR
CZARNE KRYSTAŁKI

	KOD	NETTO	BRUTTO
	DCGCZ	116,60	143,42
	SZZCK	22,57	27,76
	SZZCY	22,57	27,76
	SZZCW	33,87	41,66

DECO GLAMOUR



CHROM
DEKOR
SREBRNE KRYSTAŁKI

	KOD	NETTO	BRUTTO
	DCGSR	116,60	143,42
	SZZCK	22,57	27,76
	SZZCY	22,57	27,76
	SZZCW	33,87	41,66

* Inne kolory dekorów do klamki DECO dostępne na www.metal-bud.eu i na b2b.metal-bud.eu.

DECO GLAMOUR



GRAFIT/CHROM
DEKOR
CZARNE KRYSTAŁKI

	KOD	NETTO	BRUTTO
	DGGCZ	116,60	143,42
	SZZGK	24,60	30,26
	SZZGY	24,60	30,26
	SZZGW	35,90	44,16

DECO GLAMOUR



GRAFIT/CHROM
DEKOR
SREBRNE KRYSTAŁKI

	KOD	NETTO	BRUTTO
	DGGSR	116,60	143,42
	SZZGK	24,60	30,26
	SZZGY	24,60	30,26
	SZZGW	35,90	44,16

DECO GLAMOUR



NIKIEL SZCZOTKOWANY
DEKOR
SREBRNE KRYSTAŁKI

	KOD	NETTO	BRUTTO
	DNGSR	116,60	143,42
	SZZNK	22,57	27,76
	SZZNY	22,57	27,76
	SZZNW	33,87	41,66

DECO GLAMOUR



NIKIEL SZCZOTKOWANY
DEKOR
CZARNE KRYSTAŁKI

	KOD	NETTO	BRUTTO
	DNGCZ	116,60	143,42
	SZZNK	22,57	27,76
	SZZNY	22,57	27,76
	SZZNW	33,87	41,66

EUROPA

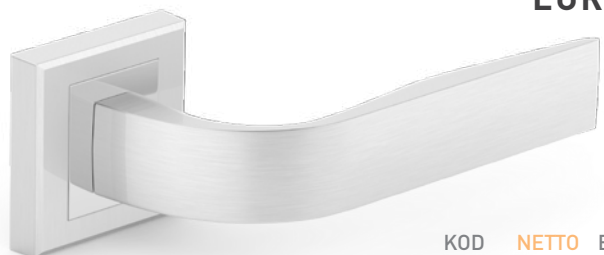

NIKIEL/SATYNA

	KOD	NETTO	BRUTTO
	ZEKN	49,50	60,89
	SZKNK	20,32	24,99
	SZKNY	20,32	24,99
	SZKNW	30,48	37,48

ALFA

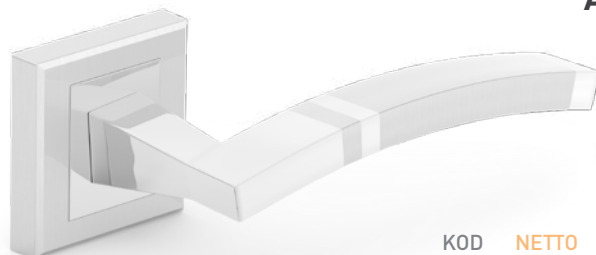

NIKIEL/SATYNA

	KOD	NETTO	BRUTTO
	ZAKN	55,00	67,65
	SZKNK	20,32	24,99
	SZKNY	20,32	24,99
	SZKNW	30,48	37,48

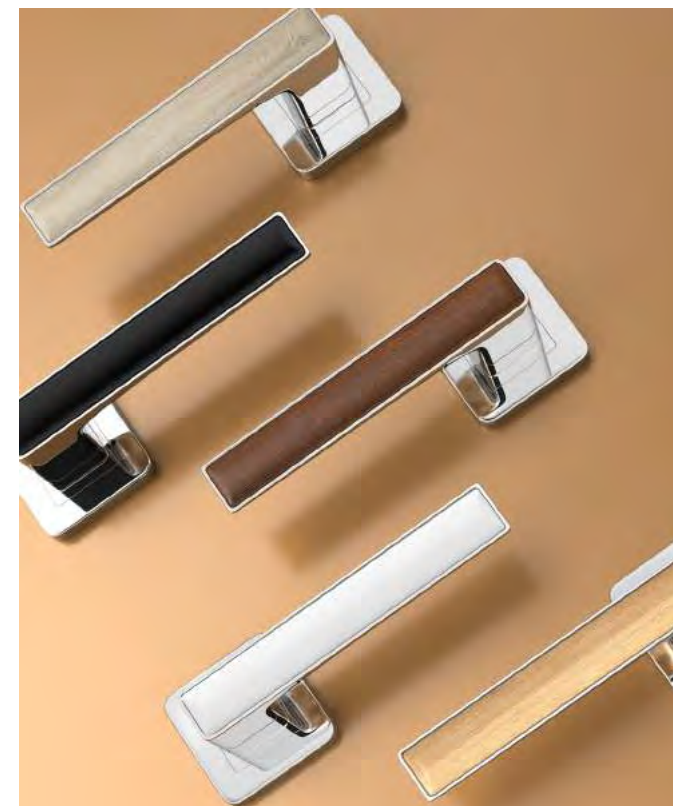

DECO

DOPASUJ KLAMKĘ
DO SWOJEGO
WNĘTRZA

PLEJADA



	KOD	NETTO	BRUTTO
	VPKN	45,84	56,38
	SZKNK	20,32	24,99
	SZKNY	20,32	24,99
	SZKNW	30,48	37,48

NIKIEL/SATYNA

PLEJADA



	KOD	NETTO	BRUTTO
	VPKP	45,84	56,38
	SZKPK	20,32	24,99
	SZKPY	20,32	24,99
	SZKPW	30,48	37,48

PATYNA

BETA

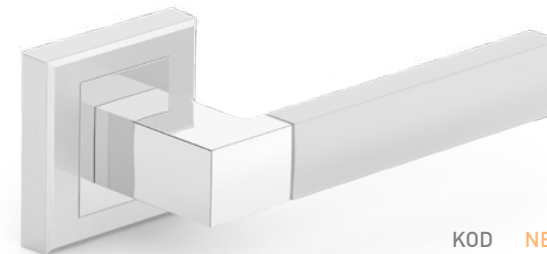

	KOD	NETTO	BRUTTO
	ZBKN	51,34	63,14
	SZKNK	20,32	24,99
	SZKNY	20,32	24,99
	SZKNW	30,48	37,48

NIKIEL/SATYNA

BETA

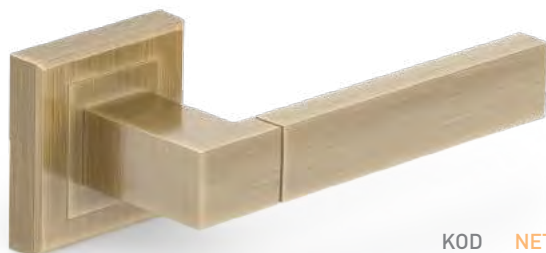

	KOD	NETTO	BRUTTO
	ZBKP	51,34	63,14
	SZKPK	20,32	24,99
	SZKPY	20,32	24,99
	SZKPW	30,48	37,48

PATYNA

ASTRA

SUPER CENA

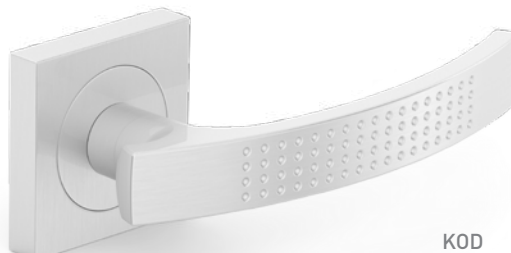

	KOD	NETTO	BRUTTO
	VAKN	36,66	45,10
	VSKNK	17,27	21,24
	VSKNY	17,27	21,24
	VSKNW	28,44	34,99

NIKIEL
SZCZOTKOWANY

ASTRA

SUPER CENA

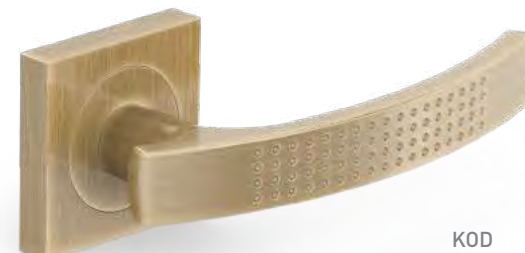

	KOD	NETTO	BRUTTO
	VAKP	36,66	45,10
	VSKPK	17,27	21,24
	VSKPY	17,27	21,24
	VSKPW	28,44	34,99

PATYNA

QUBIK

SUPER CENA

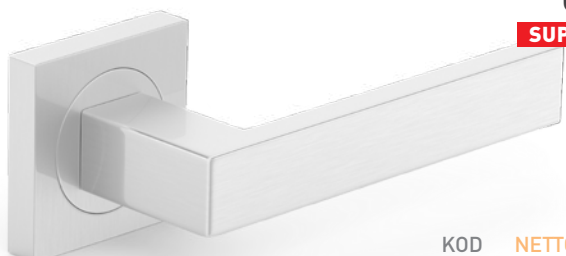

	KOD	NETTO	BRUTTO
	VQKN	40,34	49,61
	VSKNK	17,27	21,24
	VSKNY	17,27	21,24
	VSKNW	28,44	34,99

NIKIEL
SZCZOTKOWANY

QUBIK

SUPER CENA



	KOD	NETTO	BRUTTO
	VQKP	40,34	49,61
	VSKPK	17,27	21,24
	VSKPY	17,27	21,24
	VSKPW	28,44	34,99

PATYNA

CAMILA



	KOD	NETTO	BRUTTO
	VCOCZ	48,58	59,76
	SZOCK	24,73	30,42
	SZOCY	24,73	30,42
	SZOCW	35,33	43,46

CZARNY

ASTRA

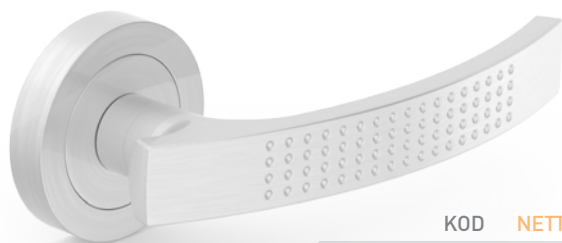

NIKIEL
SZCZOTKOWANY

	KOD	NETTO	BRUTTO
	VAON	34,98	43,03
	SNOSK	14,22	17,49
	SNOSY	14,22	17,49
	SNOSW	24,38	29,99

ASTRA



CZARNY

	KOD	NETTO	BRUTTO
	VAOCZ	34,98	43,03
	SNOCZK	14,22	17,49
	SNOCZY	14,22	17,49
	SNOCZW	24,38	29,99

ASTRA



CHROM

	KOD	NETTO	BRUTTO
	VAOC	34,98	43,03
	SNOCHK	14,22	17,49
	SNOCHY	14,22	17,49
	SNOCHW	24,38	29,99

ASTRA



PATYNA

	KOD	NETTO	BRUTTO
	VAOP	34,98	43,03
	SNOPK	14,22	17,49
	SNOPY	14,22	17,49
	SNOPW	24,38	29,99

SYDNEY

SUPER CENA

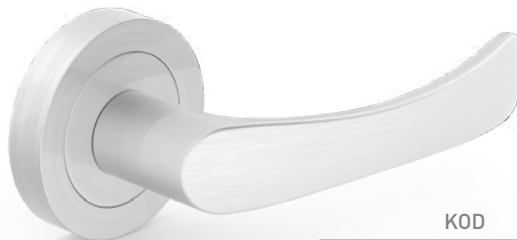

NIKIEL
SZCZOTKOWANY

	KOD	NETTO	BRUTTO
	VSON	36,66	45,10
	SNOSK	14,22	17,49
	SNOSY	14,22	17,49
	SNOSW	24,38	29,99

SYDNEY

SUPER CENA



PATYNA

	KOD	NETTO	BRUTTO
	VSOP	36,66	45,10
	SNOPK	14,22	17,49
	SNOPY	14,22	17,49
	SNOPW	24,38	29,99

LIBRA

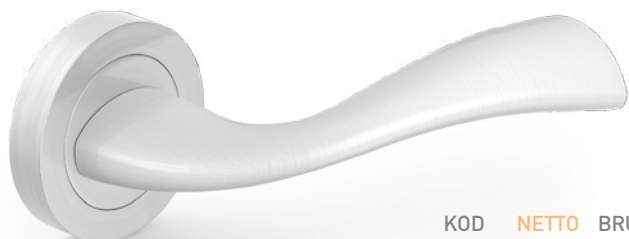

NIKIEL
SZCZOTKOWANY

	KOD	NETTO	BRUTTO
	ZLON	38,87	47,81
	SNOSK	14,22	17,49
	SNOSY	14,22	17,49
	SNOSW	24,38	29,99

LIBRA



PATYNA

	KOD	NETTO	BRUTTO
	ZLOP	38,87	47,81
	SNOPK	14,22	17,49
	SNOPY	14,22	17,49
	SNOPW	24,38	29,99

BLANKA



CHROM/SATYNA

	KOD	NETTO	BRUTTO
	VBOC	38,87	47,81
	TNOCK	14,22	17,49
	TNOCY	14,22	17,49
	TNOCW	24,38	29,99

ZORBA

SUPER CENA



	KOD	NETTO	BRUTTO
	VZOC	33,04	40,64
	TNOCK	14,22	17,49
	TNOCY	14,22	17,49
	TNOCW	24,38	29,99

CHROM/SATYNA

ZORBA

SUPER CENA



	KOD	NETTO	BRUTTO
	VZOP	33,04	40,64
	SNOPK	14,22	17,49
	SNOPY	14,22	17,49
	SNOPW	24,38	29,99

PATYNA

DIANA



	KOD	NETTO	BRUTTO
	ZDON	38,87	47,81
	SNOSK	14,22	17,49
	SNOSY	14,22	17,49
	SNOSW	24,38	29,99

NIKIEL
SZCZOTKOWANY

DIANA



	KOD	NETTO	BRUTTO
	ZDOP	38,87	47,81
	SNOPK	14,22	17,49
	SNOPY	14,22	17,49
	SNOPW	24,38	29,99

PATYNA

DARO

SUPER CENA



	KOD	NETTO	BRUTTO
	VDOC	42,67	52,48
	TNOCK	14,22	17,49
	TNOCY	14,22	17,49
	TNOCW	24,38	29,99

CHROM/SATYNA

DARO

SUPER CENA



	KOD	NETTO	BRUTTO
	VDOP	42,67	52,48
	SNOPK	14,22	17,49
	SNOPY	14,22	17,49
	SNOPW	24,38	29,99

PATYNA

PLEJADA



	KOD	NETTO	BRUTTO
	VPOC	44,70	54,98
	TNOCK	14,22	17,49
	TNOCY	14,22	17,49
	TNOCW	24,38	29,99

CHROM/SATYNA

PLEJADA



	KOD	NETTO	BRUTTO
	VPOP	44,70	54,98
	SNOPK	14,22	17,49
	SNOPY	14,22	17,49
	SNOPW	24,38	29,99

PATYNA

NICOLE

SUPER CENA

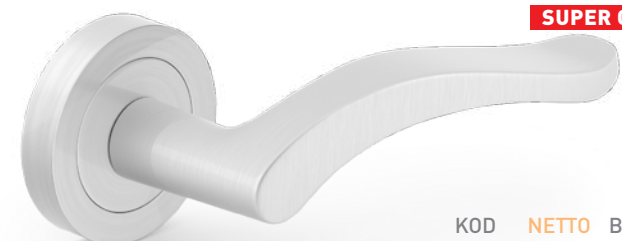

	KOD	NETTO	BRUTTO
	VNON	34,98	43,03
	SNOSK	14,22	17,49
	SNOSY	14,22	17,49
	SNOSW	24,38	29,99

NIKIEL
SZCZOTKOWANY



NICOLE SUPER CENA

	KOD	NETTO	BRUTTO
	VNOP	34,98	43,03
	SNOPK	14,22	17,49
	SNOPY	14,22	17,49
	SNOPW	24,38	29,99

PATYNA

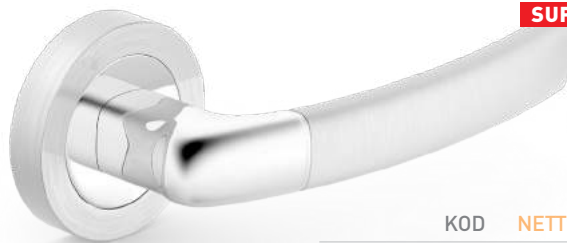

CAMILA SUPER CENA

	KOD	NETTO	BRUTTO
	VCOC	42,67	52,48
	TNOCK	14,22	17,49
	TNOCY	14,22	17,49
	TNOCW	24,38	29,99

CHROM/SATYNA



CAMILA SUPER CENA

	KOD	NETTO	BRUTTO
	VCOP	42,67	52,48
	SNOPK	14,22	17,49
	SNOPY	14,22	17,49
	SNOPW	24,38	29,99

PATYNA

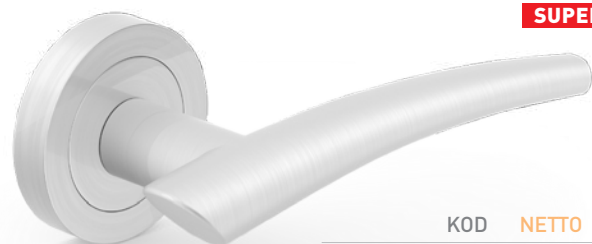

IDEA SUPER CENA

	KOD	NETTO	BRUTTO
	ZION	29,68	36,51
	SNOSK	14,22	17,49
	SNOSY	14,22	17,49
	SNOSW	24,38	29,99

NIKIEL
SZCZOTKOWANY



IDEA SUPER CENA

	KOD	NETTO	BRUTTO
	ZIOP	29,68	36,51
	SNOPK	14,22	17,49
	SNOPY	14,22	17,49
	SNOPW	24,38	29,99

PATYNA



RICCO SUPER CENA

	KOD	NETTO	BRUTTO
	ZRON	44,52	54,76
	SNOSK	14,22	17,49
	SNOSY	14,22	17,49
	SNOSW	24,38	29,99

NIKIEL
SZCZOTKOWANY



ARTEMIDA

	KOD	NETTO	BRUTTO
	AROP	54,41	66,93
	SNOPK	14,22	17,49
	SNOPY	14,22	17,49
	SNOPW	24,38	29,99

PATYNA



FEBE SUPER CENA

	KOD	NETTO	BRUTTO
	VFON	27,83	34,22
	SNOSK	14,22	17,49
	SNOSY	14,22	17,49
	SNOSW	24,38	29,99

NIKIEL
SZCZOTKOWANY



ORION SUPER CENA

	KOD	NETTO	BRUTTO
	ZOOP	45,45	55,90
	SNOPK	14,22	17,49
	SNOPY	14,22	17,49
	SNOPW	24,38	29,99

PATYNA

OKRAGLE

EVA

SUPER CENA



	KOD	NETTO	BRUTTO
	VEOC	42,67	52,48
	TNOCK	14,22	17,49
	TNOCY	14,22	17,49
	TNOCW	24,38	29,99

CHROM/SATYNA

TOSCA



	KOD	NETTO	BRUTTO
	ZTONA	75,79	93,22
	SNONAK	34,54	42,48
	SNONAY	34,54	42,48
	SNONAW	58,92	72,47

NIKIEL ANTYCZNY

TOSCA



	KOD	NETTO	BRUTTO
	ZTOPA	67,05	82,47
	SNOPAK	28,44	34,99
	SNOPAY	28,44	34,99
	SNOPAW	50,79	62,47

PATYNA ANTYCZNA

CHIARA



	KOD	NETTO	BRUTTO
	ZCONA	75,79	93,22
	SNONAK	34,54	42,48
	SNONAY	34,54	42,48
	SNONAW	58,92	72,47

NIKIEL ANTYCZNY

CHIARA



	KOD	NETTO	BRUTTO
	ZCOPA	67,05	82,47
	SNOPAK	28,44	34,99
	SNOPAY	28,44	34,99
	SNOPAW	50,79	62,47

PATYNA ANTYCZNA

GAŁKA



	KOD	NETTO	BRUTTO
	GZNSZ	38,87	47,81
	SNOSK	14,22	17,49
	SNOSY	14,22	17,49
	SNOSW	24,38	29,99

NIKIEL

SZCZOTKOWANY

Cena za 1 szt. w konfiguracji stałej lub obrotowej*

GAŁKA



	KOD	NETTO	BRUTTO
	GZPAT	38,87	47,81
	SNOPK	14,22	17,49
	SNOPY	14,22	17,49
	SNOPW	24,38	29,99

PATYNA

Cena za 1 szt. w konfiguracji stałej lub obrotowej*

GAŁKA CRYSTAL



	KOD	NETTO	BRUTTO
	GOCCOC	174,90	215,13
	SNOCHK	14,22	17,49
	SNOCHY	14,22	17,49
	SNOCHW	24,38	29,99

CZARNY/CHROM

Dostępne wyłącznie jako komplet obrotowy.

GAŁKA CRYSTAL



	KOD	NETTO	BRUTTO
	GOCPQC	155,47	191,22
	SNOCHK	14,22	17,49
	SNOCHY	14,22	17,49
	SNOCHW	24,38	29,99

CHROM

PRZEZROCZYSTY

Dostępne wyłącznie jako komplet obrotowy.



TOPAZ

SUPER CENA

	KOD	NETTO	BRUTTO
	STKMBI	80,49	99,00
	SSKKMB	28,18	34,66
	SSKYMB	28,18	34,66
	SSKWMB	53,00	65,19

BIAŁY



TOPAZ

SUPER CENA

	KOD	NETTO	BRUTTO
	STKMCZ	80,49	99,00
	SSKKMC	31,09	38,24
	SSKYMC	31,09	38,24
	SSKWMC	58,30	71,71

CZARNY

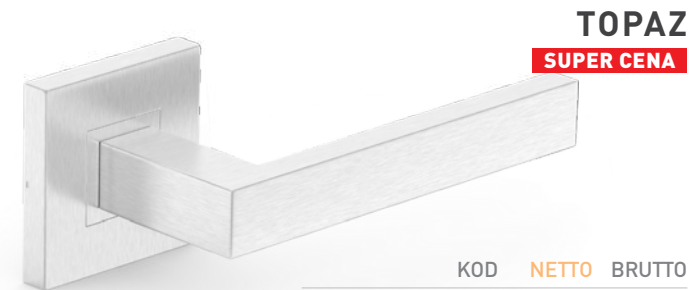

TOPAZ

SUPER CENA

	KOD	NETTO	BRUTTO
	STK	40,34	49,61
	SSKK	15,26	18,77
	SSKY	15,26	18,77
	SSKW	31,48	38,72

STAL NIERDZEWNA



TOPAZ 3S

	KOD	NETTO	BRUTTO
	STKC3S	126,32	155,37
	SSKKC3S	58,30	71,71
	SSKYC3S	58,30	71,71
	SSKW3S	77,73	95,61

CZARNY

GRUBOŚĆ ROZETY: 3 mm

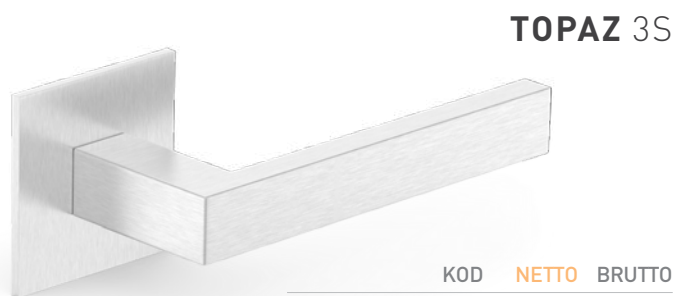

TOPAZ 3S

	KOD	NETTO	BRUTTO
	STK3S	106,88	131,47
	SSKK3S	48,58	59,76
	SSKY3S	48,58	59,76
	SSKW3S	68,02	83,66

STAL NIERDZEWNA

GRUBOŚĆ ROZETY: 3 mm

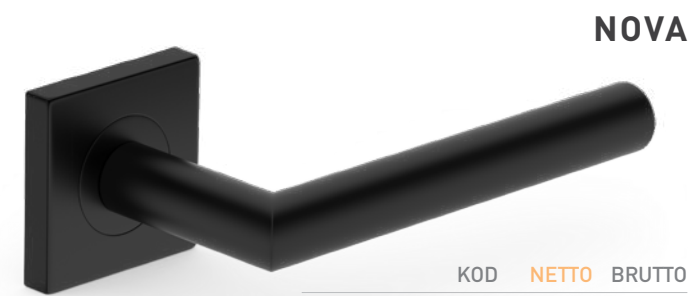

NOVA

	KOD	NETTO	BRUTTO
	NOVKCZ	62,19	76,49
	SSKKMC	31,09	38,24
	SSKYMC	31,09	38,24
	SSKWMC	58,30	71,71

CZARNY



NOVA

SUPER CENA

F

	KOD	NETTO	BRUTTO
	NOVK	42,75	52,59
	SSKK	15,26	18,77
	SSKY	15,26	18,77
	SSKW	31,48	38,72

STAL NIERDZEWNA

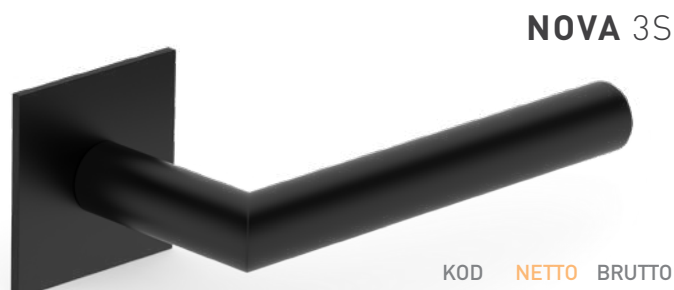

NOVA 3S

	KOD	NETTO	BRUTTO
	NOVKC3S	126,32	155,37
	SSKKC3S	58,30	71,71
	SSKYC3S	58,30	71,71
	SSKW3S	77,73	95,61

CZARNY

GRUBOŚĆ ROZETY: 3 mm

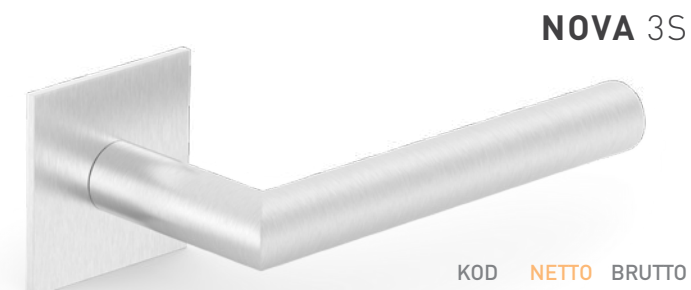

NOVA 3S

	KOD	NETTO	BRUTTO
	NOVK3S	106,88	131,47
	SSKK3S	48,58	59,76
	SSKY3S	48,58	59,76
	SSKW3S	68,02	83,66

STAL NIERDZEWNA

GRUBOŚĆ ROZETY: 3 mm

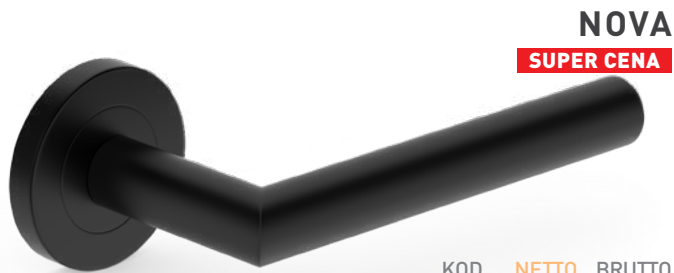

NOVA
SUPER CENA

	KOD	NETTO	BRUTTO
	NOVOCZ	58,66	72,16
	NNKPC	21,20	26,08
	NNYPC	21,20	26,08
	NNWPC	45,93	56,50

CZARNY



NOVA
SUPER CENA

F

	KOD	NETTO	BRUTTO
	NOVO	29,34	36,08
	NNK	10,60	13,04
	NNY	10,60	13,04
	NNWC	24,80	30,51

STAL NIERDZEWNA

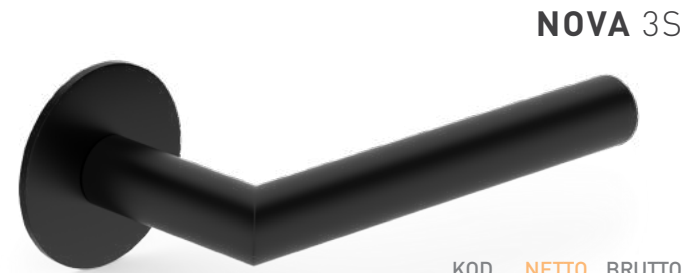

NOVA 3S

	KOD	NETTO	BRUTTO
	NOVOC3S	106,88	131,47
	NNKC3S	48,58	59,76
	NNYC3S	48,58	59,76
	NNWC3S	68,02	83,66

CZARNY

GRUBOŚĆ ROZETY: 3 mm



NOVA 3S

	KOD	NETTO	BRUTTO
	NOVO3S	87,45	107,56
	NNK3S	38,87	47,81
	NNY3S	38,87	47,81
	NNWC3S	58,30	71,71

STAL NIERDZEWNA

GRUBOŚĆ ROZETY: 3 mm



METRO
SUPER CENA

	KOD	NETTO	BRUTTO
	MTRKCZ	102,66	126,28
	SSKKMC	31,09	38,24
	SSKYMC	31,09	38,24
	SSKWMC	58,30	71,71

CZARNY



METRO
SUPER CENA

	KOD	NETTO	BRUTTO
	METRK	51,34	63,14
	SSKK	15,26	18,77
	SSKY	15,26	18,77
	SSKW	31,48	38,72

STAL NIERDZEWNA



METRO
SUPER CENA

	KOD	NETTO	BRUTTO
	MTROCZ	102,66	126,28
	NNKPC	21,20	26,08
	NNYPC	21,20	26,08
	NNWPC	45,93	56,50

CZARNY



METRO
SUPER CENA

	KOD	NETTO	BRUTTO
	METRO	51,34	63,14
	NNK	10,60	13,04
	NNY	10,60	13,04
	NNWC	24,80	30,51

STAL NIERDZEWNA



GAŁKA

	KOD	NETTO	BRUTTO
	SGKPCZ	77,74	95,61
	SSKKMC	31,09	38,24
	SSKYMC	31,09	38,24
	SSKWMC	58,30	71,71

CZARNY

Cena za 1 szt. w konfiguracji stałej lub obrotowej*

INOX

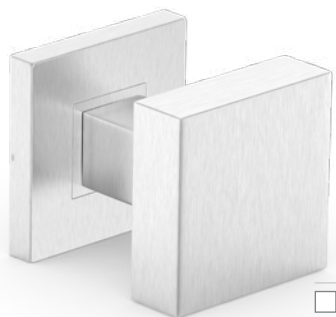

GAŁKA

STAL NIERDZEWNA

Cena za 1 szt. w konfiguracji stałej lub obrotowej*

	KOD	NETTO	BRUTTO
□	SGK	38,87	47,81
□	SSKK	15,26	18,77
⊖	SSKY	15,26	18,77
WC	SSKW	31,48	38,72

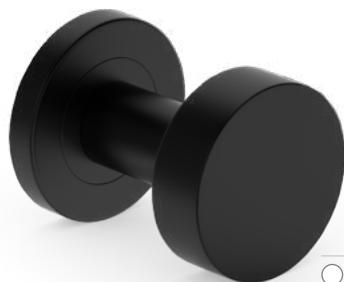

GAŁKA

CZARNY

Cena za komplet w konfiguracji stałej lub obrotowej*

	KOD	NETTO	BRUTTO
○	SGOOCZ	155,47	191,22
⊖	NNKPC	21,20	26,08
⊖	NNYPC	21,20	26,08
WC	NNWPC	45,93	56,50



GAŁKA

STAL NIERDZEWNA

Cena za komplet w konfiguracji stałej lub obrotowej*

	KOD	NETTO	BRUTTO
○	SG00	97,17	119,52
⊖	NNK	10,60	13,04
⊖	NNY	10,60	13,04
WC	NNWC	24,80	30,51

F

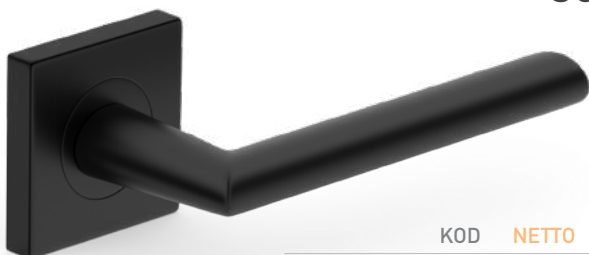

SUPRA

CZARNY

	KOD	NETTO	BRUTTO
☞	SUNKCZ	88,62	109,00
□	SSKKMC	31,09	38,24
⊖	SSKYMC	31,09	38,24
WC	SSKWMC	58,30	71,71

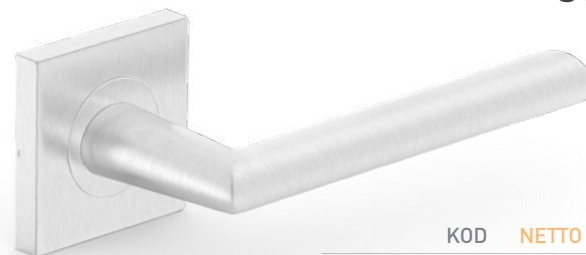

SUPRA

STAL NIERDZEWNA

	KOD	NETTO	BRUTTO
☞	SUNK	66,08	81,27
□	SSKK	15,26	18,77
⊖	SSKY	15,26	18,77
WC	SSKW	31,48	38,72

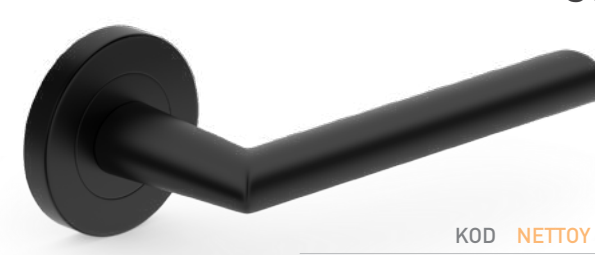

SUPRA

CZARNY

	KOD	NETTO	BRUTTO
☞	SUNOCZ	80,49	99,00
⊖	NNKPC	21,20	26,08
⊖	NNYPC	21,20	26,08
WC	NNWPC	45,93	56,50



SUPRA

STAL NIERDZEWNA

	KOD	NETTO	BRUTTO
☞	SUNO	58,30	71,71
⊖	NNK	10,60	13,04
⊖	NNY	10,60	13,04
WC	NNWC	24,80	30,51



SAPPHIRE

CZARNY

	KOD	NETTO	BRUTTO
☞	SNOKCZ	93,28	114,73
□	SSKKMC	31,09	38,24
⊖	SSKYMC	31,09	38,24
WC	SSKWMC	58,30	71,71

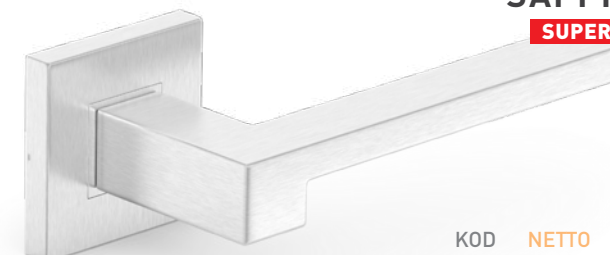

SAPPHIRE

SUPER CENA

STAL NIERDZEWNA

	KOD	NETTO	BRUTTO
☞	SNOK	50,53	62,15
□	SSKK	15,26	18,77
⊖	SSKY	15,26	18,77
WC	SSKW	31,48	38,72

* Pozostałe konfiguracje gatek; stałe, obrotowe oraz gałko-klamki dostępne na www.metal-bud.eu i na b2b.metal-bud.eu.

F Istnieje możliwość zastosowania przy stolarnie ognioodpornej, szczegółowe informacje dostępne na www.metal-bud.eu.



ONYX

	KOD	NETTO	BRUTTO
	SOK	51,50	63,34
	SSKK	15,26	18,77
	SSKY	15,26	18,77
	SSKW	31,48	38,72

STAL NIERDZEWNA

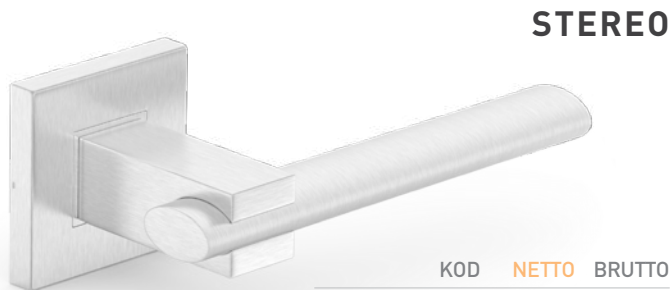

STEREO

	KOD	NETTO	BRUTTO
	STER	54,41	66,93
	SSKK	15,26	18,77
	SSKY	15,26	18,77
	SSKW	31,48	38,72

STAL NIERDZEWNA



ROMA



	KOD	NETTO	BRUTTO
	RNOK	66,07	81,27
	SSKK	15,26	18,77
	SSKY	15,26	18,77
	SSKW	31,48	38,72

STAL NIERDZEWNA



ROMA



	KOD	NETTO	BRUTTO
	RNO	58,30	71,71
	NNK	10,60	13,04
	NNY	10,60	13,04
	NNWC	24,80	30,51

STAL NIERDZEWNA



BOLD



	KOD	NETTO	BRUTTO
	BNOK	66,07	81,27
	SSKK	15,26	18,77
	SSKY	15,26	18,77
	SSKW	31,48	38,72

STAL NIERDZEWNA



BOLD



	KOD	NETTO	BRUTTO
	BNO	58,30	71,71
	NNK	10,60	13,04
	NNY	10,60	13,04
	NNWC	24,80	30,51

STAL NIERDZEWNA



AGAT

	KOD	NETTO	BRUTTO
	ANOK	58,30	71,71
	SSKK	15,26	18,77
	SSKY	15,26	18,77
	SSKW	31,48	38,72

STAL NIERDZEWNA



AGAT

	KOD	NETTO	BRUTTO
	ANO	50,53	62,15
	NNK	10,60	13,04
	NNY	10,60	13,04
	NNWC	24,80	30,51

STAL NIERDZEWNA

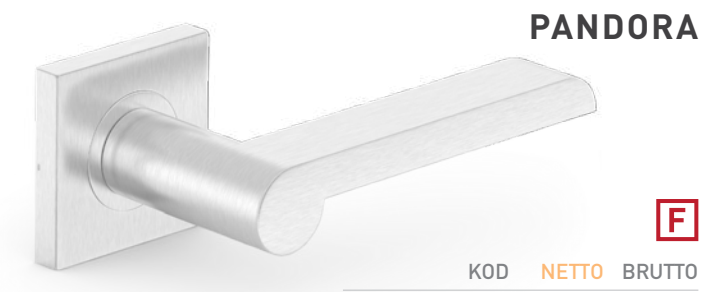

PANDORA



	KOD	NETTO	BRUTTO
	PANK	66,08	81,27
	SSKK	15,26	18,77
	SSKY	15,26	18,77
	SSKW	31,48	38,72

STAL NIERDZEWNA

PANDORA

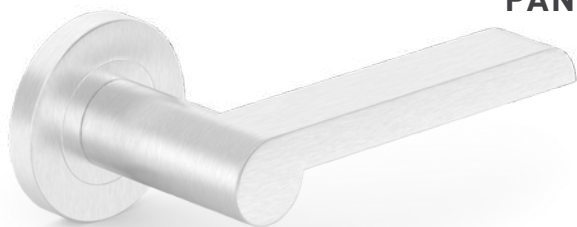

	KOD	NETTO	BRUTTO
	PANO	58,30	71,71
	NNK	10,60	13,04
	NNY	10,60	13,04
	NNWC	24,80	30,51

STAL NIERDZEWNA

LEDA

SUPER CENA

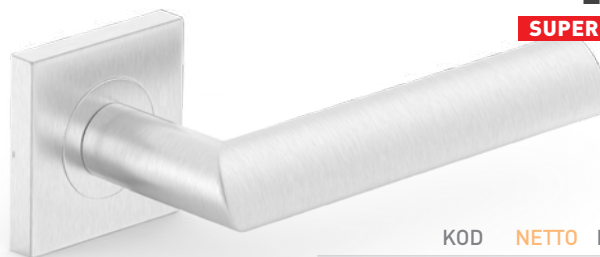

	KOD	NETTO	BRUTTO
	LNOK	42,75	52,59
	SSKK	15,26	18,77
	SSKY	15,26	18,77
	SSKW	31,48	38,72

STAL NIERDZEWNA

LEDA



	KOD	NETTO	BRUTTO
	LNO	31,09	38,24
	NNK	10,60	13,04
	NNY	10,60	13,04
	NNWC	24,80	30,51

STAL NIERDZEWNA

ELEKTRA

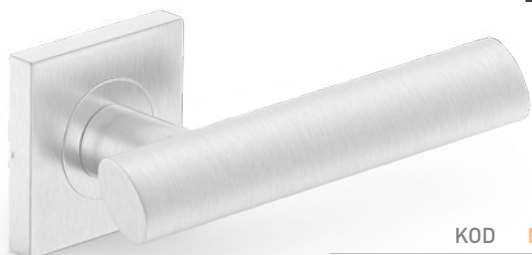

	KOD	NETTO	BRUTTO
	ENOK	42,75	52,59
	SSKK	15,26	18,77
	SSKY	15,26	18,77
	SSKW	31,48	38,72

STAL NIERDZEWNA

ELEKTRA



	KOD	NETTO	BRUTTO
	ENO	34,98	43,03
	NNK	10,60	13,04
	NNY	10,60	13,04
	NNWC	24,80	30,51

STAL NIERDZEWNA

PROXIMA

SUPER CENA



	KOD	NETTO	BRUTTO
	PNOK	42,75	52,59
	SSKK	15,26	18,77
	SSKY	15,26	18,77
	SSKWC	31,48	38,72

STAL NIERDZEWNA

PROXIMA

SUPER CENA



	KOD	NETTO	BRUTTO
	PNO	34,98	43,03
	NNK	10,60	13,04
	NNY	10,60	13,04
	NNWC	24,80	30,51

STAL NIERDZEWNA

NEPTUN

SUPER CENA

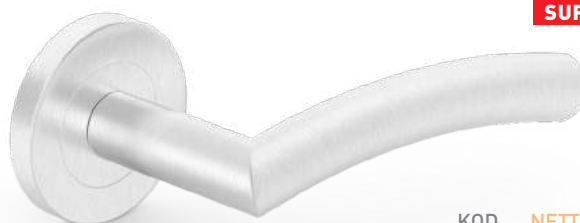

	KOD	NETTO	BRUTTO
	NNO	31,09	38,24
	NNK	10,60	13,04
	NNY	10,60	13,04
	NNWC	24,80	30,51

STAL NIERDZEWNA

DOMINO

SUPER CENA



	KOD	NETTO	BRUTTO
	DNO	31,09	38,24
	NNK	10,60	13,04
	NNY	10,60	13,04
	NNWC	24,80	30,51

STAL NIERDZEWNA

JOWISZ

SUPER CENA



F

	KOD	NETTO	BRUTTO
	JNO	29,34	36,08
	NNK	10,60	13,04
	NNY	10,60	13,04
	NNWC	24,80	30,51

STAL NIERDZEWNA

GAŁKA

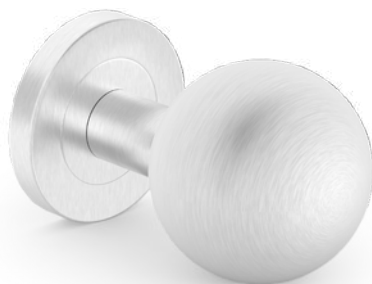

	KOD	NETTO	BRUTTO
	SGSPKS	48,58	59,76
	NNK	10,60	13,04
	NNY	10,60	13,04
	NNWC	24,80	30,51

STAL NIERDZEWNA

Cena za 1 szt. w konfiguracji stałej lub obrotowej*

GAŁKA

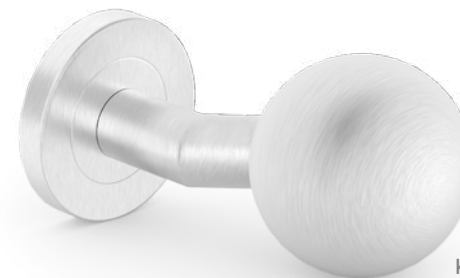

F

	KOD	NETTO	BRUTTO
	SGSO	48,58	59,76
	NNK	10,60	13,04
	NNY	10,60	13,04
	NNWC	24,80	30,51

STAL NIERDZEWNA

Cena za 1 szt. w konfiguracji stałej lub obrotowej*

JOWISZ

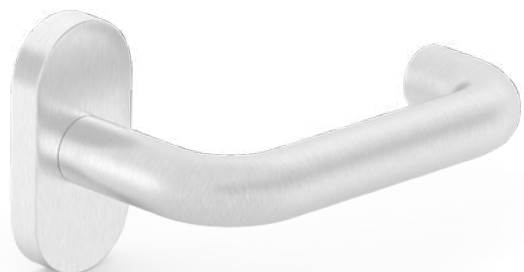

F

	KOD	NETTO	BRUTTO
	JNOW	45,71	56,23
	NNOW	12,19	14,99
	NNOWB	12,19	14,99

STAL NIERDZEWNA

GAŁKA

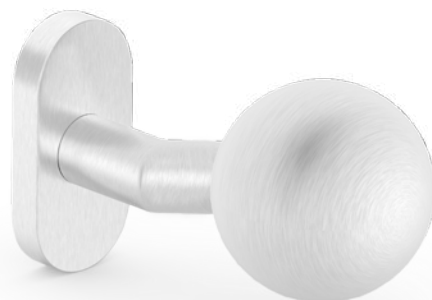

F

	KOD	NETTO	BRUTTO
	SGOW	50,79	62,47
	NNOW	12,19	14,99
	NNOWB	12,19	14,99

STAL NIERDZEWNA

Cena za 1 szt. w konfiguracji stałej lub obrotowej*

GAŁKA

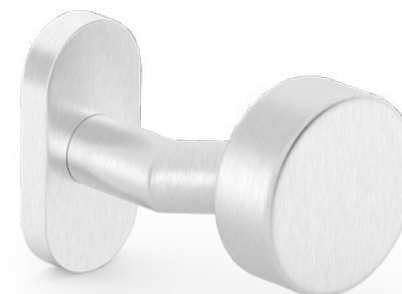

F

	KOD	NETTO	BRUTTO
	PGOW	40,63	49,98
	NNOW	12,19	14,99
	NNOWB	12,19	14,99

STAL NIERDZEWNA

Cena za 1 szt. w konfiguracji stałej lub obrotowej*

NOVA

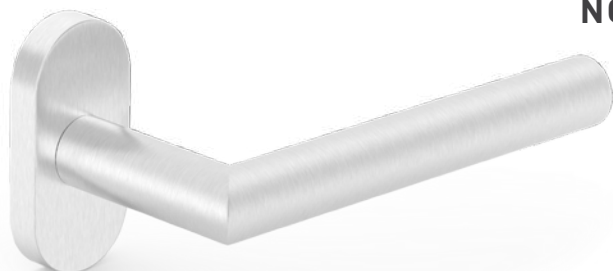

	KOD	NETTO	BRUTTO
	NOVOW	45,71	56,23
	NNOW	12,19	14,99
	NNOWB	12,19	14,99

STAL NIERDZEWNA

TOPAZ

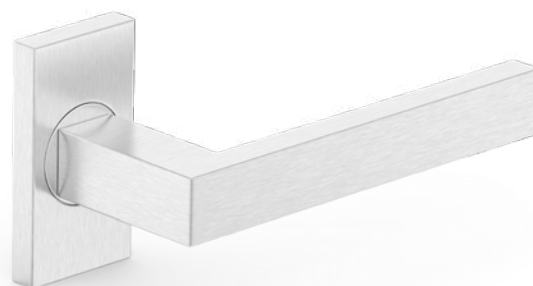

	KOD	NETTO	BRUTTO
	STPR	76,19	93,71
	NNPR	18,29	22,49
	NNPRB	18,29	22,49

STAL NIERDZEWNA

ONYX



STAL NIERDZEWNA

	KOD	NETTO	BRUTTO
	SOK7K	60,24	74,10
	SOK7Y	60,24	74,10
	SOK7W	73,85	90,83
	SOKB	60,24	74,10

* Pozostałe konfiguracje gatek; stałe, obrotowe oraz gałko-klamki dostępne na www.metal-bud.eu i na b2b.metal-bud.eu.

F Istnieje możliwość zastosowania przy stolarnie ognioodpornej, szczegółowe informacje dostępne na www.metal-bud.eu.



TOPAZ

STAL
NIERDZEWNA

	KOD	NETTO	BRUTTO
o	STK7K	56,36	69,32
o	STK7Y	56,36	69,32
wc	STK7W	69,96	86,05
	STKB	56,36	69,32



F JOWISZ 165MM

STAL
NIERDZEWNA

	KOD	NETTO	BRUTTO
o	JK7YN	81,62	100,39



F JOWISZ 225MM

STAL
NIERDZEWNA

	KOD	NETTO	BRUTTO
o	JD7KN	85,33	104,96
o	JD7YN	85,33	104,96
wc	JD7WN	125,96	154,93
	JDBN	85,33	104,96



F GAŁKA 225MM

STAL
NIERDZEWNA

Cena za 1 szt. w konfiguracji
stałej lub obrotowej*

	KOD	NETTO	BRUTTO
o	GD7KN	81,27	99,96
o	GD7YN	81,27	99,96
wc	GD7WN	91,43	112,45
	GDBN	81,27	99,96



F GAŁKA 165MM

STAL
NIERDZEWNA

Cena za 1 szt. w konfiguracji
stałej lub obrotowej*

	KOD	NETTO	BRUTTO
o	GKON	81,27	99,96



NOVA 225MM

STAL
NIERDZEWNA

	KOD	NETTO	BRUTTO
o	ND7KN	85,33	104,96
o	ND7YN	85,33	104,96
wc	ND7WN	125,96	154,93
	NDBN	85,33	104,96



GAŁKA

STAL
NIERDZEWNA

Cena za 1 szt. w konfiguracji
stałej lub obrotowej*

	KOD	NETTO	BRUTTO
o	WPGG7	60,95	74,97
o	WPGG9	60,95	74,97
o	WPGG2	60,95	74,97
	WPGGB	60,95	74,97



PROXIMA

STAL
NIERDZEWNA

	KOD	NETTO	BRUTTO
o	WPKK7	89,39	109,95
o	WPKK9	89,39	109,95
o	WPKK2	89,39	109,95
	WPKKB	89,39	109,95



PROXIMA OKIENNA

STAL NIERDZEWNA

	KOD	NETTO	BRUTTO
o	KOP	24,38	29,99

PROXIMA OKIENNA



CZARNY

KOD	NETTO	BRUTTO
 KOPCZ	38,60	47,48

NOVA OKIENNA



STAL NIERDZEWNA

KOD	NETTO	BRUTTO
 KON	24,38	29,99

NOVA OKIENNA



CZARNY

KOD	NETTO	BRUTTO
 KONCZ	38,60	47,48

TOPAZ OKIENNY



STAL NIERDZEWNA

KOD	NETTO	BRUTTO
 KOT	28,44	34,99

TOPAZ OKIENNY



CZARNY

KOD	NETTO	BRUTTO
 KOTCZ	42,67	52,48

JOWISZ OKIENNY





STAL NIERDZEWNA

KOD	NETTO	BRUTTO
 KOJ	24,38	29,99

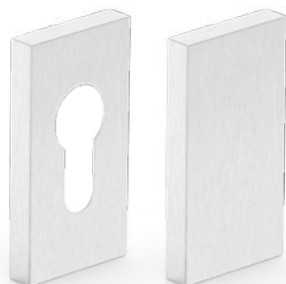
SZYLDY WĄSKIE PROSTOKĄTNE





STAL
NIERDZEWNA

KOD	NETTO	BRUTTO
 NNPR	18,29	22,49
 NNPRB	18,29	22,49

SZYLDY WĄSKIE OWALNE



STAL
NIERDZEWNA

KOD	NETTO	BRUTTO
 NNOW	12,19	14,99
 NNOWB	12,19	14,99

SZYLD GÓRNY DO KLAMKI TOPAZ I ONYX



STAL
NIERDZEWNA

KOD	NETTO	BRUTTO
 SGTKN	20,32	24,99

UCHWYT PROSTOKĄTNY



	KOD	NETTO	BRUTTO
STAL NIERDZEWNA	UNPW	18,29	22,49
CZARNY	UCZPW	27,43	33,74

UCHWYT OWALNY



	KOD	NETTO	BRUTTO
STAL NIERDZEWNA	UNOW	16,25	19,99
CZARNY	UCZOW	24,38	29,99

ODBOJNIK WALEC

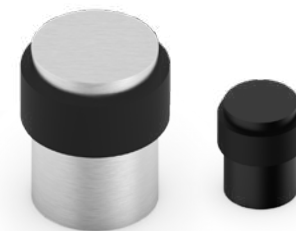

	KOD	NETTO	BRUTTO
STAL NIERDZEWNA	NOW	28,44	34,99
CZARNY	NOWPCZ	40,63	49,98

ODBOJNIK WALEC DO DRZWI ZEWNĘTRZNYCH



	KOD	NETTO	BRUTTO
STAL NIERDZEWNA	NOWD	60,95	74,97
CZARNY	CZOWD	91,43	112,45

ODBOJNIK PÓŁKULA

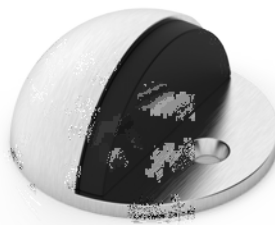

	KOD	NETTO	BRUTTO
STAL NIERDZEWNA	NOP	20,32	24,99

ODBOJNIK ŚCIENNY



	KOD	NETTO	BRUTTO
STAL NIERDZEWNA	OSN	22,35	27,49

UCHWYT DO PORĘCZY



	KOD	NETTO	BRUTTO
STAL NIERDZEWNA	UPNM	42,67	52,48

UCHWYT DO PORĘCZY

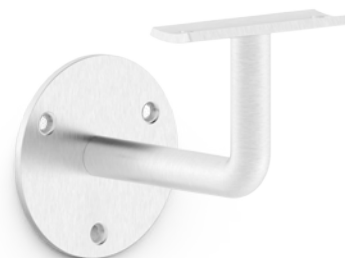

	KOD	NETTO	BRUTTO
STAL NIERDZEWNA	UPND	32,51	39,98

ODBOJNIK ŚCIENNY WALEC

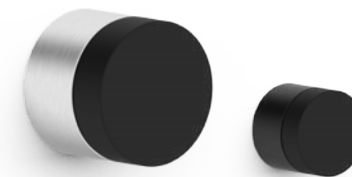

	KOD	NETTO	BRUTTO
STAL NIERDZEWNA	OSNW	28,44	34,99
CZARNY	OSNWCZ	34,54	42,48

KOMPLET OKUĆ OKRĄGLY



CZARNY

ZESTAW ZAWIERA:	STRONY	KOD	NETTO	BRUTTO
ZAMEK, KLAMKĘ,		SZOBPPC	553,85	681,24
ZAWIASY NA SZKŁO		SZOBLPC	553,85	681,24

KOMPLET OKUĆ OKRĄGLY



CZARNY

ZESTAW ZAWIERA:	STRONY	KOD	NETTO	BRUTTO
ZAMEK, KLAMKĘ,		SZOKPPC	563,57	693,19
ZAWIASY NA SZKŁO		SZOKLPC	563,57	693,19

KOMPLET OKUĆ OKRĄGLY



CZARNY

ZESTAW ZAWIERA:	STRONY	KOD	NETTO	BRUTTO
ZAMEK, KLAMKĘ,		SZOYPPC	553,85	681,24
ZAWIASY NA SZKŁO		SZOYLPC	553,85	681,24

KOMPLET OKUĆ OKRĄGLY



CZARNY

ZESTAW ZAWIERA:	STRONY	KOD	NETTO	BRUTTO
ZAMEK, KLAMKĘ,		SZOWWPPC	660,73	812,70
ZAWIASY NA SZKŁO		SZOWWLPC	660,73	812,70

KOMPLET OKUĆ OKRĄGLY

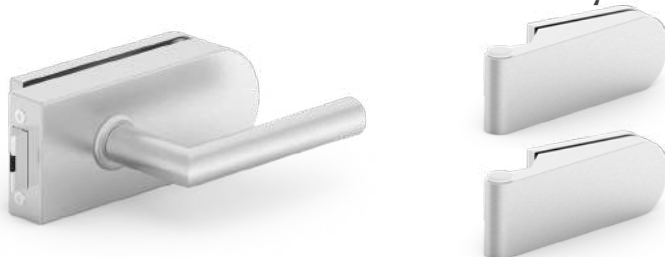

STAL NIERDZEWNA

ZESTAW ZAWIERA:	STRONY	KOD	NETTO	BRUTTO
ZAMEK, KLAMKĘ,		SZOBP	469,55	577,54
ZAWIASY NA SZKŁO		SZOBL	469,55	577,54

KOMPLET OKUĆ OKRĄGLY

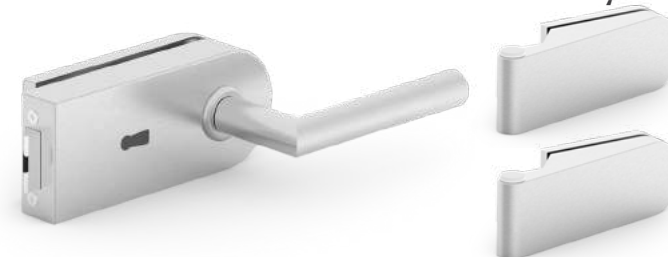

STAL NIERDZEWNA

ZESTAW ZAWIERA:	STRONY	KOD	NETTO	BRUTTO
ZAMEK, KLAMKĘ,		SZOKP	473,88	582,87
ZAWIASY NA SZKŁO		SZOKL	473,88	582,87

KOMPLET OKUĆ OKRĄGLY

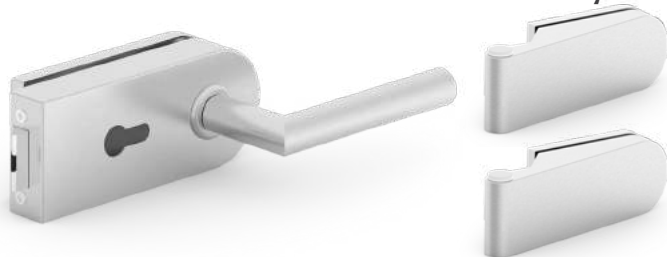

STAL NIERDZEWNA

ZESTAW ZAWIERA:	STRONY	KOD	NETTO	BRUTTO
ZAMEK, KLAMKĘ,		SZOYP	469,55	577,54
ZAWIASY NA SZKŁO		SZOYL	469,55	577,54

KOMPLET OKUĆ OKRĄGLY

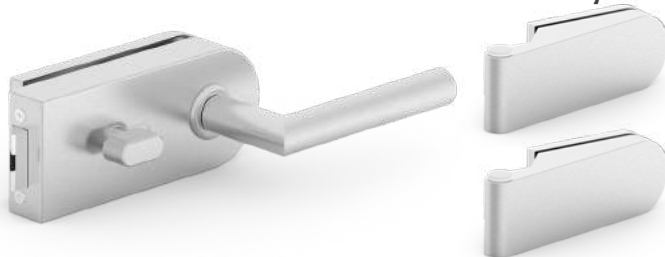

STAL NIERDZEWNA

ZESTAW ZAWIERA:	STRONY	KOD	NETTO	BRUTTO
ZAMEK, KLAMKĘ,		SZOWWP	553,50	680,81
ZAWIASY NA SZKŁO		SZOWWL	553,50	680,81

ZAWIASY NA SZKŁO OKRĄGŁE



*Cena za komplet - 2 zawiasy

STAL NIERDZEWNA	KOD	NETTO	BRUTTO
●	SZAWOH	244,30*	300,49*
●	SZAWOHPC	269,69*	332,05*

KOMPLET OKUĆ KWADRATOWY



CZARNY

ZESTAW ZAWIERA:	STRONY	KOD	NETTO	BRUTTO
ZAMEK, KLAMKĘ,		SZKBPPC	563,57	693,19
ZAWIASY NA SZKŁO		SZKBLPC	563,57	693,19

KOMPLET OKUĆ KWADRATOWY

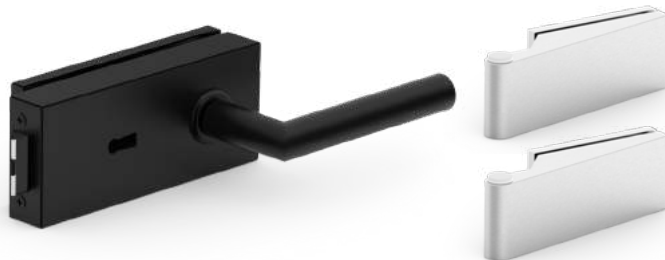

CZARNY

ZESTAW ZAWIERA:	STRONY	KOD	NETTO	BRUTTO
ZAMEK, KLAMKĘ,		SZKKPPC	573,28	705,14
ZAWIASY NA SZKŁO		SZKKLPC	573,28	705,14

KOMPLET OKUĆ KWADRATOWY

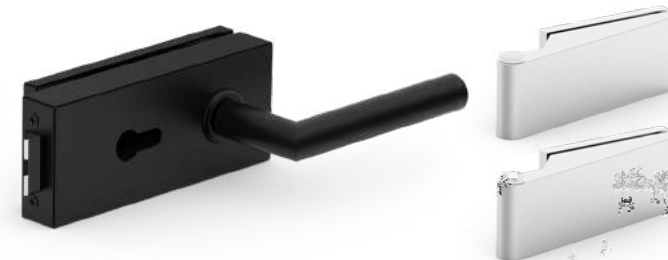

CZARNY

ZESTAW ZAWIERA:	STRONY	KOD	NETTO	BRUTTO
ZAMEK, KLAMKĘ,		SZKYPPC	563,57	693,19
ZAWIASY NA SZKŁO		SZKYLPC	563,57	693,19

KOMPLET OKUĆ KWADRATOWY

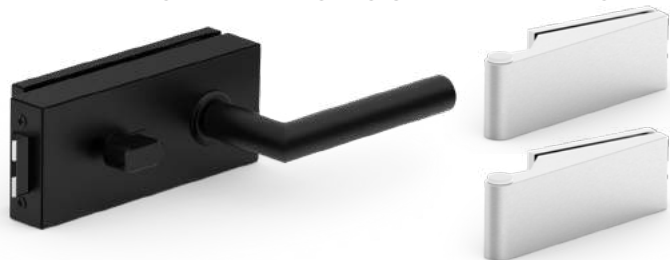

CZARNY

ZESTAW ZAWIERA:	STRONY	KOD	NETTO	BRUTTO
ZAMEK, KLAMKĘ,		SZKWWPPC	680,17	836,61
ZAWIASY NA SZKŁO		SZKWWLPC	680,17	836,61

KOMPLET OKUĆ KWADRATOWY



STAL NIERDZEWNA

ZESTAW ZAWIERA:	STRONY	KOD	NETTO	BRUTTO
ZAMEK, KLAMKĘ,		SZKBP	479,61	589,93
ZAWIASY NA SZKŁO		SZKBL	479,61	589,93

KOMPLET OKUĆ KWADRATOWY

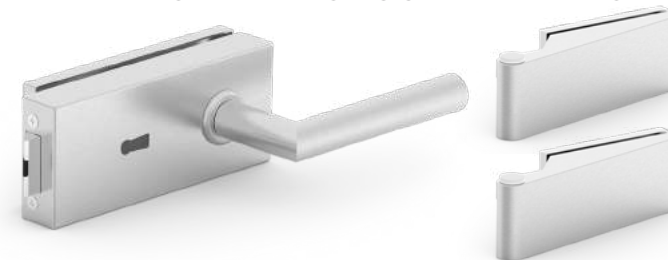

STAL NIERDZEWNA

ZESTAW ZAWIERA:	STRONY	KOD	NETTO	BRUTTO
ZAMEK, KLAMKĘ,		SZKKP	486,47	598,36
ZAWIASY NA SZKŁO		SZKKL	486,47	598,36

KOMPLET OKUĆ KWADRATOWY

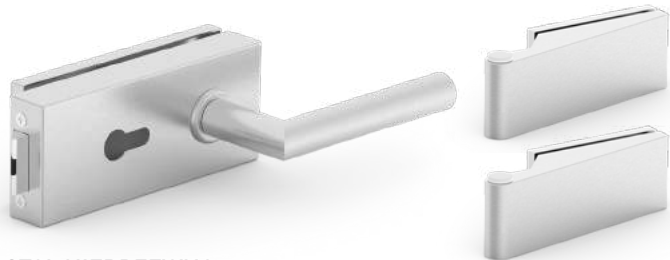

STAL NIERDZEWNA

ZESTAW ZAWIERA:	STRONY	KOD	NETTO	BRUTTO
ZAMEK, KLAMKĘ,		SZKYP	479,61	589,93
ZAWIASY NA SZKŁO		SZKYL	479,61	589,93

KOMPLET OKUĆ KWADRATOWY

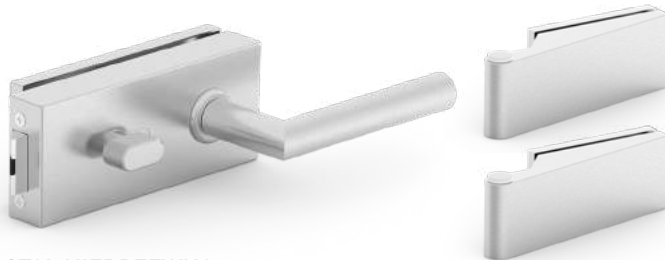

STAL NIERDZEWNA

ZESTAW ZAWIERA:	STRONY	KOD	NETTO	BRUTTO
ZAMEK, KLAMKĘ,		SZKWPP	563,57	693,19
ZAWIASY NA SZKŁO		SZKWLL	563,57	693,19

ZAWIASY NA SZKŁO KWADRATOWE



*Cena za komplet - 2 zawiasy

STAL NIERDZEWNA	KOD	NETTO	BRUTTO
●	SZAWKH	244,30*	300,49*
●	SZAWKHPC	269,96*	332,05*

RĘKOJEŚĆ QUATTRO



	KOD	NETTO	BRUTTO
STAL NIERDZEWNA	SREKQ	122,65	150,86
CZARNY	SREKQPC	183,60	225,83

ZAWIAS DO DRZWI PROFILOWANYCH



	KOD	NETTO	BRUTTO
STAL NIERDZEWNA	SZAPRO	77,73	95,61

ZAWIASY WZMOCNIONIONE



STAL NIERDZEWNA
Cena za 2 szt.

	KOD	NETTO	BRUTTO
OKRĄGŁY	SZAWOW	307,82	378,62
KWADRATOWY	SZAWKW	307,82	378,62

PRZECIWKASETA MAŁA OKRĄGŁA



	KOD	NETTO	BRUTTO
STAL NIERDZEWNA	SPRZOM	87,45	107,56
CZARNY	SPRZOMPC	155,47	191,22

PRZECIWKASETA MAŁA KWADRATOWA

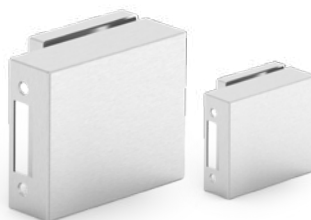

	KOD	NETTO	BRUTTO
STAL NIERDZEWNA	SPRZKM	97,17	119,52
CZARNY	SPRZKMPC	165,18	203,18

BLACHA DO OŚCIEŻNICY KWADRATOWA



	KOD	NETTO	BRUTTO
STAL NIERDZEWNA	BZACZ	19,43	23,90
CZARNY	BZACZCZSZ	29,15	35,85

ZAWIASY DO OŚCIEŻNICY DREWNIANEJ

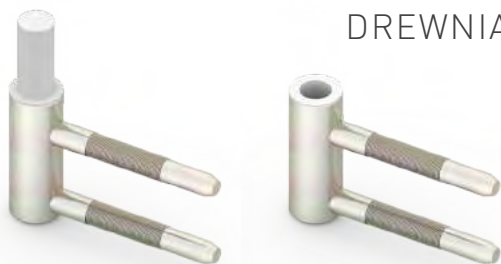

	KOD	NETTO	BRUTTO
ZAWIAS STANDARD	SZAWDH	6,80	8,37
ZAWIAS WZMACNIANY	SZAWDW	14,58	17,93

ZAWIASY DO OŚCIEŻNICY STALOWEJ

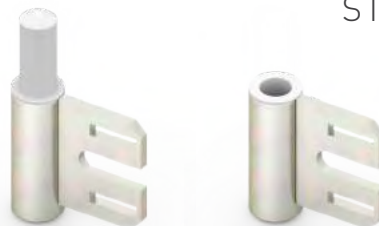

	KOD	NETTO	BRUTTO
ZAWIAS STANDARD	SZAWSH	13,99	17,21
ZAWIAS WZMACNIANY	SZAWSW	18,07	22,23

ANTABA DO DRZWI ŁAZIENKOWYCH



	KOD	NETTO	BRUTTO
STAL NIERDZEWNA	AOPJ32	116,60	143,42
CZARNY	AOPJ32CZ	166,95	205,35

ANTABA OKRĄGŁA PROSTA Ø35 MM

STAL NIERDZEWNA

KOD	DŁUGOŚĆ CAŁKOWITA	ROZSTAW ELEMENTÓW	ANTABA POJEDYŃCZA PREMIUM		ANTABA POJEDYŃCZA PRZELOT		ANTABA PODWÓJNA	
			NETTO	BRUTTO	NETTO	BRUTTO	NETTO	BRUTTO
AOPJ05	50	30	231,88	285,21	250,43	308,02	463,75	570,41
AOPJ08	80	50	250,43	308,02	268,98	330,84	500,85	616,05
AOPJ10	100	50	268,98	330,84	287,53	353,66	537,95	661,68
AOPJ12	120	80	287,53	353,66	306,08	376,47	575,05	707,31
AOPJ15	150	100	306,08	376,47	324,63	399,29	612,15	752,94
AOPJ17	170	100	333,90	410,70	352,45	433,51	667,80	821,39

ANTABA OKRĄGŁA SKOŚNA Ø35 MM

STAL NIERDZEWNA

KOD	DŁUGOŚĆ CAŁKOWITA	ROZSTAW ELEMENTÓW	ANTABA POJEDYŃCZA PREMIUM		ANTABA POJEDYŃCZA PRZELOT		ANTABA PODWÓJNA	
			NETTO	BRUTTO	NETTO	BRUTTO	NETTO	BRUTTO
AOSJ05	50	30	250,43	308,02	268,98	330,84	500,85	616,05
AOSJ08	80	50	268,98	330,84	287,53	353,66	537,95	661,68
AOSJ10	100	50	287,53	353,66	306,08	376,47	575,05	707,31
AOSJ12	120	80	306,08	376,47	324,63	399,29	612,15	752,94
AOSJ15	150	100	324,63	399,29	343,18	422,11	649,25	798,58
AOSJ17	170	100	352,45	433,51	371,00	456,33	704,90	867,03

ANTABA OKRĄGŁA PROSTA Ø35 MM

CZARNY*

KOD	DŁUGOŚĆ CAŁKOWITA	ROZSTAW ELEMENTÓW	ANTABA POJEDYŃCZA PREMIUM		ANTABA POJEDYŃCZA PRZELOT		ANTABA PODWÓJNA	
			NETTO	BRUTTO	NETTO	BRUTTO	NETTO	BRUTTO
AOPJ05CZ	50	30	324,63	399,29	343,18	422,11	649,25	798,58
AOPJ08CZ	80	50	343,18	422,11	361,73	444,92	686,35	844,21
AOPJ10CZ	100	50	361,73	444,92	380,28	467,74	723,45	889,84
AOPJ12CZ	120	80	380,28	467,74	398,83	490,55	760,55	935,48
AOPJ15CZ	150	100	398,83	490,55	417,38	513,37	797,65	981,11
AOPJ17CZ	170	100	426,65	524,78	445,20	547,60	853,30	1049,56

ANTABA OKRĄGŁA SKOŚNA Ø35 MM

CZARNY*

KOD	DŁUGOŚĆ CAŁKOWITA	ROZSTAW ELEMENTÓW	ANTABA POJEDYŃCZA PREMIUM		ANTABA POJEDYŃCZA PRZELOT		ANTABA PODWÓJNA	
			NETTO	BRUTTO	NETTO	BRUTTO	NETTO	BRUTTO
AOSJ05CZ	50	30	343,18	422,11	361,73	444,92	686,35	844,21
AOSJ08CZ	80	50	361,73	444,92	380,28	467,74	723,45	889,84
AOSJ10CZ	100	50	380,28	467,74	398,83	490,55	760,55	935,48
AOSJ12CZ	120	80	398,83	490,55	417,38	513,37	797,65	981,11
AOSJ15CZ	150	100	417,38	513,37	435,93	536,19	834,75	1026,74
AOSJ17CZ	170	100	445,20	547,60	463,75	570,41	890,40	1095,19

ANTABA PROSTOKĄTNA PROSTA 40mm x 20mm

STAL NIERDZEWNA

KOD	DŁUGOŚĆ CAŁKOWITA	ROZSTAW ELEMENTÓW	ANTABA POJEDYŃCZA PREMIUM		ANTABA POJEDYŃCZA PRZELOT		ANTABA PODWÓJNA	
			NETTO	BRUTTO	NETTO	BRUTTO	NETTO	BRUTTO
APPJ05	50	30	241,15	296,61	259,70	319,43	482,30	593,23
APPJ08	80	50	259,70	319,43	278,25	342,25	519,40	638,86
APPJ10	100	50	278,25	342,25	296,80	365,06	556,50	684,50
APPJ12	120	80	296,80	365,06	315,35	387,88	593,60	730,13
APPJ15	150	100	315,35	387,88	333,90	410,70	519,40	638,86
APPJ17	170	100	333,90	410,70	352,45	433,51	667,80	821,39

ANTABA PROSTOKĄTNA SKOŚNA 40mm x 20mm

STAL NIERDZEWNA

KOD	DŁUGOŚĆ CAŁKOWITA	ROZSTAW ELEMENTÓW	ANTABA POJEDYŃCZA PREMIUM		ANTABA POJEDYŃCZA PRZELOT		ANTABA PODWÓJNA	
			NETTO	BRUTTO	NETTO	BRUTTO	NETTO	BRUTTO
APSJ05	50	30	278,25	342,25	296,80	365,06	556,50	684,50
APSJ08	80	50	296,80	365,06	315,35	387,88	593,60	730,13
APSJ10	100	50	315,35	387,88	333,90	410,70	630,70	775,76
APSJ12	120	80	333,90	410,70	352,45	433,51	667,80	821,39
APSJ15	150	100	352,45	433,51	371,00	456,33	704,90	867,03
APSJ17	170	100	389,55	479,15	408,10	501,96	779,10	958,29

* Antaby w kolorze czarnym dostępne na zamówienie, w terminie 2 tygodni.

ANTABA PROSTOKĄTNA PROSTA 40mm x 20mm

CZARNY*

KOD	DŁUGOŚĆ CAŁKOWITA	ROZSTAW ELEMENTÓW	ANTABA POJEDYŃCZA PREMIUM		ANTABA POJEDYŃCZA PRZELOT		ANTABA PODWÓJNA	
			NETTO	BRUTTO	NETTO	BRUTTO	NETTO	BRUTTO
APPJ05CZ	50	30	333,90	410,70	352,45	433,51	667,80	821,39
APPJ08CZ	80	50	352,45	433,51	371,00	456,33	704,90	867,03
APPJ10CZ	100	50	371,00	456,33	389,55	479,15	742,00	912,66
APPJ12CZ	120	80	389,55	479,15	408,10	501,96	593,60	730,13
APPJ15CZ	150	100	408,10	501,96	426,65	524,78	816,20	1003,93
APPJ17CZ	170	100	426,65	524,78	445,20	547,60	853,30	1049,56

ANTABA PROSTOKĄTNA SKOŚNA 40mm x 20mm

CZARNY*

KOD	DŁUGOŚĆ CAŁKOWITA	ROZSTAW ELEMENTÓW	ANTABA POJEDYŃCZA PREMIUM		ANTABA POJEDYŃCZA PRZELOT		ANTABA PODWÓJNA	
			NETTO	BRUTTO	NETTO	BRUTTO	NETTO	BRUTTO
APSJ05CZ	50	30	371,00	456,33	389,55	479,15	742,00	912,66
APSJ08CZ	80	50	389,55	479,15	408,10	501,96	779,10	958,29
APSJ10CZ	100	50	408,10	501,96	426,65	524,78	816,20	1003,93
APSJ12CZ	120	80	426,65	524,78	445,20	547,60	853,30	1049,56
APSJ15CZ	150	100	445,20	547,60	463,75	570,41	890,40	1095,19
APSJ17CZ	170	100	482,30	593,23	500,85	616,05	964,60	1186,46

OZNACZENIA DRZWI KLEJONE

STAL NIERDZEWNA



	KOD	ROZMIAR 76 MM	
		NETTO	BRUTTO
TOALETA OGÓLNE	ONWCOK	16,05	19,74
TOALETA MĘSKA	ONWCMK	16,05	19,74
TOALETA DAMSKA	ONWCDK	16,05	19,74
TOALETA DLA INWALIDY	ONINWK	16,05	19,74
PRZEWIJALNIA	ONDZIK	16,05	19,74
PRYSZNIC	ONPRK	16,05	19,74
ZAKAZ DZWONIENIA	ONTELK	16,05	19,74
ZAKAZ PALENIA	ONPAPK	16,05	19,74
STRZAŁKA	ONKIEK	16,05	19,74

OZNACZENIA DRZWI PRZYKRĘCANE

STAL NIERDZEWNA



	KOD	ROZMIAR 76 MM	
		NETTO	BRUTTO
TOALETA OGÓLNE	ONWCOP	13,92	17,12
TOALETA MĘSKA	ONWCMP	13,92	17,12
TOALETA DAMSKA	ONWCDP	13,92	17,12
TOALETA DLA INWALIDY	ONINWP	13,92	17,12
PRZEWIJALNIA	ONDZIP	13,92	17,12
PRYSZNIC	ONPRP	13,92	17,12
ZAKAZ DZWONIENIA	ONTELP	13,92	17,12
ZAKAZ PALENIA	ONPAPP	13,92	17,12
STRZAŁKA	ONKIEP	13,92	17,12

OZNACZENIA BUDYNKÓW PRZYKRĘCANE

STAL NIERDZEWNA



	KOD	ROZMIAR 76 MM	
		NETTO	BRUTTO
CYFRA 0	OBCN0	34,13	41,98
CYFRA 1	OBCN1	34,13	41,98
CYFRA 2	OBCN2	34,13	41,98
CYFRA 3	OBCN3	34,13	41,98
CYFRA 4	OBCN4	34,13	41,98
CYFRA 5	OBCN5	34,13	41,98
CYFRA 6	OBCN6	34,13	41,98
CYFRA 7	OBCN7	34,13	41,98
CYFRA 8	OBCN8	34,13	41,98
CYFRA 9	OBCN9	34,13	41,98
ZNAK /	OBCN/	40,23	49,48

OZNACZENIA BUDYNKÓW PRZYKRĘCANE

STAL NIERDZEWNA



	KOD	ROZMIAR 76 MM	
		NETTO	BRUTTO
LITERA a	OBLNAM	34,13	41,98
LITERA b	OBLNBM	34,13	41,98
LITERA c	OBLNCM	34,13	41,98
LITERA d	OBLNDM	34,13	41,98



DIANA

SUPER CENA

NIKIEL SZCZOTKOWANY

	KOD	NETTO	BRUTTO
o 72	ZD7KN	36,00	44,28
o 72	ZD7YN	36,00	44,28
wc 72	ZD7WN	45,00	55,35
	ZDBN	36,00	44,28
o 90	ZD9KN	36,00	44,28
o 90	ZD9YN	36,00	44,28



DIANA

SUPER CENA

PATYNA

	KOD	NETTO	BRUTTO
o 72	ZD7KP	36,00	44,28
o 72	ZD7YP	36,00	44,28
wc 72	ZD7WP	45,00	55,35
	ZDBP	36,00	44,28
o 90	ZD9KP	36,00	44,28
o 90	ZD9YP	36,00	44,28



NICOLE

SUPER CENA

NIKIEL SZCZOTKOWANY

	KOD	NETTO	BRUTTO
o 72	VN7KN	36,00	44,28
o 72	VN7YN	36,00	44,28
wc 72	VN7WN	45,00	55,35
	VNBN	36,00	44,28
o 90	VN9KN	36,00	44,28
o 90	VN9YN	36,00	44,28



NICOLE

SUPER CENA

PATYNA

	KOD	NETTO	BRUTTO
o 72	VN7KP	36,00	44,28
o 72	VN7YP	36,00	44,28
wc 72	VN7WP	45,00	55,35
	VNBP	36,00	44,28
o 90	VN9KP	36,00	44,28
o 90	VN9YP	36,00	44,28



SYDNEY

SUPER CENA

NIKIEL SZCZOTKOWANY

	KOD	NETTO	BRUTTO
o 72	VS7KN	36,00	44,28
o 72	VS7YN	36,00	44,28
wc 72	VS7WN	45,00	55,35
	VSBN	36,00	44,28
o 90	VS9KN	36,00	44,28
o 90	VS9YN	36,00	44,28



SYDNEY

SUPER CENA

PATYNA

	KOD	NETTO	BRUTTO
o 72	VS7KP	36,00	44,28
o 72	VS7YP	36,00	44,28
wc 72	VS7WP	45,00	55,35
	VSBP	36,00	44,28
o 90	VS9KP	36,00	44,28
o 90	VS9YP	36,00	44,28



LIBRA

SUPER CENA

NIKIEL SZCZOTKOWANY

	KOD	NETTO	BRUTTO
o 72	ZL7KN	36,00	44,28
o 72	ZL7YN	36,00	44,28
wc 72	ZL7WN	45,00	55,35
	ZLBN	36,00	44,28
o 90	ZL9KN	36,00	44,28
o 90	ZL9YN	36,00	44,28



LIBRA

SUPER CENA

PATYNA

	KOD	NETTO	BRUTTO
o 72	ZL7KP	36,00	44,28
o 72	ZL7YP	36,00	44,28
wc 72	ZL7WP	45,00	55,35
	ZLBP	36,00	44,28
o 90	ZL9KP	36,00	44,28
o 90	ZL9YP	36,00	44,28



IDEA

SUPER CENA

NIKIEL SZCZOTKOWANY

	KOD	NETTO	BRUTTO
o 72	ZI7KN	28,80	35,43
o 72	ZI7YN	28,80	35,43
wc 72	ZI7WN	37,80	46,49
	ZIBN	28,80	35,43
o 90	ZI9KN	28,80	35,43
o 90	ZI9YN	28,80	35,43



IDEA

SUPER CENA

PATYNA

	KOD	NETTO	BRUTTO
0 72	ZI7KP	28,80	35,43
0 72	ZI7YP	28,80	35,43
wc 72	ZI7WP	37,80	46,49
	ZIBP	28,80	35,43
0 90	ZI9KP	28,80	35,43
0 90	ZI9YP	28,80	35,43



GAŁKA

NIKIEL SZCZOTKOWANY

Cena za 1 szt. w konfiguracji stałej lub obrotowej*

	KOD	NETTO	BRUTTO
0 72	GZ7NSZK	40,63	49,98
0 72	GZ7NSZY	40,63	49,98
wc 72	GZ7NSZW	50,79	62,47
	GZNSZB	40,63	49,98
0 90	GZ9NSZK	40,63	49,98
0 90	GZ9NSZY	40,63	49,98



GAŁKA

PATYNA

Cena za 1 szt. w konfiguracji stałej lub obrotowej*

	KOD	NETTO	BRUTTO
0 72	GZ7PATK	40,63	49,98
0 72	GZ7PATY	40,63	49,98
wc 72	GZ7PATW	50,79	62,47
	GZPATB	40,63	49,98
0 90	GZ9PATK	40,63	49,98
0 90	GZ9PATY	40,63	49,98



FEBE

SUPER CENA

NIKIEL SZCZOTKOWANY

	KOD	NETTO	BRUTTO
0 72	VF7KN	27,00	33,21
0 72	VF7YN	27,00	33,21
wc 72	VF7WN	32,40	39,85
	VFBN	27,00	33,21
0 90	VF9KN	27,00	33,21
0 90	VF9YN	27,00	33,21



ORION

SUPER CENA

PATYNA

	KOD	NETTO	BRUTTO
0 72	ZO7KP	49,17	60,48
0 72	ZO7YP	49,17	60,48
wc 72	ZO7WP	60,95	74,97
	ZOBP	49,17	60,48
0 90	ZO9KP	49,17	60,48
0 90	ZO9YP	49,17	60,48



ASTRA

SUPER CENA

NIKIEL SZCZOTKOWANY

	KOD	NETTO	BRUTTO
0 72	VA7KN	36,00	44,28
0 72	VA7YN	36,00	44,28
wc 72	VA7WN	41,40	50,92
	VABN	36,00	44,28
0 90	VA9KN	36,00	44,28
0 90	VA9YN	36,00	44,28



ASTRA

SUPER CENA

PATYNA

	KOD	NETTO	BRUTTO
0 72	VA7KP	36,00	44,28
0 72	VA7YP	36,00	44,28
wc 72	VA7WP	41,40	50,92
	VABP	36,00	44,28
0 90	VA9KP	36,00	44,28
0 90	VA9YP	36,00	44,28



ASTRA

SUPER CENA

CHROM

	KOD	NETTO	BRUTTO
0 72	VA7KC	36,00	44,28
0 72	VA7YC	36,00	44,28
wc 72	VA7WC	41,40	50,92
	VABC	36,00	44,28
0 90	VA9KC	36,00	44,28
0 90	VA9YC	36,00	44,28



ASTRA

SUPER CENA

CZARNY

	KOD	NETTO	BRUTTO
0 72	VA7KCZ	36,00	44,28
0 72	VA7YCZ	36,00	44,28
wc 72	VA7WCZ	41,40	50,92
	VABCZ	36,00	44,28
0 90	VA9KCZ	36,00	44,28
0 90	VA9YCZ	36,00	44,28



EVA

SUPER CENA

CHROM/SATYNA

	KOD	NETTO	BRUTTO
o 72	VE7KC	47,70	58,67
o 72	VE7YC	47,70	58,67
wc 72	VE7WC	53,42	65,71
	VEBC	47,70	58,67
o 90	VE9KC	47,70	58,67
o 90	VE9YC	47,70	58,67



EVA

SUPER CENA

PATYNA

	KOD	NETTO	BRUTTO
o 72	VE7KP	47,70	58,67
o 72	VE7YP	47,70	58,67
wc 72	VE7WP	53,42	65,71
	VEBP	47,70	58,67
o 90	VE9KP	47,70	58,67
o 90	VE9YP	47,70	58,67



DARO

SUPER CENA

CHROM/SATYNA

	KOD	NETTO	BRUTTO
o 72	VD7KC	47,70	58,67
o 72	VD7YC	47,70	58,67
wc 72	VD7WC	53,42	65,71
	VDBC	47,70	58,67
o 90	VD9KC	47,70	58,67
o 90	VD9YC	47,70	58,67



DARO

SUPER CENA

PATYNA

	KOD	NETTO	BRUTTO
o 72	VD7KP	47,70	58,67
o 72	VD7YP	47,70	58,67
wc 72	VD7WP	53,42	65,71
	VDBP	47,70	58,67
o 90	VD9KP	47,70	58,67
o 90	VD9YP	47,70	58,67



ZORBA

SUPER CENA

CHROM/SATYNA

	KOD	NETTO	BRUTTO
o 72	VZ7KC	32,44	39,90
o 72	VZ7YC	32,44	39,90
wc 72	VZ7WC	38,16	46,94
	VZBC	32,44	39,90
o 90	VZ9KC	32,44	39,90
o 90	VZ9YC	32,44	39,90



ZORBA

SUPER CENA

PATYNA

	KOD	NETTO	BRUTTO
o 72	VZ7KP	32,44	39,90
o 72	VZ7YP	32,44	39,90
wc 72	VZ7WP	38,16	46,94
	VZBP	32,44	39,90
o 90	VZ9KP	32,44	39,90
o 90	VZ9YP	32,44	39,90



CAMILA

SUPER CENA

CHROM/SATYNA

	KOD	NETTO	BRUTTO
o 72	VC7KC	38,16	46,94
o 72	VC7YC	38,16	46,94
wc 72	VC7WC	47,70	58,67
	VCBC	38,16	46,94
o 90	VC9KC	38,16	46,94
o 90	VC9YC	38,16	46,94



CAMILA

SUPER CENA

PATYNA

	KOD	NETTO	BRUTTO
o 72	VC7KP	38,16	46,94
o 72	VC7YP	38,16	46,94
wc 72	VC7WP	47,70	58,67
	VCBP	38,16	46,94
o 90	VC9KP	38,16	46,94
o 90	VC9YP	38,16	46,94



PLEJADA

SUPER CENA

CHROM/SATYNA

	KOD	NETTO	BRUTTO
o 72	VP7KC	38,16	46,94
o 72	VP7YC	38,16	46,94
wc 72	VP7WC	47,70	58,67
	VPBC	38,16	46,94
o 90	VP9KC	38,16	46,94
o 90	VP9YC	38,16	46,94



PLEJADA

SUPER CENA

PATYNA

	KOD	NETTO	BRUTTO
0 72	VP7KP	38,16	46,94
0 72	VP7YP	38,16	46,94
wc 72	VP7WP	47,70	58,67
	VPBP	38,16	46,94
0 90	VP9KP	38,16	46,94
0 90	VP9YP	38,16	46,94



BLANKA

SUPER CENA

CHROM/SATYNA

	KOD	NETTO	BRUTTO
0 72	VB7KC	38,16	46,94
0 72	VB7YC	38,16	46,94
wc 72	VB7WC	47,70	58,67
	VBBC	38,16	46,94
0 90	VB9KC	38,16	46,94
0 90	VB9YC	38,16	46,94



ARTEMIDA

PATYNA

	KOD	NETTO	BRUTTO
0 72	AR7KP	58,30	71,71
0 72	AR7YP	58,30	71,71
wc 72	AR7WP	68,02	83,66
	ARBP	58,30	71,71
0 90	AR9KP	58,30	71,71
0 90	AR9YP	58,30	71,71



EUROPA

SUPER CENA

NIKIEL/SATYNA

	KOD	NETTO	BRUTTO
0 72	EU7KN	52,20	64,20
0 72	EU7YN	52,20	64,20
wc 72	EU7WN	61,20	75,28
	EUBN	53,16	65,39
0 90	EU9KN	52,20	64,20
0 90	EU9YN	52,20	64,20



BETA

SUPER CENA

PATYNA

	KOD	NETTO	BRUTTO
0 72	ZB7KP	50,00	61,50
0 72	ZB7YP	50,00	61,50
wc 72	ZB7WP	58,33	71,75
	ZBBP	50,00	61,50
0 90	ZB9KP	50,00	61,50
0 90	ZB9YP	50,00	61,50

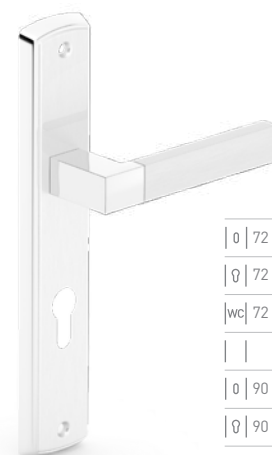

BETA

SUPER CENA

NIKIEL/SATYNA

	KOD	NETTO	BRUTTO
0 72	ZB7KN	50,00	61,50
0 72	ZB7YN	50,00	61,50
wc 72	ZB7WN	58,33	71,75
	ZBBN	50,00	61,50
0 90	ZB9KN	50,00	61,50
0 90	ZB9YN	50,00	61,50



GAŁKA

PATYNA

Cena za 1 szt. w konfiguracji stałej lub obrotowej*

	KOD	NETTO	BRUTTO
0 72	GK7KP	58,30	71,71
0 72	GK7YP	58,30	71,71
wc 72	GK7WP	64,77	79,67
	GKBP	58,30	71,71
0 90	GK9KP	58,30	71,71
0 90	GK9YP	58,30	71,71



GAŁKA

NIKIEL/SATYNA

Cena za 1 szt. w konfiguracji stałej lub obrotowej*

	KOD	NETTO	BRUTTO
0 72	GK7KN	58,30	71,71
0 72	GK7YN	58,30	71,71
wc 72	GK7WN	64,77	79,67
	GKBN	58,30	71,71
0 90	GK9KN	58,30	71,71
0 90	GK9YN	58,30	71,71



QUBIK

SUPER CENA

CZARNY

	KOD	NETTO	BRUTTO
0 72	VQ7KCZ	39,60	48,71
0 72	VQ7YCZ	39,60	48,71
wc 72	VQ7WCZ	45,00	55,35
	VQBCZ	39,60	48,71
0 90	VQ9KCZ	39,60	48,71
0 90	VQ9YCZ	39,60	48,71



QUBIK

SUPER CENA

NIKIEL SZCZOTKOWANY

	KOD	NETTO	BRUTTO
0 72	VQ7KN	39,60	48,71
0 72	VQ7YN	39,60	48,71
wc 72	VQ7WN	42,77	52,60
	VQBN	39,60	48,71
0 90	VQ9KN	39,60	48,71
0 90	VQ9YN	39,60	48,71



PRIMA

PATYNA

	KOD	NETTO	BRUTTO
0 72	PR7KP	53,99	66,41
0 72	PR7YP	53,99	66,41
wc 72	PR7WP	60,46	74,36
	PRBP	53,99	66,41
0 90	PR9KP	53,99	66,41
0 90	PR9YP	53,99	66,41



MONDO

NIKIEL SZCZOTKOWANY

	KOD	NETTO	BRUTTO
0 72	MO7KN	58,30	71,71
0 72	MO7YN	58,30	71,71
wc 72	MO7WN	64,77	79,67
	MOBN	58,30	71,71
0 90	MO9KN	58,30	71,71
0 90	MO9YN	58,30	71,71



MONDO

PATYNA

	KOD	NETTO	BRUTTO
0 72	MO7KP	58,30	71,71
0 72	MO7YP	58,30	71,71
wc 72	MO7WP	64,77	79,67
	MOBP	58,30	71,71
0 90	MO9KP	58,30	71,71
0 90	MO9YP	58,30	71,71



VIVA

NIKIEL SZCZOTKOWANY

	KOD	NETTO	BRUTTO
0 72	VI7KN	58,30	71,71
0 72	VI7YN	58,30	71,71
wc 72	VI7WN	64,77	79,67
	VIBN	58,30	71,71
0 90	VI9KN	58,30	71,71
0 90	VI9YN	58,30	71,71



VIVA

PATYNA

	KOD	NETTO	BRUTTO
0 72	VI7KP	58,30	71,71
0 72	VI7YP	58,30	71,71
wc 72	VI7WP	64,77	79,67
	VIBP	58,30	71,71
0 90	VI9KP	58,30	71,71
0 90	VI9YP	58,30	71,71



GAŁKA

NIKIEL SZCZOTKOWANY

Cena za 1 szt. w konfiguracji stałej lub obrotowej*

	KOD	NETTO	BRUTTO
0 72	GZ7KN	58,30	71,71
0 72	GZ7YN	58,30	71,71
wc 72	GZ7WN	64,77	79,67
	GZBN	58,30	71,71
0 90	GZ9KN	58,30	71,71
0 90	GZ9YN	58,30	71,71



GAŁKA

PATYNA

Cena za 1 szt. w konfiguracji stałej lub obrotowej*

	KOD	NETTO	BRUTTO
0 72	GZ7KP	58,30	71,71
0 72	GZ7YP	58,30	71,71
wc 72	GZ7WP	64,77	79,67
	GZBP	58,30	71,71
0 90	GZ9KP	58,30	71,71
0 90	GZ9YP	58,30	71,71



PRIMA

NIKIEL/SATYNA

	KOD	NETTO	BRUTTO
0 72	PR7KN	53,99	66,40
0 72	PR7YN	53,99	66,40
wc 72	PR7WN	60,46	74,36
	PRBN	34,55	42,50
0 90	PR9KN	53,99	66,40
0 90	PR9YN	53,99	66,40

* Pozostałe konfiguracje gatek; stałe, obrotowe oraz gałko-klamki dostępne na www.metal-bud.eu i na b2b.metal-bud.eu.

TOTAL ZEWNĘTRZNY

SUPER CENA

INOX PLUS

STRONA/ ROZMIAR	KOD	NETTO	BRUTTO
72	T72IL	110,00	135,30
72	T72IP	110,00	135,30
90	T90IL	110,00	135,30
90	T90IP	110,00	135,30
92	T92IL	110,00	135,30
92	T92IP	110,00	135,30

TOTAL ZEWNĘTRZNY

SUPER CENA

CZARNY

STRONA/ ROZMIAR	KOD	NETTO	BRUTTO
72	T72CL	128,34	157,85
72	T72CP	128,34	157,85
90	T90CL	128,34	157,85
90	T90CP	128,34	157,85
92	T92CL	128,34	157,85
92	T92CP	128,34	157,85

TOTAL ZEWNĘTRZNY

SUPER CENA

PATYNA F4

STRONA/ ROZMIAR	KOD	NETTO	BRUTTO
72	T72PL	110,00	135,30
72	T72PP	110,00	135,30
90	T90PL	110,00	135,30
90	T90PP	110,00	135,30
92	T92PL	110,00	135,30
92	T92PP	110,00	135,30

UCHWYT TOTAL ZEWNĘTRZNY

INOX PLUS

STRONA/ ROZMIAR	KOD	NETTO	BRUTTO
72	TU72IL	142,22	174,93
72	TU72IP	142,22	174,93
90	TU90IL	142,22	174,93
90	TU90IP	142,22	174,93
92	TU92IL	142,22	174,93
92	TU92IP	142,22	174,93

UCHWYT TOTAL ZEWNĘTRZNY

CZARNY

STRONA/ ROZMIAR	KOD	NETTO	BRUTTO
72	TU72CL	162,53	199,92
72	TU72CP	162,53	199,92
90	TU90CL	162,53	199,92
90	TU90CP	162,53	199,92
92	TU92CL	162,53	199,92
92	TU92CP	162,53	199,92

UCHWYT TOTAL ZEWNĘTRZNY

PATYNA F4

STRONA/ ROZMIAR	KOD	NETTO	BRUTTO
72	TU72PL	142,22	174,93
72	TU72PP	142,22	174,93
90	TU90PL	142,22	174,93
90	TU90PP	142,22	174,93
92	TU92PL	142,22	174,93
92	TU92PP	142,22	174,93

ZESTAW DO ANTAB TOTAL ZEWNĘTRZNY

INOX PLUS

ROZMIAR	KOD	NETTO	BRUTTO
72	TA72I	142,22	174,93
92	TA92I	142,22	174,93

ZESTAW DO ANTAB TOTAL ZEWNĘTRZNY

CZARNY

ROZMIAR	KOD	NETTO	BRUTTO
72	TA72C	162,53	199,92
92	TA92C	162,53	199,92

METRO ZEWNĘTRZNY

STAL NIERDZEWNA

STRONA/ ROZMIAR	KOD	NETTO	BRUTTO
72	MDK7YL	101,58	124,95
72	MDK7YP	101,58	124,95
90	MDK9YL	101,58	124,95
90	MDK9YP	101,58	124,95
92	MDK2YL	101,58	124,95
92	MDK2YP	101,58	124,95



UCHWYT METRO ZEWNETRZNY

STAL NIERDZEWNA

STRONA/ ROZMIAR	KOD	NETTO	BRUTTO
□ 72	MDU7YL	121,90	149,94
□72	MDU7YP	121,90	149,94
□ 92	MDU2YL	121,90	149,94
□92	MDU2YP	121,90	149,94



ZESTAW DO ANTAB METRO ZEWNETRZNY

STAL NIERDZEWNA

ROZMIAR	KOD	NETTO	BRUTTO
□72	MDA7Y	142,22	174,93
□92	MDA2Y	142,22	174,93



ZESTAW DO ANTAB METRO ZEWNETRZNY

STAL NIERDZEWNA

ROZMIAR	KOD	NETTO	BRUTTO
□72	MDAD7Y	142,22	174,93
□92	MDAD2Y	142,22	174,93



TOPAZ ZEWNETRZNY

STAL NIERDZEWNA

STRONA/ ROZMIAR	KOD	NETTO	BRUTTO
⇌ 72	TDK7YL	111,74	137,44
⇌72	TDK7YP	111,74	137,44
⇌ 90	TDK9YL	111,74	137,44
⇌90	TDK9YP	111,74	137,44
⇌ 92	TDK2YL	111,74	137,44
⇌92	TDK2YP	111,74	137,44



UCHWYT TOPAZ ZEWNETRZNY

STAL NIERDZEWNA

STRONA/ ROZMIAR	KOD	NETTO	BRUTTO
□ 72	TDU7YL	132,06	162,43
□72	TDU7YP	132,06	162,43
□ 90	TDU9YL	132,06	162,43
□90	TDU9YP	132,06	162,43
□ 92	TDU2YL	132,06	162,43
□92	TDU2YP	132,06	162,43



ZESTAW DO ANTAB TOPAZ ZEWNETRZNY

STAL NIERDZEWNA

STRONA/ ROZMIAR	KOD	NETTO	BRUTTO
⇌ 72	TDA7Y	152,38	187,42
⇌72	TDA2Y	152,38	187,42



MIRO WEWNATRZKLATKOWE

SUPER CENA

NIKIEL
SZCZOTKOWANY

STRONA/ ROZMIAR	KOD	NETTO	BRUTTO
⇌ 72	VMINL	45,84	56,38
⇌72	VMINP	45,84	56,38



MIRO WEWNATRZKLATKOWE

SUPER CENA

CZARNY

STRONA/ ROZMIAR	KOD	NETTO	BRUTTO
⇌ 72	VMICZL	52,50	64,58
⇌72	VMICZP	52,50	64,58



MIRO WEWNATRZKLATKOWE

SUPER CENA

PATYNA

STRONA/ ROZMIAR	KOD	NETTO	BRUTTO
⇌ 72	VMIPL	45,84	56,38
⇌72	VMIPP	45,84	56,38



ZEUS WEWNĄTRZKLATKOWY

NIKIEL SZCZOTKOWANY

* Cena z szyldem górnym w komplecie

STRONA/ ROZMIAR	KOD	NETTO	BRUTTO
↔ 72	ZZ7NL	106,88	131,47
↔72	ZZ7NP	106,88	131,47
↔ 90	ZZ9NL	106,88	131,47
↔90	ZZ9NP	106,88	131,47
↔ 92	ZZ92NL	106,88	131,47
↔92	ZZ92NP	106,88	131,47



ZEUS WEWNĄTRZKLATKOWY

PATYNA

* Cena z szyldem górnym w komplecie

STRONA/ ROZMIAR	KOD	NETTO	BRUTTO
↔ 72	ZZ7PL	106,88	131,47
↔72	ZZ7PP	106,88	131,47
↔ 90	ZZ9PL	106,88	131,47
↔90	ZZ9PP	106,88	131,47
↔ 92	ZZ92PL	106,88	131,47
↔92	ZZ92PP	106,88	131,47



UCHWYT ZEUS WEWNĄTRZKLATKOWY

NIKIEL SZCZOTKOWANY

* Cena z szyldem górnym w komplecie

STRONA/ ROZMIAR	KOD	NETTO	BRUTTO
↻ 72	ZU7NL	121,90	149,94
↻72	ZU7NP	121,90	149,94
↻ 90	ZU9NL	121,90	149,94
↻90	ZU9NP	121,90	149,94
↻ 92	ZU92NL	121,90	149,94
↻92	ZU92NP	121,90	149,94



UCHWYT ZEUS WEWNĄTRZKLATKOWY

PATYNA

* Cena z szyldem górnym w komplecie

STRONA/ ROZMIAR	KOD	NETTO	BRUTTO
↻ 72	ZU7PL	121,90	149,94
↻72	ZU7PP	121,90	149,94
↻ 90	ZU9PL	121,90	149,94
↻90	ZU9PP	121,90	149,94
↻ 92	ZU92PL	121,90	149,94
↻92	ZU92PP	121,90	149,94



MAJA WEWNĄTRZKLATKOWA

SUPER CENA

NIKIEL SZCZOTKOWANY

STRONA/ ROZMIAR	KOD	NETTO	BRUTTO
↔ 72	VM7NL	68,02	83,66
↔72	VM7NP	68,02	83,66
↔ 90	VM9NL	68,02	83,66
↔90	VM9NP	68,02	83,66
↔ 92	VM92NL	68,02	83,66
↔92	VM92NP	68,02	83,66



MAJA WEWNĄTRZKLATKOWA

SUPER CENA

PATYNA

STRONA/ ROZMIAR	KOD	NETTO	BRUTTO
↔ 72	VM7PL	68,02	83,66
↔72	VM7PP	68,02	83,66
↔ 90	VM9PL	68,02	83,66
↔90	VM9PP	68,02	83,66
↔ 92	VM92PL	68,02	83,66
↔92	VM92PP	68,02	83,66



OLA BRAMOWA

CZARNY

ROZMIAR	KOD	NETTO	BRUTTO
0 72	B07YC	34,54	42,48
0 90	B09YC	34,54	42,48



ROYAL BRAMOWY

CZARNY

ROZMIAR	KOD	NETTO	BRUTTO
0 72	BR7YC	50,79	62,47
0 90	BR9YC	50,79	62,47

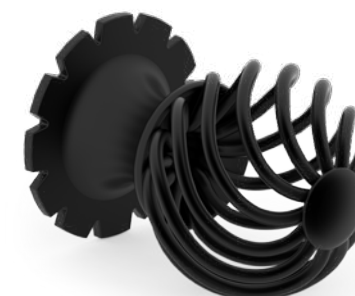

GAŁKA ROYAL BRAMOWA

CZARNY

Cena za 1 szt. w konfiguracji stałej*

	KOD	NETTO	BRUTTO
○	BGRC	50,79	62,47

* Pozostałe konfiguracje gatek; stałe, obrotowe oraz gałko-klamki dostępne na www.metal-bud.eu i na b2b.metal-bud.eu.



UCHWYT MAJA WEWNĄTRZKLATKOWY

PATYNA

STRONA/ ROZMIAR	KOD	NETTO	BRUTTO
◻ 72	VU7PL	81,27	99,96
◻72	VU7PP	81,27	99,96
◻ 90	VU9PL	81,27	99,96
◻90	VU9PP	81,27	99,96
◻ 92	VU92PL	91,43	112,45
◻92	VU92PP	91,43	112,45



UCHWYT MAJA WEWNĄTRZKLATKOWY

NIKIEL SZCZOTKOWANY

STRONA/ ROZMIAR	KOD	NETTO	BRUTTO
◻ 72	VU7NL	81,27	99,96
◻72	VU7NP	81,27	99,96
◻ 90	VU9NL	81,27	99,96
◻90	VU9NP	81,27	99,96
◻ 92	VU92NL	91,43	112,45
◻92	VU92NP	91,43	112,45



SZYLD GÓRNY MAJA ZEUS

	KOD	NETTO	BRUTTO
PATYNA	SZZP	20,32	24,99
NIKIEL SZCZOTKOWANY	SZZN	20,32	24,99



SZYLDY GÓRNE DŁUGIE TOTAL

SUPER CENA

Rozstaw
montażowy 105 mm.

	KOD	NETTO	BRUTTO
INOX PLUS	SGTDI	48,76	59,97
CZARNY	SGTDC	58,92	72,47
PATYNA F4	SGTDP	48,76	59,97



SZYLDY GÓRNE KRÓTKIE TOTAL

SUPER CENA

Rozstaw
montażowy 95 mm.

	KOD	NETTO	BRUTTO
INOX PLUS	SGTKI	48,76	59,97
CZARNY	SGTKC	58,92	72,47
PATYNA F4	SGTKP	48,76	59,97



SZYLDY DO ANTAB TOTAL

	KOD	NETTO	BRUTTO
INOX PLUS	SGTAKI	60,95	74,97
CZARNY	SGTAKC	77,20	94,96



SZYLDY MIRO

	KOD	NETTO	BRUTTO
NIKIEL SZCZOTKOWANY	SZMN	20,32	24,99
CZARNY	SZMCZ	24,38	29,99
PATYNA	SZMP	20,32	24,99



SZYLD GÓRNY METRO I TOPAZ

	KOD	NETTO	BRUTTO
STAL NIERDZEWNA	SGMDN	48,76	59,97



SZYLD DO ANTAB METRO I TOPAZ

	KOD	NETTO	BRUTTO
STAL NIERDZEWNA	SGMAN	67,05	82,47

ODBOJNIKI KWADRATOWE



		KOD	NETTO	BRUTTO
CZARNY	●	OKCZ	15,55	19,12
PATYNA	●	OKP	11,66	14,34
BIAŁY	○	OKBI	15,55	19,12
NIKIEL SATYNA	○	OKN	11,66	14,34
MOSIĄDZ SATYNA	●	OKM	11,66	14,34
CHROM	○	OKCH	13,60	16,73

ODBOJNIKI KLASYCZNE



		KOD	NETTO	BRUTTO
CHROM	○	ODS	9,33	11,47
MOSIĄDZ	●	ODM	9,33	11,47
PATYNA	●	ODP	9,33	11,47

ODBOJNIKI RETRO



		KOD	NETTO	BRUTTO
MOSIĄDZ	●	ODMR	9,13	11,23
PATYNA	●	ODPR	9,13	11,23
CHROM	○	ODCR	9,13	11,23

ODBOJNIKI NOWOCZESNE



		KOD	NETTO	BRUTTO
NIKIEL SATYNA	○	ONN	13,60	16,73
PATYNA	●	ONP	13,60	16,73
BIAŁY	○	ONBI	19,43	23,90
CZARNY	●	ONCZ	19,43	23,90
MOSIĄDZ	●	ONM	13,60	16,73
CHROM	○	ONCH	15,55	19,12

ODBOJNIKI PÓLKULISTE PRZYKLEJANE



		KOD	NETTO	BRUTTO
CZARNY	●	ODCZK	11,56	14,22
PATYNA	●	ODPK	9,62	11,83
BIAŁY	○	ODBIK	11,56	14,22
NIKIEL SATYNA	○	ODNK	9,62	11,83
MOSIĄDZ	●	ODMK	9,23	11,35
CHROM	○	ODCK	9,62	11,83

ODBOJNIKI PÓLKULISTE PRZYKRĘCANE



		KOD	NETTO	BRUTTO
PATYNA	●	ODPC	9,62	11,83
NIKIEL SATYNA	○	ODNC	9,62	11,83
BIAŁY	○	ODBIC	11,56	14,22
CZARNY	●	ODCZC	11,56	14,22
MOSIĄDZ	●	ODMC	9,23	11,35
CHROM	○	ODCC	9,62	11,83

ODBOJNIKI MAGNETYCZNE

SUPER CENA



		KOD	NETTO	BRUTTO
NIKIEL SATYNA	○	ODNM	16,32	20,08
PATYNA	●	ODPM	16,32	20,08
MOSIĄDZ SATYNA	●	ODSM	16,32	20,08

ODBOJNIKI WOLNOSTOJĄCE WYSOKIE



		KOD	NETTO	BRUTTO
NIKIEL SATYNA	○	ODWN	18,55	22,82
PATYNA	●	ODWP	18,55	22,82
CZARNY	●	ODWCZ	22,26	27,38

ODBOJNIKI WOLNOSTOJĄCE NISKIE



		KOD	NETTO	BRUTTO
CZARNY	●	ODNCZ	22,26	27,38
PATYNA	●	ODNP	18,55	22,82
NIKIEL SATYNA	○	ODNN	18,55	22,82

ODBOJNIKI PRZECZYSTY

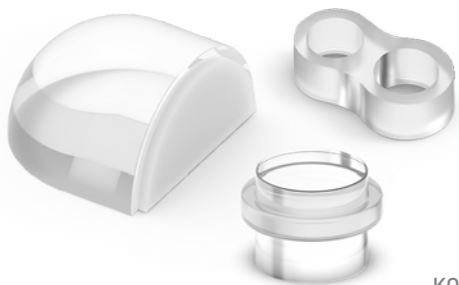

	KOD	NETTO	BRUTTO
ODBOJNIK PÓLKULA	ODAP	17,49	21,51
ODBOJNIK NA KLAMKĘ	OGKPR	3,05	3,75
ODBOJNIK WALEC	ODAW	18,46	22,71

ODBOJNIKI BUMMS

MAŁE 40 MM



	KOD	NETTO	BRUTTO
BIAŁY	OB4BI	3,66	4,50
BEŻ	OB4BE	3,66	4,50
BRĄZ	OB4BR	3,66	4,50

ODBOJNIKI BUMMS

DUŻE 60 MM



	KOD	NETTO	BRUTTO
BIAŁY	OB6BI	4,06	5,00
BEŻ	OB6BE	4,06	5,00
BRĄZ	OB6BR	4,06	5,00

STOPERY DRZWIOWE

SUPER CENA



	KOD	NETTO	BRUTTO
POMARAŃCZOWY	SLPO	9,72	11,95
CZERWONY	SLCZ	9,72	11,95
ŻÓŁTY	SLZO	9,72	11,95
ZIELONY	SLZI	9,72	11,95

WIZJERY DRZWIOWE

14 MM



	KOD	NETTO	BRUTTO
PATYNA	W14P	10,16	12,49
CHROM	W14C	10,16	12,49
CZARNY	W14CZ	12,19	14,99
MOSIĄDZ	W14M	10,16	12,49

WIZJERY DRZWIOWE

16 MM



	KOD	NETTO	BRUTTO
PATYNA	W16P	13,21	16,24
CHROM	W16C	13,21	16,24
MOSIĄDZ	W16M	13,21	16,24

WIZJERY ECO



	KOD	NETTO	BRUTTO
CHROM	HW14C	6,83	8,40
CZARN	HW14CZ	10,25	12,60

WIZJERY DRZWIOWE

27 MM, ZAKRES REGULACJI 40-70 MM



	KOD	NETTO	BRUTTO
CHROM	WD4C	30,48	37,48
GRAFIT	WD4G	30,48	37,48

WIZJERY DRZWIOWE

27 MM, ZAKRES REGULACJI 60-90 MM



	KOD	NETTO	BRUTTO
CHROM	WD6C	40,63	49,98
MOSIĄDZ	WD6M	40,63	49,98
GRAFIT	WD6G	40,63	49,98



ZESTAWY PROSTOKĄTNE

ZESTAW JEST KOMPLETNY, ZAWIERA:
 - ZAMEK HAKOWY NA KLUCZ Z BLACHĄ ZACZEPOWĄ*,
 - KLUCZ DO ZAMKA (1 SZT),
 - UCHWYTY OWALNE W WERSJI NA KLUCZ (2 SZT),
 - NAPARSTEK (1 SZT)

* ISTNIEJE MOŻLIWOŚĆ DOKUPIENIA DODATKOWEJ BLACHY DO OŚCIEŻNICY W CENIE 16,67 ZŁ NETTO (20,50 ZŁ BRUTTO) ZA SZTUKĘ

	KOD	NETTO	BRUTTO
CHROM	● ZPRKCB	140,19	172,43
MOSIĄDZ	● ZPRKMB	140,19	172,43
CHROM SZCZOTKOWANY	● ZPRKCS	136,12	167,43
CZARNY	● ZPRKCZ	140,19	172,43



UCHWYTY PROSTOKĄTNE

	KOD	NETTO	BRUTTO
CHROM	● UPRCB	36,57	44,98
MOSIĄDZ	● UPRMB	36,57	44,98
CHROM SZCZOTKOWANY	● UPRCS	36,57	44,98
CZARNY	● UPRCZ	36,57	44,98



ZESTAWY OWALNE

ZESTAW JEST KOMPLETNY, ZAWIERA:
 - ZAMEK HAKOWY NA KLUCZ Z BLACHĄ ZACZEPOWĄ*,
 - KLUCZ DO ZAMKA (1 SZT),
 - UCHWYTY OWALNE W WERSJI NA KLUCZ (2 SZT),
 - NAPARSTEK (1 SZT)

* ISTNIEJE MOŻLIWOŚĆ DOKUPIENIA DODATKOWEJ BLACHY DO OŚCIEŻNICY W CENIE 16,67 ZŁ NETTO (20,50 ZŁ BRUTTO) ZA SZTUKĘ

	KOD	NETTO	BRUTTO
CHROM	● ZOWKCB	119,87	147,44
MOSIĄDZ	● ZOWKMB	119,87	147,44
CHROM SZCZOTKOWANY	● ZOWKCS	115,81	142,44
CZARNY	● ZOWKCZ	119,87	147,44
NIKIEL SZCZOTKOWANY	● ZOWKN	111,74	137,44



UCHWYTY OWALNE

	KOD	NETTO	BRUTTO
CHROM	● UOWCB	28,44	34,99
MOSIĄDZ	● UOWMB	28,44	34,99
CHROM SZCZOTKOWANY	● UOWCS	26,41	32,49
CZARNY	● UOWCZ	28,44	34,99
NIKIEL SZCZOTKOWANY	● UOWN	24,38	29,99



ZESTAWY OKRĄGŁE

ZESTAW JEST KOMPLETNY, ZAWIERA:
 - ZAMEK HAKOWY NA KLUCZ Z BLACHĄ ZACZEPOWĄ*,
 - KLUCZ DO ZAMKA (1 SZT),
 - UCHWYTY OWALNE W WERSJI NA KLUCZ (2 SZT),
 - NAPARSTEK (1 SZT)

* ISTNIEJE MOŻLIWOŚĆ DOKUPIENIA DODATKOWEJ BLACHY DO OŚCIEŻNICY W CENIE 16,67 ZŁ NETTO (20,50 ZŁ BRUTTO) ZA SZTUKĘ

	KOD	NETTO	BRUTTO
CHROM	● ZOKKCB	97,52	119,95
MOSIĄDZ	● ZOKKMB	97,52	119,95
CHROM SZCZOTKOWANY	● ZOKKCS	93,46	114,95
CZARNY	● ZOKKCZ	97,52	119,95
NIKIEL SZCZOTKOWANY	● ZOKKN	91,43	112,45



UCHWYTY OKRĄGŁE

	KOD	NETTO	BRUTTO
CHROM	● UOKCB	26,41	32,49
MOSIĄDZ	● UOKMB	26,41	32,49
CHROM SZCZOTKOWANY	● UOKCS	24,38	29,99
CZARNY	● UOKCZ	26,41	32,49
NIKIEL SZCZOTKOWANY	● UOKN	22,35	27,49

UCHWYTY WPUSZCZANE ECO KWADRATOWE

SUPER CENA



	KOD	NETTO	BRUTTO
CHROM	UWNKC	15,77	19,39
MOSIĄDZ	UWNKM	15,77	19,39
NIKIEL SATYNA	UWNKN	15,77	19,39
PATYNA	UWNKP	15,77	19,39

UCHWYTY WPUSZCZANE ECO OKRĄGŁE

SUPER CENA



	KOD	NETTO	BRUTTO
CHROM	UWNOC	14,84	18,25
MOSIĄDZ	UWNOM	14,84	18,25
NIKIEL SATYNA	UWNON	14,84	18,25
PATYNA	UWNOP	14,84	18,25

UCHWYTY WPUSZCZANE ECO PROSTOKĄTNE

SUPER CENA



	KOD	NETTO	BRUTTO
MOSIĄDZ	UWPM	12,99	15,97
NIKIEL SATYNA	UWPN	12,99	15,97
PATYNA	UWPP	12,99	15,97

UCHWYTY WPUSZCZANE ECO OWALNE

SUPER CENA



	KOD	NETTO	BRUTTO
CHROM	UWCH	13,91	17,11
MOSIĄDZ	UWM	9,74	11,98
NIKIEL SATYNA	UWN	10,72	13,19
PATYNA	UWP	10,72	13,19

TULEJE WENTYLACYJNE OKRĄGŁE

SUPER CENA



	KOD	NETTO	BRUTTO
NIKIEL SATYNA	TNON40	15,55	19,12
CZARNY	TNOCZ40	27,21	33,46
BIAŁY	TNOBI40	27,21	33,46
PATYNA	TNOP40	15,55	19,12

	KOD	NETTO	BRUTTO
NIKIEL SATYNA	TNON34	15,55	19,12
CZARNY	TNOCZ34	27,21	33,46
BIAŁY	TNOBI34	27,21	33,46
PATYNA	TNOP34	15,55	19,12

TULEJE WENTYLACYJNE KWADRATOWE

SUPER CENA

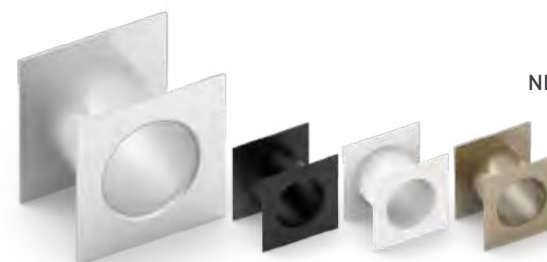

	KOD	NETTO	BRUTTO
NIKIEL SATYNA	TNN40	15,55	19,12
CZARNY	TNCZ40	27,21	33,46
BIAŁY	TNBI40	27,21	33,46
PATYNA	TNP40	15,55	19,12

	KOD	NETTO	BRUTTO
NIKIEL SATYNA	TNN34	15,55	19,12
CZARNY	TNCZ34	27,21	33,46
BIAŁY	TNBI34	27,21	33,46
PATYNA	TNP34	15,55	19,12

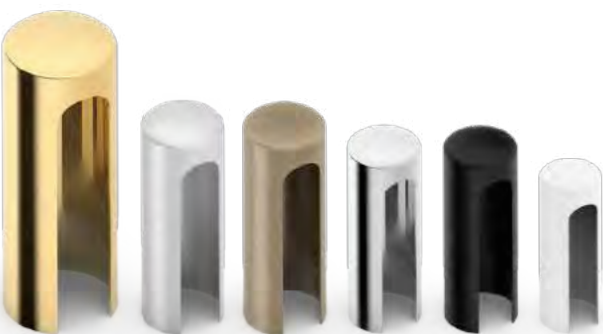

OSŁONKI DO ZAWIASÓW

		14 MM	15 MM	16 MM	20 MM
MOSIĄDZ	●	OZ14M	OZ15M	OZ16M	OZ20M
NIKIEL SATYNA	●	OZ14N	OZ15N	OZ16N	OZ20N
PATYNA	●	OZ14P	OZ15P	OZ16P	OZ20P
CHROM	●	OZ14C	OZ15C	OZ16C	OZ20C
		NETTO	BRUTTO	NETTO	BRUTTO
		2,84	3,50	3,05	3,75
		3,25	4,00	4,06	5,00
CZARNY	●	OZ14CZ	OZ15CM	OZ16CZ	OZ20CZ
BIAŁY	○	OZ14BI	OZ15BM	OZ16BI	OZ20BI
		NETTO	BRUTTO	NETTO	BRUTTO
		5,69	7,00	6,10	7,50
		6,50	8,00	8,13	10,00

OSŁONKA DO ZAWIASÓW RETRO



		KOD	NETTO	BRUTTO
PATYNA	●	OZ14PR	4,47	5,50

ZAWIASY REGULOWANE

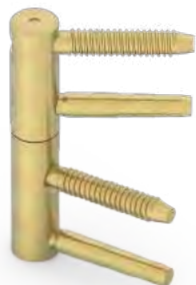

ROZMIAR	KOD	NETTO	BRUTTO
14 MM	ZR14	12,19	14,99
16 MM	ZR16	14,22	17,49
20 MM	ZR20	19,30	23,74

ZAPORNICE



		KOD	NETTO	BRUTTO
MOSIĄDZ	●	ZDM	16,25	19,99
CHROM	●	ZDC	16,25	19,99
PATYNA	●	ZDP	16,25	19,99

UCHWYTY DO PORĘCZY

SUPER CENA



		KOD	NETTO	BRUTTO
CHROM	●	UPC	23,32	28,68
MOSIĄDZ	●	UPM	21,38	26,29
NIKIEL SATYNA	●	UPN	23,32	28,68
PATYNA	●	UPP	23,32	28,68

ŚRUBY PRZELOTOWE



		DŁUGOŚĆ	KOD	NETTO	BRUTTO
MOSIĄDZ	●	80 MM	ZM	4,47	5,50
NIKIEL	●	80 MM	ZN	4,47	5,50
PATYNA	●	80 MM	ZP	4,47	5,50
NIKIEL	●	110 MM	ZN2	5,89	7,25
PATYNA	●	110 MM	ZP2	5,89	7,25
NIKIEL	●	6X6 MM	YSK	2,03	2,50

REDUKCJE



		ROZMIAR	KOD	NETTO	BRUTTO
PLASTIK	●	4/5 MM	R5	0,65	0,80
PLASTIK	●	4/6 MM	R6	0,65	0,80
PLASTIK	●	4/8 MM	R8	0,85	1,05
METAL OCYNKOWANY	●	8/9 MM	RM9	2,03	2,50
METAL OCYNKOWANY	●	8/10 MM	RM10	2,03	2,50

TRZPIENIE



		DŁUGOŚĆ	KOD	NETTO	BRUTTO
METAL OCYNKOWANY	●	12 CM	ZK12	2,03	2,50
METAL OCYNKOWANY	●	13 CM	ZK13	3,05	3,75
METAL OCYNKOWANY	●	14 CM	ZK14	3,05	3,75
METAL OCYNKOWANY	●	15 CM	ZK15	4,06	5,00
METAL OCYNKOWANY	●	16 CM	ZK16	4,06	5,00



	Q	Q	WC
CZARNY CHROM SZCZOTKOWANY MAT CHROM BŁYSZCZĄCY	● SZQSLCZK	SZQSLCZY	SZQSLCZW
	● SZQSLCMK	SZQSLCMY	SZQSLCMW
	● SZQSLCBK	SZQSLCBY	SZQSLCBW
	NETTO BRUTTO	NETTO BRUTTO	NETTO BRUTTO
	41,78 51,39	41,78 51,39	66,07 81,27
MOSIĄDZ SATYNOWANY MOSIĄDZ PVD	● SZQSLMSK	SZQSLMSY	SZQSLMSW
	● SZQSLMBK	SZQSLMBY	SZQSLMBW
	49,78 61,23	49,78 61,23	74,20 91,27



	Q	Q	WC
CZARNY NIKIEL SZCZOTKOWANY MAT CHROM SZCZOTKOWANY MAT CHROM BŁYSZCZĄCY	● SZQCZK	SZQCZY	SZQCZW
	● SZQNMK	SZQNMY	SZQNMW
	● SZQCMK	SZQCMY	SZQCMW
	● SZQCBK	SZQCBY	SZQCBW
	NETTO BRUTTO	NETTO BRUTTO	NETTO BRUTTO
	33,52 41,23	33,52 41,23	58,92 72,47
MOSIĄDZ PVD	● SZQMBK	SZQMBY	SZQMBW
	39,61 48,73	39,61 48,73	71,11 87,47
MIEDŹ PVD	● SZQRGK	SZQRGY	SZQRGW
	41,34 50,85	41,34 50,85	74,20 91,27



	Q	Q	WC
CHROM SZCZOTKOWANY MAT CHROM BŁYSZCZĄCY CZARNY	● SZOSLCMK	SZOSLCMY	SZOSLCMW
	● SZOSLCBK	SZOSLCBY	SZOSLCBW
	● SZOSLCZK	SZOSLCZY	SZOSLCZW
	NETTO BRUTTO	NETTO BRUTTO	NETTO BRUTTO
	41,78 51,39	41,78 51,39	66,07 81,27
MOSIĄDZ PVD MOSIĄDZ SATYNOWANY	● SZOSLMBK	SZOSLMBY	SZOSLMBW
	49,78 61,23	49,78 61,23	74,20 91,27

SZYLDY OKRĄGŁE R



	①	②	③
CZARNY ●	SZOCZK	SZOCZY	SZOCZW
CHROM SZCZOTKOWANY MAT ●	SZOCMK	SZOCMY	SZOCMW
CHROM BŁYSZCZĄCY ●	SZOCBK	SZOCBY	SZOCBW
	NETTO	BRUTTO	NETTO
	BRUTTO	NETTO	BRUTTO
	NETTO	BRUTTO	NETTO
	BRUTTO	NETTO	BRUTTO
MOSIĄDZ PVD ●	SZOMBK	SZOMBY	SZOMBW
	NETTO	BRUTTO	NETTO
	BRUTTO	NETTO	BRUTTO

SZYLDY OKRĄGŁE classic



	①	②	③
CHROM BŁYSZCZĄCY ●	SZOCLCBK	SZOCLCZY	SZOCLCBW
CZARNY ●	SZOCLCZK	SZOCLCZY	SZOCLCZW
	NETTO	BRUTTO	NETTO
	BRUTTO	NETTO	BRUTTO
	NETTO	BRUTTO	NETTO
	BRUTTO	NETTO	BRUTTO
MOSIĄDZ PVD ●	SZOCLMBK	SZOCLMBY	SZOCLMBW
	NETTO	BRUTTO	NETTO
	BRUTTO	NETTO	BRUTTO

SZYLDY KWADRATOWE K



	①	②	③
CZARNY ●	SZKCK	SZKCY	SZKCW
BIAŁY ○	SZKCK	SZKCY	SZKCW
	NETTO	BRUTTO	NETTO
	BRUTTO	NETTO	BRUTTO
	NETTO	BRUTTO	NETTO
	BRUTTO	NETTO	BRUTTO
NIKIEL SATYNA VELVET ●	SZKNVK	SZKNVY	SZKNVW
CHROM BŁYSZCZĄCY ●	SZKCBK	SZKCBY	SZKCBW
	NETTO	BRUTTO	NETTO
	BRUTTO	NETTO	BRUTTO
	NETTO	BRUTTO	NETTO
	BRUTTO	NETTO	BRUTTO
MOSIĄDZ BŁYSZCZĄCY ●	SZKMBK	SZKMBY	SZKMBW
	NETTO	BRUTTO	NETTO
	BRUTTO	NETTO	BRUTTO
	NETTO	BRUTTO	NETTO
	BRUTTO	NETTO	BRUTTO
NIKIEL SZCZOTKOWANY ●	SZKNSK	SZKNSY	SZKNSW
	NETTO	BRUTTO	NETTO
	BRUTTO	NETTO	BRUTTO

DO KLAMEK LUNA R, JULIA R, GAŁKA R

DO KLAMEK OLIVIA R CLASSIC, LAURA R CLASSIC

DO KLAMEK IBIZA K, RUMBA K, BARCELONA K,
QUBIK K, FOXS K

DO KLAMEK QUBIK K FIT, QUANTA K FIT

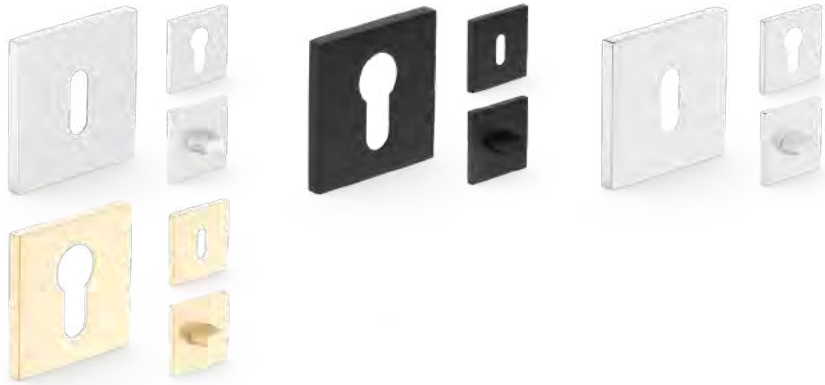

DO KLAMEK LINEA, ISKRA, TREND, DUO, IBIZA, RIO, MONDO, VIVA, FIESTA, DARO, PRIMA, CAMILA, GÁLKÁ, DECO



DO KLAMEK ASTRA, SYDNEY, LIBRA, BLANKA, ZORBA, DIANA, DARO, PLEJADA, NICOLE, CAMILA, IDEA, RICCO, ARTEMIDA, FEBE, ORION



SZYLDY KWADRATOWE K FIT

	0	0	WC				
NIKIEL SZCZOTKOWANY	●	SZKFINSK	SZKFINSY	SZKFINSW			
CZARNY	●	SZKFICZK	SZKFICZY	SZKFICZW			
CHROM BŁYSZCZĄCY	●	SZKFICBK	SZKFICBY	SZKFICBW			
MOSIĄDZ BŁYSZCZĄCY	●	SZKFIMSK	SZKFIMSY	SZKFIMSW			
		NETTO	BRUTTO	NETTO	BRUTTO	NETTO	BRUTTO
		31,71	39,00	31,71	39,00	43,90	54,00

SZYLDY KWADRATOWE ZAOKRĄGLONE

	0	0	WC	□			
NIKIEL SZCZOTKOWANY	●	SZZNK	SZZNY	SZZNW	SZZNB		
CHROM BŁYSZCZĄCY	●	SZZCK	SZZCY	SZZCW			
PATYNA	●	SZZPK	SZZPY	SZZPW	SZZPB		
NIKIEL/SATYNA	●	SZZSNK	SZZSNY	SZZSNW			
		NETTO	BRUTTO	NETTO	BRUTTO	NETTO	BRUTTO
		22,57	27,76	22,57	27,76	33,87	41,66
		22,57	27,76	33,87	41,66	22,57	27,76
GRAFIT/CHROM	●	SZZGK	SZZGY	SZZGW			
		24,60	30,26	24,60	30,26	35,90	44,16

SZYLDY OKRĄGŁE

	0	0	WC	○			
NIKIEL SZCZOTKOWANY	●	SNOSK	SNOSY	SNOSW	SNOSB		
CZARNY	●	SNOCZK	SNOCZY	SNOCZW			
CHROM/SATYNA	●	TNOCK	TNOCY	TNOCW			
CHROM BŁYSZCZĄCY	●	SNOCHK	SNOCHY	SNOCHW			
PATYNA	●	SNOPK	SNOPY	SNOPW	SNOPB		
		NETTO	BRUTTO	NETTO	BRUTTO	NETTO	BRUTTO
		14,22	17,49	14,22	17,49	24,38	29,99
		14,22	17,49	24,38	29,99	14,22	17,49

SZYLDY KWADRATOWE



	□	⊕	WC	□
NIKIEL/SATYNA	SZKNK	SZKNY	SZKNW	SZKNB
PATYNA	SZKPK	SZKPY	SZKPW	SZKPB
	NETTO	BRUTTO	NETTO	BRUTTO
	20,32	24,99	20,32	24,99
	30,48	37,48	20,32	24,99

SZYLDY KWADRATOWE Z KOŁEM

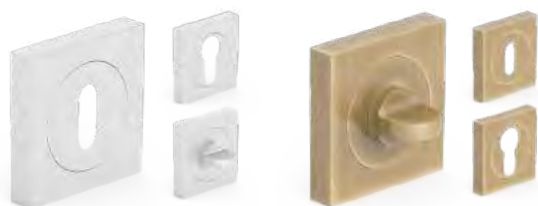

	□	⊕	WC
NIKIEL SZCZOTKOWANY	VSKNK	VSKNY	VSKNW
PATYNA	VSKPK	VSKPY	VSKPW
	NETTO	BRUTTO	NETTO
	17,27	21,24	17,27
	21,24	28,44	34,99

SZYLDY OKRĄGŁE



	⊕	⊕	WC
NIKIEL ANTYCZNY	SNONAK	SNONAY	SNONAW
	NETTO	BRUTTO	NETTO
	34,54	42,48	34,54
	42,48	58,92	72,47
PATYNA ANTYCZNA	SNOPAK	SNOPAY	SNOPAW
	NETTO	BRUTTO	NETTO
	28,44	34,99	28,44
	34,99	50,79	62,47

SZYLDY OKRĄGŁE ZE STALI NIERDZEWNEJ 3S



	⊕	⊕	WC
STAL NIERDZEWNA	NNK3S	NNY3S	NNWC3S
	NETTO	BRUTTO	NETTO
	38,87	47,81	38,87
	47,81	58,30	71,71
CZARNY	NNKC3S	NNYC3S	NNWC3S
	NETTO	BRUTTO	NETTO
	48,58	59,76	48,58
	59,76	68,02	83,66

SZYLDY KWADRATOWE ZE STALI NIERDZEWNEJ 3S



	□	⊕	WC
STAL NIERDZEWNA	SSKK3S	SSKY3S	SSKW3S
	NETTO	BRUTTO	NETTO
	48,58	59,76	48,58
	59,76	68,02	83,66
CZARNY	SSKKC3S	SSKYC3S	SSKWC3S
	NETTO	BRUTTO	NETTO
	58,30	71,71	58,30
	71,71	77,73	95,61

DO KLAMEK ALFA, GAMA, EUROPA, PLEADA, BETA

DO KLAMEK QUBIK, ASTRA

DO KLAMEK TOSCA, CHIARA

DO KLAMEK TOPAZ 3S, NOVA 3S

DO KLAMEK TOPAZ 3S, NOVA 3S

DO KLAMEK LOWISZ, NEPTUN, DOMINO, ROMA, PANDORA,
METRO, ELEKTRA, PROXIMA, NOVA, LEDA, GAŁKA

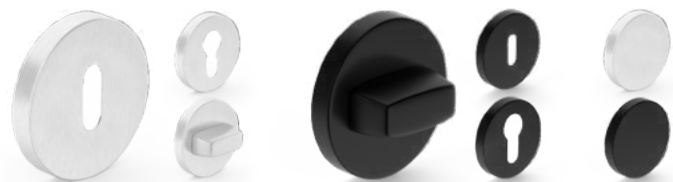

	①	②	WC	○
STAL NIERDZEWNA ●	NNK	NNY	NNWC	NNB
	NETTO BRUTTO	NETTO BRUTTO	NETTO BRUTTO	NETTO BRUTTO
	10,60 13,04	10,60 13,04	24,80 30,51	10,60 13,04
CZARNY ●	NNKPC	NNYPC	NNWPC	NNBPC
	21,20 26,08	21,20 26,08	45,93 56,50	21,20 26,08

DO KLAMEK TOPAZ, ONYX, ROMA, STEREO, PANDORA,
METRO, ELEKTRA, PROXIMA, NOVA, LEDA, GAŁKA



SZYLDY KWADRATOWE ZE STALI NIERDZEWNEJ

	①	②	WC	□
STAL NIERDZEWNA ●	SSKK	SSKY	SSKW	SSB
	NETTO BRUTTO	NETTO BRUTTO	NETTO BRUTTO	NETTO BRUTTO
	15,26 18,77	15,26 18,77	31,48 38,72	16,25 19,99
CZARNY ●	SSKKMC	SSKYM	SSKWMC	SSBMC
	31,09 38,24	31,09 38,24	58,30 71,71	32,51 39,98
BIAŁY ○	SSKKMB	SSKYMB	SSKWMB	SSBMB
	28,18 34,66	28,18 34,66	53,00 65,19	29,46 36,23

DO KLAMEK BETA, EUROPA, GAŁKA



	①
PATYNA ●	SZBKPD
NIKIEL ○	SZBKND
	NETTO BRUTTO
	26,41 32,49

DO KLAMEK NICOLE, ORION, LIBRA, IDEA, DIANA



	①
PATYNA ●	SBOP
NIKIEL ○	SBON
	NETTO BRUTTO
	14,22 17,49

DO KLAMEK PRIMA, VIVA, MONDO, FIESTA, GAŁKA



	①
PATYNA ●	SZZKP
NIKIEL ○	SZZKN
	NETTO BRUTTO
	20,32 24,99

DO KLAMEK ZORBA, PLEJADA, EVA



	①
PATYNA ●	VSBOP
CHROM/SATYNA ○	VSBON
	NETTO BRUTTO
	14,22 17,49

SZYLDY GÓRNE

AKCESORIA

WKŁADKI



WYMIARY	NETTO	BRUTTO
N26/36	21,54	26,49
N26/41	26,44	32,52
N26/46	28,54	35,10
N30/30	21,54	26,49
N30/35	24,34	29,94
N30/40	25,74	31,66
N30/45	27,71	34,08
N30/50	29,11	35,80
N30/55	33,43	41,12
N35/35	26,86	33,04
N35/40	27,71	34,08
N40/40	29,66	36,48
N35/45	29,66	36,48
N35/50	30,63	37,68
N35/55	32,46	39,92
N40/45	29,26	35,98
N40/50	32,46	39,92
N40/55	34,70	42,69
N40/60	35,26	43,36
N40/65	35,83	44,07
N45/45	32,46	39,92
N45/50	33,86	41,64
N45/55	35,26	43,36
N45/60	39,58	48,68
N45/65	40,85	50,25
N50/50	35,26	43,36
N50/55	36,65	45,09

NIKIEL

3 KLUCZE W KOMPLECIE



NIKIEL

3 KLUCZE W KOMPLECIE

WKŁADKI Z GAŁKĄ

WYMIARY	NETTO	BRUTTO
S26/36	29,93	36,82
S36/26	29,93	36,82
S26/41	34,83	42,84
S41/26	34,83	42,84
S30/30	29,93	36,82
S30/35	32,73	40,26
S35/30	32,73	40,26
S30/40	34,13	41,98
S40/30	34,13	41,98
S30/45	36,10	44,41
S45/30	36,10	44,41
S30/50	37,50	46,13
S50/30	37,50	46,13
S30/55	39,03	48,01
S55/30	37,27	45,84
S35/35	35,26	43,36
S35/40	34,47	42,40
S40/35	34,47	42,40
S40/40	34,60	42,56
S35/45	37,10	45,63
S45/35	38,05	46,81
S35/50	39,03	48,01
S50/35	39,03	48,01
S35/55	40,85	50,25
S55/35	37,14	45,69
S40/45	35,49	43,65
S45/40	35,49	43,65
S40/50	40,85	50,25
S50/40	40,85	50,25
S45/45	40,85	50,25
S45/50	42,25	51,97
S50/45	42,25	51,97
S40/55	42,25	51,97
S55/40	42,25	51,97
S40/65	46,92	57,71
S65/40	46,92	57,71
S45/55	44,58	54,84
S55/45	44,58	54,84
S45/60	48,91	60,16
S60/45	48,91	60,16
S45/65	52,05	64,02
S65/45	52,05	64,02
S50/55	46,92	57,71
S55/50	46,92	57,71

WKŁADKI



WYMIARY	NETTO	BRUTTO
C2030	57,24	70,41
C2636	60,77	74,75
C3030	48,04	59,08
C3035	57,24	70,41
C3040	66,43	81,71

CZARNY

3 KLUCZE W KOMPLECIE

WKŁADKI Z GAŁKĄ



WYMIARY	NETTO	BRUTTO
D2030	78,44	96,48
D2636	81,97	100,83
D3626	81,97	100,83
D3030	69,24	85,16
D3035	78,44	96,48
D3530	78,44	96,48
D3040	87,63	107,79
D4030	87,63	107,79

CZARNY

3 KLUCZE W KOMPLECIE

KOMPLET WKŁADEK



CZARNY

3 KLUCZE W KOMPLECIE

WYMIARY	NETTO	BRUTTO
ZC3040	141,10	178,48
ZC4030	141,10	178,48

WKŁADKI

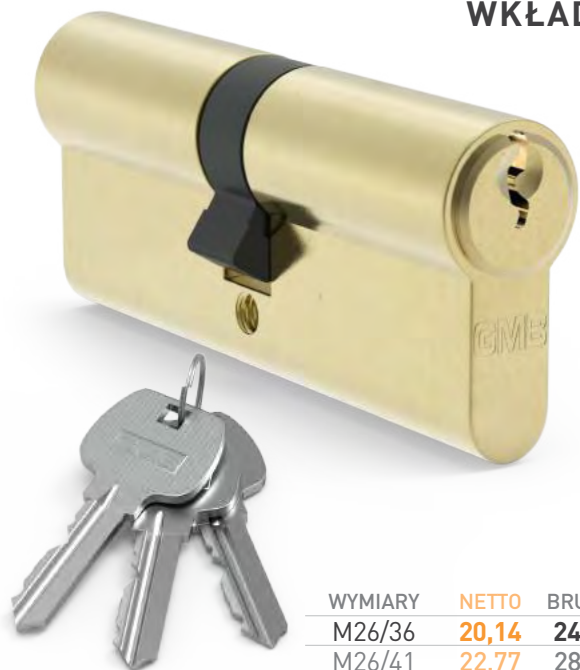

WYMIARY	NETTO	BRUTTO
M26/36	20,14	24,77
M26/41	22,77	28,01
M26/46	27,14	33,38
M30/30	20,14	24,77
M30/35	22,94	28,21
M30/40	24,34	29,94
M30/45	26,31	32,36
M30/50	27,71	34,08
M30/55	28,96	35,62
M35/40	26,31	32,36
M40/40	29,23	35,96
M35/45	29,23	35,96
M35/35	25,46	31,32
M35/50	29,23	35,96
M35/55	31,06	38,20
M40/45	29,23	35,96
M40/50	31,06	38,20
M40/55	32,46	39,92
M40/60	33,86	41,64
M40/65	34,83	42,84
M45/45	28,24	34,73
M45/50	32,46	39,92
M45/55	33,86	41,64
M45/60	31,67	38,96
M50/50	30,78	37,86
M50/55	31,67	38,96
M55/55	35,83	44,07

MOSIĄDZ SATYNA
3 KLUCZE W KOMPLECIE



MOSIĄDZ SATYNA
3 KLUCZE W KOMPLECIE

WKŁADKI Z GAŁKĄ

WYMIARY	NETTO	BRUTTO
G26/36	25,95	31,92
G36/26	25,95	31,92
G30/30	25,95	31,92
G30/35	28,49	35,05
G35/30	28,49	35,05
G30/40	29,76	36,61
G40/30	29,76	36,61
G30/45	34,70	42,69
G45/30	34,70	42,69
G30/50	32,82	40,37
G50/30	36,10	44,41
G30/55	34,22	42,09
G55/30	34,22	42,09
G35/40	31,55	38,80
G40/35	31,55	38,80
G40/40	34,22	42,09
G35/45	34,22	42,09
G45/35	34,22	42,09
G35/35	33,86	41,64
G35/50	34,22	42,09
G50/35	34,22	42,09
G35/55	35,87	44,12
G55/35	35,87	44,12
G40/45	34,22	42,09
G45/40	34,22	42,09
G40/50	35,87	44,12
G50/40	35,87	44,12
G45/45	35,87	44,12
G45/50	37,14	45,69
G50/45	37,14	45,69
G40/55	40,85	50,25
G55/40	40,85	50,25
G40/65	45,52	55,99
G65/40	41,38	50,90
G45/55	43,18	53,12
G55/45	39,26	48,29
G50/50	43,18	53,12



MOSIĄDZ SATYNA
5 KLUCZY W KOMPLECIE



MOSIĄDZ SATYNA
5 KLUCZY W KOMPLECIE



NIKIEL
5 KLUCZY W KOMPLECIE

WKŁADKI NAWIERCANE



WYMIARY	NETTO	BRUTTO
NM30/30	33,03	40,63
NM30/35	35,26	43,36
NM30/40	36,23	44,56

WKŁADKI Z GAŁKĄ NAWIERCANE



WYMIARY	NETTO	BRUTTO
H30/30	37,65	46,31
H30/35	39,69	48,81
H35/30	43,65	53,69
H30/40	40,58	49,91
H40/30	40,58	49,91

ZESTAW WKŁADEK NAWIERCANE

WYMIARY	NETTO	BRUTTO
ZN25/50	87,45	107,56
ZN50/25	87,45	107,56

KOMPLET WKŁADEK

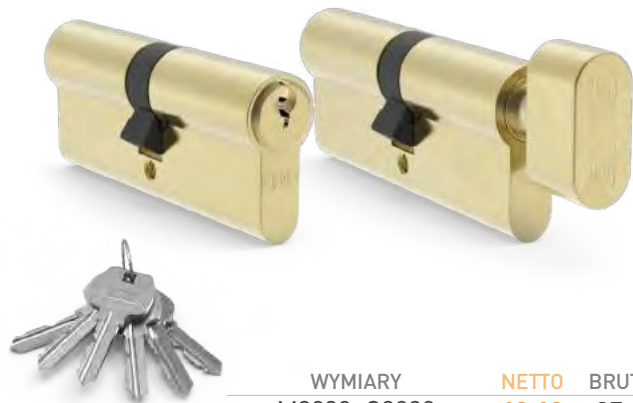

WYMIARY	NETTO	BRUTTO
M3030+G3030	69,18	85,09
M3035+G3035	72,29	88,92
M3035+G3530	72,29	88,92
M3040+G3040	75,40	92,74
M3040+G4030	75,40	92,74
M3045+G3045	78,51	96,57
M3045+G4530	78,51	96,57
M3050+G3050	81,62	100,39
M3050+G5030	81,62	100,39
M3055+G3055	84,73	104,22
M3055+G5530	84,73	104,22
M3535+G3535	69,18	85,09
M3545+G3545	81,62	100,39
M3545+G4535	81,62	100,39
M3550+G3550	84,73	104,22
M3550+G5035	84,73	104,22
M3555+G3555	90,95	111,87
M3555+G5535	90,95	111,87
M4050+G4050	87,84	108,04
M4050+G5040	87,84	108,04
M4055+G4055	90,95	111,87
M4055+G5540	90,95	111,87
M4550+G4550	94,06	115,69
M4550+G5045	94,06	115,69
M4555+G4555	97,17	119,52
M4555+G5545	97,17	119,52
M5050+G5050	97,17	119,52
M4065+G4065	100,28	123,34
M4065+G6540	100,28	123,34
M4565+G4565	109,22	134,33
M4565+G6545	109,22	134,33
M5060+G5060	109,22	134,33
M5060+G6050	109,22	134,33

MOSIĄDZ SATYNA
6 KLUCZY
W KOMPLECIE

KOMPLET WKŁADEK



WYMIARY	NETTO	BRUTTO
N3030+S3030	73,59	90,52
N3035+S3035	76,70	94,35
N3035+S3530	76,70	94,35
N3040+S3040	79,81	98,17
N3040+S4030	79,81	98,17
N3045+S3045	82,92	101,99
N3045+S4530	82,92	101,99
N3050+S3050	86,03	105,82
N3050+S5030	86,03	105,82
N3535+S3535	79,81	98,17
N3550+S3550	89,14	109,64
N3550+S5035	89,14	109,64
N3545+S3545	86,03	105,82
N3545+S4535	86,03	105,82
N3555+S3555	92,25	113,47
N3555+S5535	92,25	113,47
N4050+S4050	92,25	113,47
N4050+S5040	92,25	113,47
N4055+S4055	95,36	117,29
N4055+S5540	95,36	117,29
N4550+S4550	96,58	118,80
N4550+S5045	96,58	118,80
N4555+S4555	98,47	121,12
N4555+S5545	98,47	121,12
N5050+S5050	98,47	121,12
N4065+S4065	101,58	124,94
N4065+S6540	101,58	124,94
N4560+S4560	106,24	130,68
N4560+S6045	106,24	130,68
N4565+S4565	110,52	135,94
N4565+S6545	110,52	135,94
N5055+S5055	101,58	124,94
N5055+S5550	101,58	124,94
N5060+S5060	110,52	135,94
N5060+S6050	110,52	135,94
N5555+S5555	104,69	128,77

NIKIEL SATYNA
6 KLUCZY
W KOMPLECIE

WKŁADKI INWESTYCYJNE

SUPER CENA



WYMIARY	NETTO	BRUTTO
NA26/36	14,89	18,31
NA30/30	14,89	18,31
NA30/35	16,67	20,51
NA30/40	17,57	21,61
NA30/50	19,72	24,26
NA40/55	24,39	30,00

NIKIEL SATYNA
3 KLUCZE W KOMPLECIE

WKŁADKI Z GAŁKĄ INWESTYCYJNE

SUPER CENA



WYMIARY	NETTO	BRUTTO
SA30/40	22,95	28,23
SA40/30	21,05	25,89
SA30/50	25,11	30,88
SA50/30	25,11	30,88
SA40/55	30,12	37,05
SA55/40	30,12	37,05

NIKIEL SATYNA
3 KLUCZE W KOMPLECIE

WKŁADKI POŁÓWKOWE



NIKIEL
3 KLUCZE W KOMPLECIE

WYMIARY	NETTO	BRUTTO
N9/55	31,38	38,59
N9/70	35,66	43,86

WKŁADKI

SUPER CENA



WYMIARY	NETTO	BRUTTO
P26/36	17,95	22,08
P26/41	22,03	27,10
P26/46	21,62	26,60
P30/30	17,95	22,08
P30/35	20,28	24,95
P30/40	21,45	26,38
P30/45	23,09	28,40
P30/50	24,26	29,84
P30/55	23,21	28,55
P35/35	22,38	27,53
P35/40	20,99	25,82
P40/40	22,47	27,64
P35/45	24,72	30,40
P35/50	23,21	28,55
P35/55	24,59	30,25
P40/45	23,21	28,55
P40/50	27,05	33,27
P40/55	28,21	34,70
P45/45	24,59	30,25
P45/50	25,65	31,55
P45/55	29,38	36,14

PATYNA

3 KLUCZE W KOMPLECIE

WKŁADKI Z GAŁKĄ

SUPER CENA



WYMIARY	NETTO	BRUTTO
B26/36	22,68	27,90
B36/26	22,68	27,90
B26/41	26,39	32,46
B41/26	29,03	35,70
B30/30	24,95	30,68
B30/35	27,28	33,55
B35/30	27,28	33,55
B30/40	28,44	34,99
B40/30	28,44	34,99
B30/45	27,35	33,64
B45/30	30,09	37,01
B30/50	31,25	38,44
B50/30	28,41	34,94
B35/35	29,38	36,14
B35/40	27,35	33,64
B40/35	27,35	33,64
B40/40	28,83	35,46
B35/45	28,83	35,46
B45/35	28,83	35,46
B35/50	29,57	36,38
B50/35	29,57	36,38
B40/45	29,57	36,38
B45/40	29,57	36,38
B40/50	34,04	41,87
B50/40	30,95	38,07
B45/45	30,95	38,07
B45/50	32,01	39,37
B50/45	32,01	39,37

PATYNA

3 KLUCZE W KOMPLECIE

KLUCZE SUROWE



PROFILOWANY
NAWIERCANY

KOD	NETTO	BRUTTO
KPGMB	3,18	3,91
KNGMB	5,30	6,52

WKŁADKI Z GAŁKĄ

INWESTYCYJNE

SUPER CENA



MOSIĄDZ

ALUMINIOWY

3 KLUCZE W KOMPLECIE

WYMIARY	NETTO	BRUTTO
GA30/40	21,05	25,89
GA40/30	21,05	25,89
GA30/50	25,11	30,88
GA50/30	25,11	30,88

WKŁADKI

INWESTYCYJNE

SUPER CENA



MOSIĄDZ

ALUMINIOWY

3 KLUCZE W KOMPLECIE

WYMIARY	NETTO	BRUTTO
MA26/36	13,70	16,85
MA30/30	14,89	18,31
MA30/35	16,67	20,51
MA30/40	16,15	19,86
MA30/50	19,72	24,26

SZABLON MONTAŻOWY

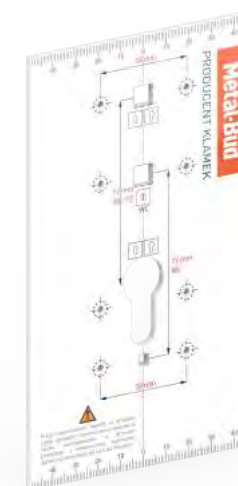

KOD	NETTO	BRUTTO
SZABK	25,00	30,75

STOJAK NOWOCZESNY

MODELE KLAMEK NA SZAFACH I STOJAKACH SĄ USTALANE
INDYWIDUALNIE Z KLIENTEM



170 CM x 32 CM

STOJAK PREMIUM



170 CM x 50 CM

EKSPOZYTOR ŚCIENNY



100 CM x 40 CM*

EKSPOZYTOR ŚCIENNY



118 CM x 20 CM*

SZAFA SZEROKA



120 CM x 187 CM x 50 CM
szerokość wysokość głębokość

SZAFA WĄSKA



55 CM x 187 CM x 60 CM
szerokość wysokość głębokość

Niniejszy katalog produktów nie stanowi oferty w rozumieniu przepisów Kodeksu Cywilnego, ani zapewnienia w rozumieniu przepisu art. 4 ustawy z dnia 27.07.2002 r. o szczególnych warunkach sprzedaży konsumenckiej. Firma METAL-BUD zastrzega sobie prawo wprowadzenia (bez uprzedzenia) zmian parametrów technicznych, wyposażenia, cen, warunków wydłużonej gwarancji oraz specyfikacji produktów. Wszystkie ceny, zawarte w niniejszym Katalogu, stanowią średnie rynkowe ceny detaliczne produktów, określone na podstawie wybranej próbki transakcji dokonywanych przez dealerów i Autoryzowane Punkty Sprzedaży (APS). Ceny w Katalogu podane są w PLN.

Niniejszy Katalog nie ustala cen odsprzedaży, zaś poszczególni dealerzy i APS indywidualnie określają ceny produktów METAL-BUD, w związku z czym ceny sprzedaży mogą się różnić w poszczególnych punktach sprzedaży. Zawarte informacje są aktualne w chwili ukazania się niniejszej publikacji. Wszystkie poprzednie cenniki dotyczące tego samego asortymentu tracą ważność. Aktualne ceny i szczegółowa oferta dostępna również na www.metal-bud.eu

UWAGA! Ze względu na użytą technikę druku kolor prezentowanego produktu może różnić się od oryginału.



METAL-BUD
ul. Bielowicza 76
32-040 Świątniki Górne
woj. małopolskie, Polska

E : biuro@metal-bud.eu
T : 12 444 66 00
M : 601 820 959
502 264 995
F : 12 270 50 20

Dyrektor Handlowy : 601 820 951

www.metal-bud.eu