

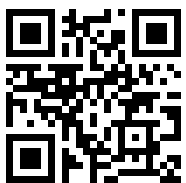

**Arbiton**  
FLOOR EXPERT

2022



[www.arbiton.com](http://www.arbiton.com)

# SKIRTING BOARDS

# MORE THAN... **JUST SKIRTING BOARDS**

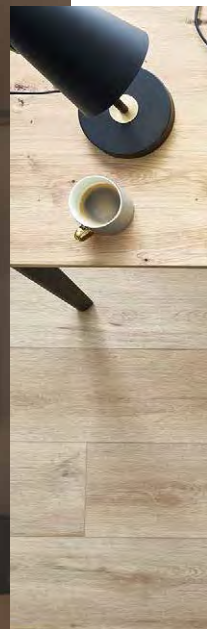

**WE CREATE**

**WE TEST**

**WE PRODUCE**

Innovation, quality and know-how. Since 1994 we've been investing in knowledge, technology and our machinery park.

We aim to become market LEADER wherever we are present. We push forward and strive for more to deliver accessories perfectly matched to the products.

**WE TRY HARDER, WE ARE  
THE FLOOR EXPERT**







## TECHNOLOGY

Our inhouse laboratory is testing hundreds of floors from all major manufacturers to improve our accessories and create a functional flooring system. That's why we know the strongest and weakest points of all types of floors. We also test our underlays to deliver top quality solutions for different floor types.

## DESIGN

Every year A.DESIGN STUDIO analyzes trends, changes in consumer preferences and hundreds of new floor colors. That's why we can create customer orientated solutions and stay relevant.

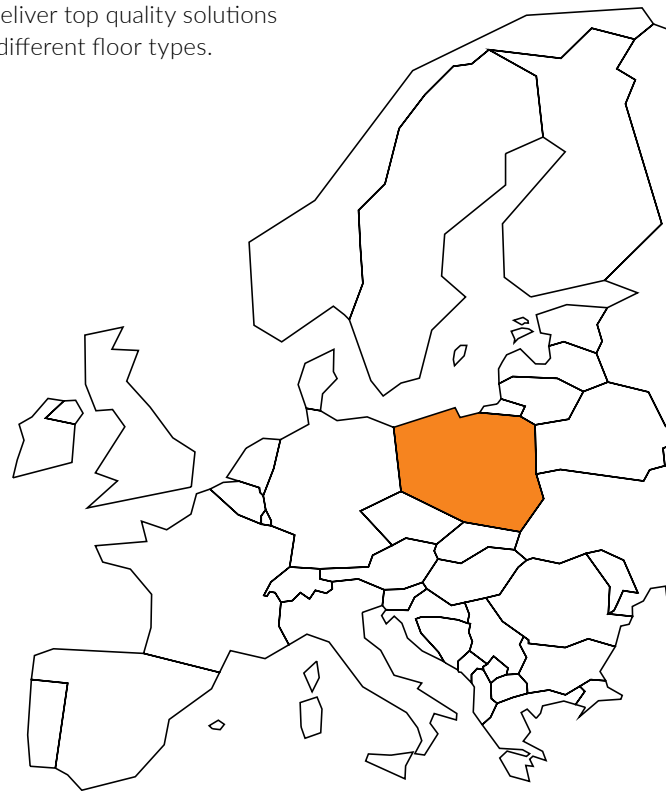

## MANUFACTURE

We are an European leader for production of floor accessories. Our technological development allows us to offer great portfolio of products in various technologies.

TORE | 05 Black



TORE | 01 White



## NEW COLLECTIONS

We do not limit ourselves and stop pushing towards innovation. That is what drives us to create new products. Initially we have set an ambitious goal for our new skirting board.

5 new colors

**NEW**

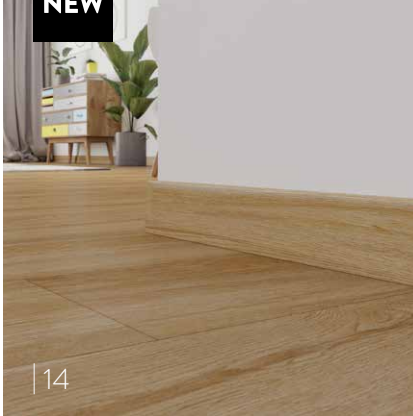

| 14

**TORE** ●

**NEW**



| 14

**TORE MONOCOLOR** ●

2 new colors

8 new colors

**NEW**

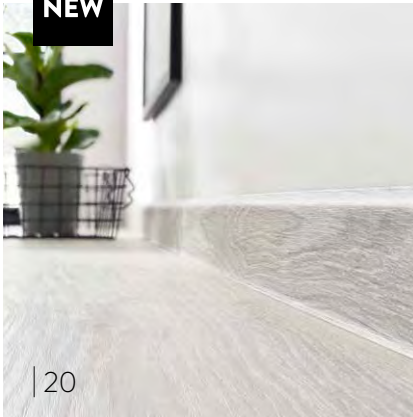

| 20

**VIGO 60** ●

**NEW**

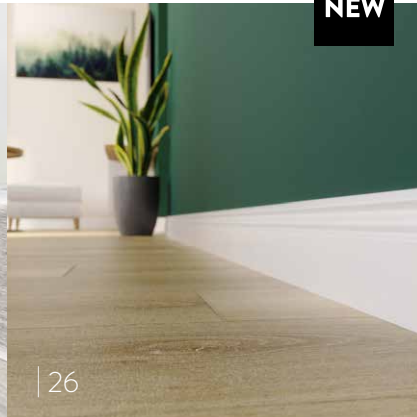

| 26

**STIQ XL** ●

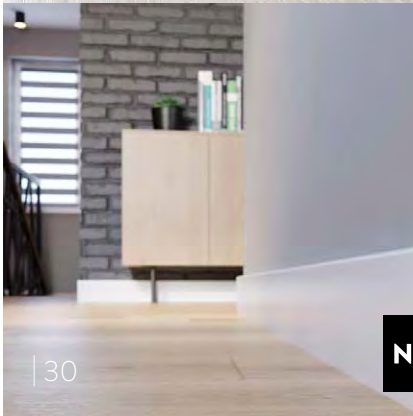

| 30

**NEW**

**STIQ+** ●



# TABLE OF CONTENT



## SOLID CORE



## NON-PVC WATERPROOF

INDO ●

LARS ●

MACK ●

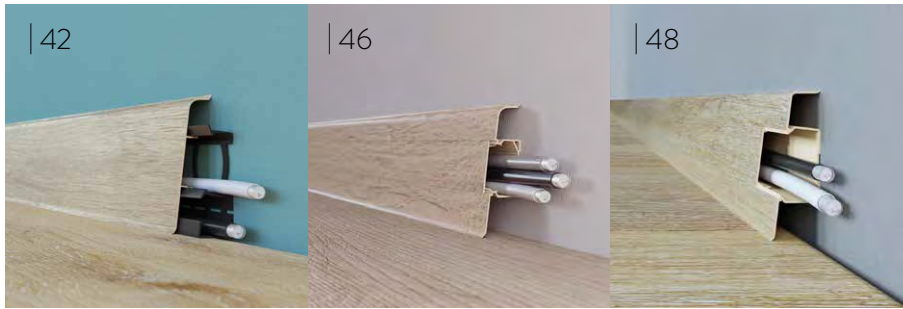

### MODERN PVC

LM60 ●

LM55 ●



### TRADITIONAL PVC

PAINT-IT ●

DIAMOND ●



### TRADITIONAL MDF

UNIVERSAL PROFILES

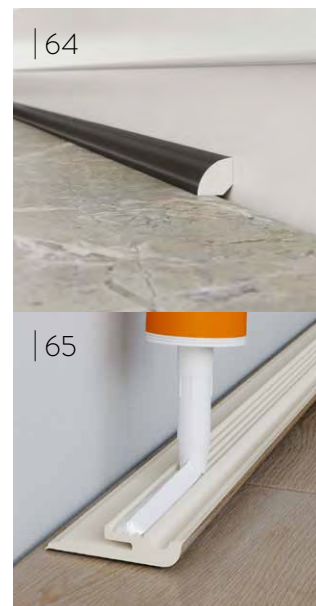

ACCESSORIES

SKIRTING BOARDS

**SOLID CORE**  
COLLECTIONS







TORE  
VIGO 60  
VIGO 80

SOLID  
CORE

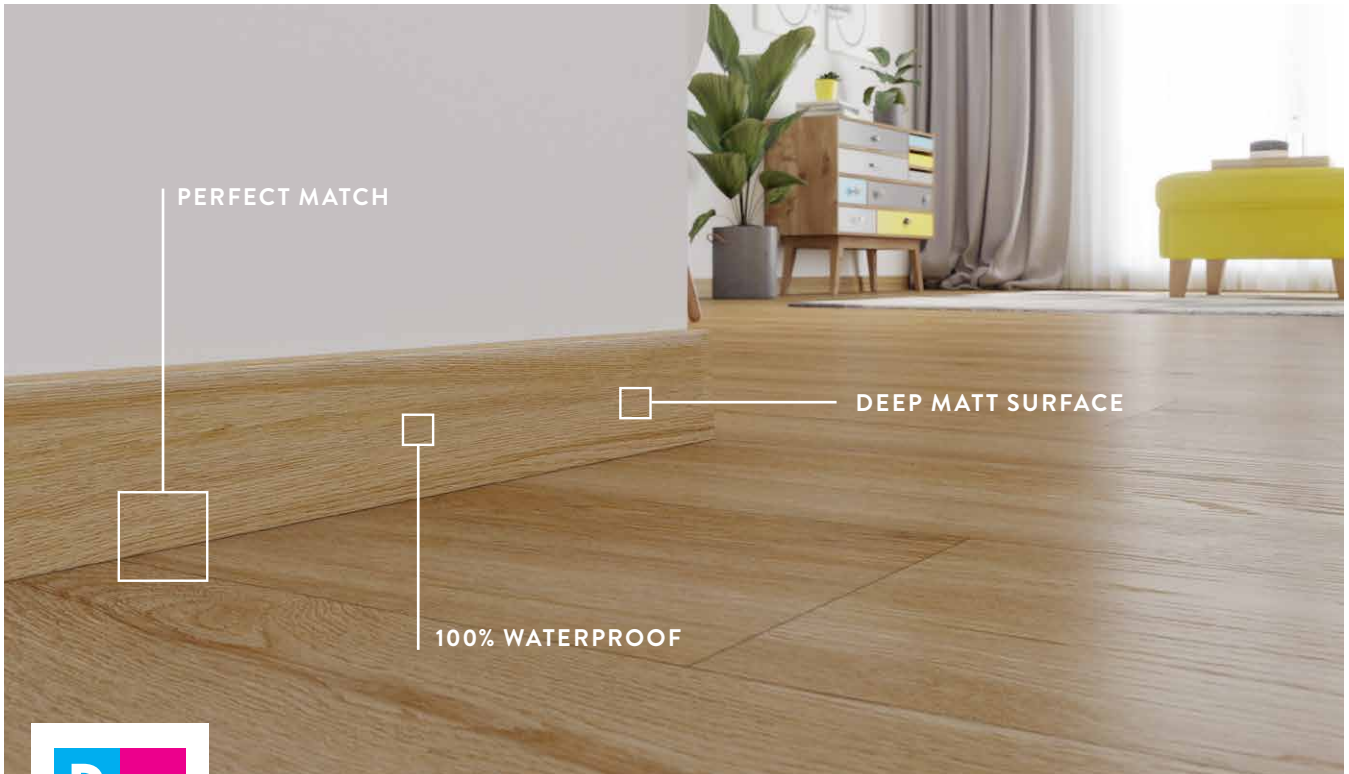

## TORE

### SOLID CORE SKIRTING BOARDS

TORE is our new hybrid skirting board produced in a brand new technology giving it a 100% water resistance as well as a higher abrasion resistance. Due to the highly advanced technology of digital printing - piezoelectric UV LED with high-resolution (up to 1800 dpi), we gained an unprecedented fidelity to raw materials at the surface of the skirtings boards, which now look like actual wood, stone or concrete. It allowed us to ideally match design of the skirtings not only with our floors but also with the most popular designs on the market.

With a multistep process of production TORE gains a perfect matte surface. As a result, skirtings boards obtain a deep thread design enriching each interior and underlining its beauty.

More importantly, used technologies provide the resistance to UV light - the design of the skirtings stays protected for years without discoloration and the colour remains as intensive as at the moment of installation. Except for the design, we also took care of the practicality. Due to the water resistance and matte surface, TORE is easy to clean. It will not be damaged in the process of scrubbing or vacuuming.

In addition, our product is environmentally safe. The printing technology is using the VOC Free and solvent-free inks and is eco-friendly. All these factors resulted in an excellent product which we are proud to share with you.



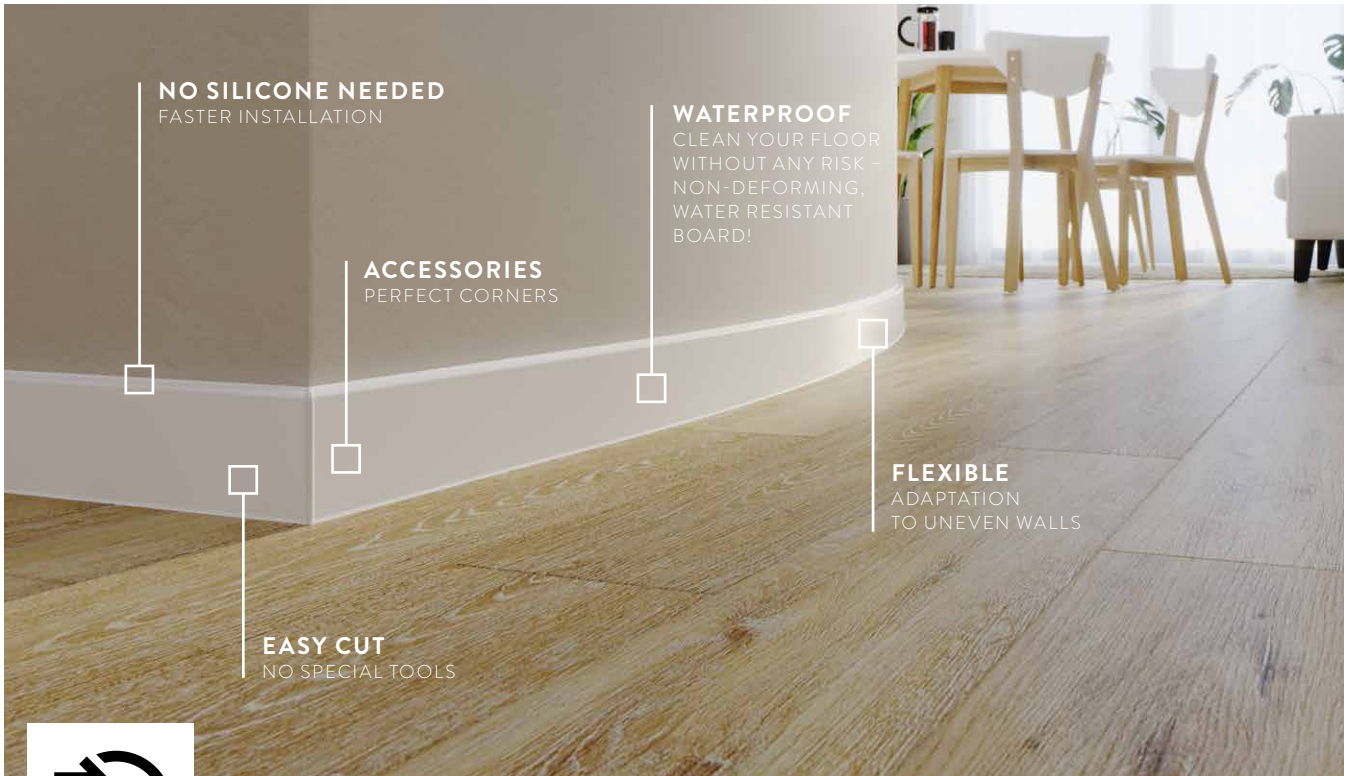

## VIGO

### SOLID CORE SKIRTING BOARDS

IT IS TIME TO END WITH DIFFICULT CHOICES. Thanks to our solutions we've created a skirting board in hybrid technology. Now, you have high quality surface of lacquered MDF skirtings and the flexibility and waterproofness of PVC skirtings.

What else? Easy assembly and dirt resistance. Thanks to the additional flexible and integrated seals, we have waterproof barrier on two sides - from the wall and from the floor.

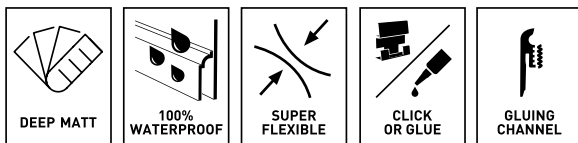

LET'S TAKE A STEP  
INTO THE FUTURE.  
LET'S VIGO

# TORE MONOCOLOR

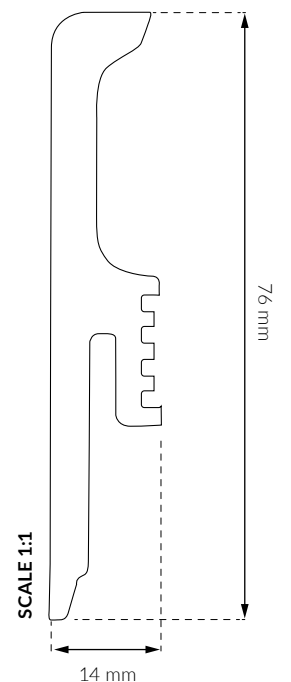

- SOLID CORE SKIRTING BOARD
- DEEP MATT SURFACE
- 100% WATERPROOF SKIRTING BOARDS
- FLEXIBLE CORE, PERFECT FOR ANY KIND OF WALL
- INSTALLATION WITH GLUE OR CLIPS
- GLUING CHANNEL



	SKIRTING	STRONGMAN GLUE	CLIPS AND DOWELS
	220 cm	-	ø 6 mm
	-	1 pc	20 pcs
	22 m	12 pcs	1200 pcs
EAN		5905167788264	5905167826737





**01 | White (RAL 9003)**  
TORE 80 | 5905167845905



**05 | Black (RAL 9011)**  
TORE 80 | 5905167845912



**PROTECTIVE FOIL**  
Protective foil removable  
after renovation



# TORE

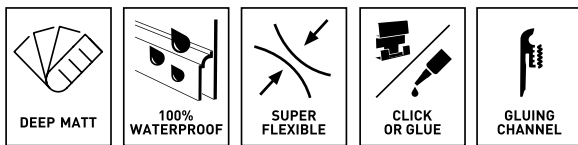

- SOLID CORE SKIRTING BOARD
- HIGH RESOLUTION WOOD DESIGN PRINTING
- DEEP MATT SURFACE
- 100% WATERPROOF SKIRTING BOARDS
- FLEXIBLE CORE, PERFECT FOR ANY KIND OF WALL
- INSTALLATION WITH GLUE OR CLIPS
- GLUING CHANNEL

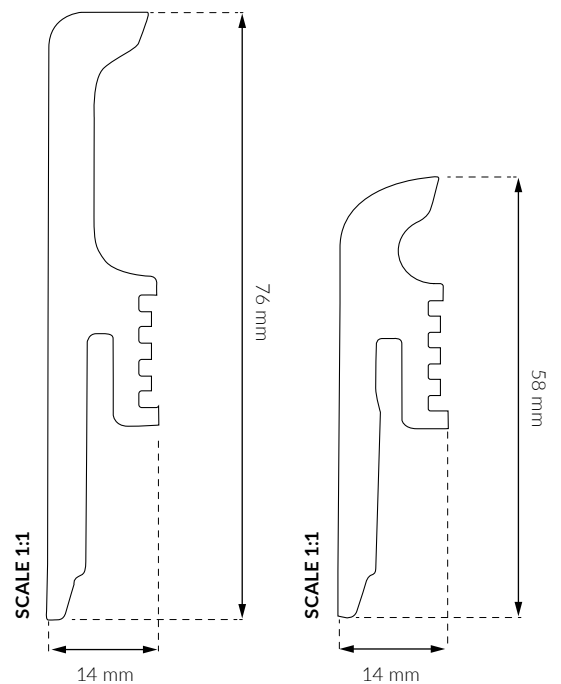

	SKIRTING	STRONGMAN GLUE	CLIPS AND DOWELS
cm /	220 cm	-	ø 6 mm
	-	1 pc	20 pcs
	22 m	12 pcs	1200 pcs
EAN		5905167788264	5905167826737



**101 | Alaskan Oak**

TORE 60 | 5905167835388  
TORE 80 | 5905167835777



**103 | Bergen Oak**

TORE 60 | 5905167835395  
TORE 80 | 5905167835784



**104 | Canadian Oak**

TORE 60 | 5905167835401  
TORE 80 | 5905167835791



**105 | Coney Oak**

TORE 60 | 5905167835418  
TORE 80 | 5905167835807



**117 | Lahti Oak**

TORE 60 | 5905167835531  
TORE 80 | 5905167835920



**112 | Bologna Oak**

TORE 60 | 5905167835487  
TORE 80 | 5905167835876



**124 | Camden Oak**

TORE 60 | 5905167835609  
TORE 80 | 5905167835999



**116 | Argos Oak**

TORE 60 | 5905167835524  
TORE 80 | 5905167835913



**115 | Oregon Oak**

TORE 60 | 5905167835517  
TORE 80 | 5905167835906



**109 | Georgia Oak**

TORE 60 | 5905167835456  
TORE 80 | 5905167835845



**151 | Baker Concrete**

TORE 60 | 5905167835678  
TORE 80 | 5905167836064



**152 | Hamburg Concrete**

TORE 60 | 5905167835685  
TORE 80 | 5905167836071



**101 | Glacier Concrete**

TORE 60 | 5905167835654  
TORE 80 | 5905167836040



**103 | Tokio Concrete**

TORE 60 | 5905167835661  
TORE 80 | 5905167836057



**104 | Toronto Concrete**

TORE 60 | 5905167835555  
TORE 80 | 5905167835944



**105 | Miami Concrete**

TORE 60 | 5905167835562  
TORE 80 | 5905167835951



**101 | Brooklyn Concrete**

TORE 60 | 5905167835579  
TORE 80 | 5905167835968



**103 | Broadway Concrete**

TORE 60 | 5905167835586  
TORE 80 | 5905167835975



**104 | Manhattan Concrete**

TORE 60 | 5905167835593  
TORE 80 | 5905167835982



**105 | Soho Concrete**

TORE 60 | 5905167835548  
TORE 80 | 5905167835937



**113 | Panama Oak**

TORE 60 | 5905167835494  
TORE 80 | 5905167835883



**108 | Dakota Oak**

TORE 60 | 5905167835449  
TORE 80 | 5905167835838



**158 | Harlow Oak**

TORE 60 | 5905167835746  
TORE 80 | 5905167836132



**106 | Portland Oak**

TORE 60 | 5905167836941  
TORE 80 | 5905167835814



**107 | Pasadena Oak**

TORE 60 | 5905167836934  
TORE 80 | 5905167835821



**169 | Weisshorn Oak**

TORE 60 | 5905167843178  
TORE 80 | 5905167843215



**157 | Ridgefield Oak**

TORE 60 | 5905167835739  
TORE 80 | 5905167836125



**167 | Preston Oak**

TORE 60 | 5905167839430  
TORE 80 | 5905167839447



**146 | Wellington Oak**

TORE 60 | 5905167835616  
TORE 80 | 5905167836002



**114 | Williamsburg Oak**

TORE 60 | 5905167835500  
TORE 80 | 5905167835890



**159 | Wembley Oak**

TORE 60 | 5905167835753  
TORE 80 | 5905167836149



**156 | Leonard Oak**

TORE 60 | 5905167835722  
TORE 80 | 5905167836118



**155 | Mayne Oak**

TORE 60 | 5905167835715  
TORE 80 | 5905167836101



**146 | Belford Oak**

TORE 60 | 5905167835623  
TORE 80 | 5905167836019



**148 | Gaillarde Oak**

TORE 60 | 5905167843161  
TORE 80 | 5905167843208

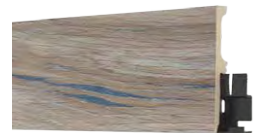

**170 | Patendorf Oak**

TORE 60 | 5905167843185  
TORE 80 | 5905167843222



**110 | Yakima Oak**

TORE 60 | 5905167835463  
TORE 80 | 5905167835852



**111 | Nevada Walnut**

TORE 60 | 5905167835470  
TORE 80 | 5905167835869



**153 | Yankee Oak**

TORE 60 | 5905167835692  
TORE 80 | 5905167836088



**171 | Stamberger Oak**

TORE 60 | 5905167843192  
TORE 80 | 5905167843239



**154 | Sierra Oak**

TORE 60 | 5905167835708  
TORE 80 | 5905167836095



**147 | Georgetown Oak**

TORE 60 | 5905167835630  
TORE 80 | 5905167836026



**148 | Grants Oak**

TORE 60 | 5905167835647  
TORE 80 | 5905167836033



**176 | Hayworth Oak**

TORE 60 | 5905167845806  
TORE 80 | 5905167845851



**177 | Medici Oak**

TORE 60 | 5905167845813  
TORE 80 | 5905167845868



**181 | Stamford Oak**

TORE 60 | 5905167845820  
TORE 80 | 5905167845875



**187 | Dearwood Oak**

TORE 60 | 5905167845837  
TORE 80 | 5905167845882



**184 | Windsor Oak**

TORE 60 | 5905167845844  
TORE 80 | 5905167845899





# VIGO 80



- HYBRID TECHNOLOGY
- NO NEED FOR SILICONE
- FLEXIBLE AND DURABLE
- PROTECTIVE LAYER
- WATERPROOF AND DIRT RESISTANCE
- QUICK INSTALLATION
- GLUING CHANNEL

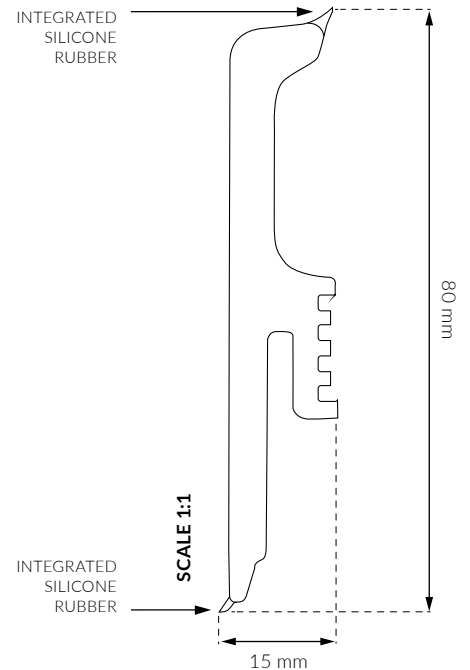

SKIRTING



STRONGMAN GLUE



CLIPS AND DOWELS



CLIP



DOWEL



ACCESSORIES



ACCESSORIES



EAN

220 cm

-

ø 6 mm

-

1 pc

20 pcs

2 pcs

2 pcs

2 pcs

1L + 1R

22 m

12 pcs

1200 pcs

30 pcs

30 pcs

30 pcs

30 pcs

5905167788264

5905167826737



**01 | White** | RAL 9003  
SKIRTING | 5905167826478  
CS PROFILE | 40



**03 | Dark Gray** | RAL 7042  
SKIRTING | 5905167826492  
CS PROFILE | A1



**PROTECTIVE FOIL**  
Protective foil removable  
after renovation

## PERFECT CORNERS



## CUTTING METHODS OF CORNERS



**MANUAL CUTTING**  
The possibility of cutting  
corners with a hand saw



**MITRE SAW**  
The possibility of cutting  
corners with a mitre saw





# VIGO 60

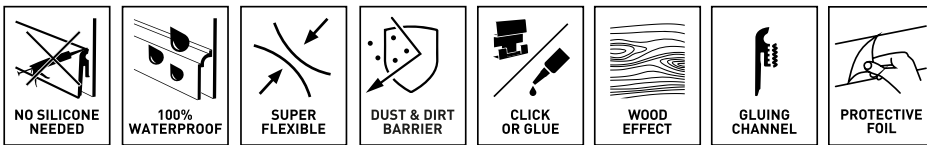

- HYBRID TECHNOLOGY
- NO NEED FOR SILICONE
- FLEXIBLE AND DURABLE
- PROTECTIVE LAYER
- WATERPROOF AND DIRT RESISTANCE
- QUICK INSTALLATION
- GLUING CHANNEL

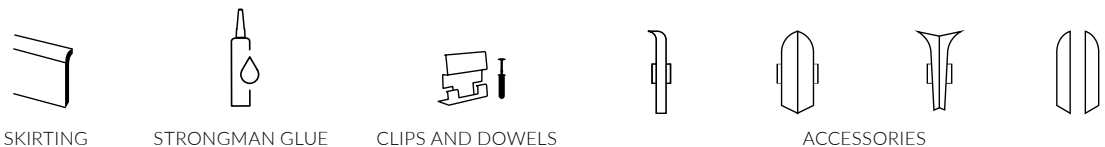
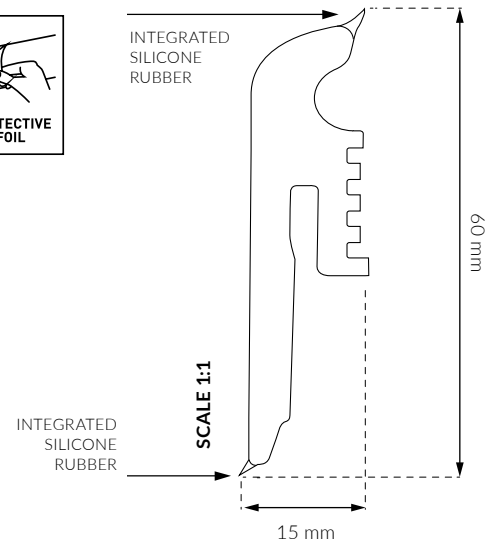

	220 cm	-	ø 6 mm				
	-	1 pc	20 pcs	2 pcs	2 pcs	2 pcs	1L + 1R
	22 m	12 pcs	1200 pcs	30 pcs	30 pcs	30 pcs	30 pcs

EAN 5905167788264 5905167826737





**01 | White** | RAL 9003  
SKIRTING | 5905167825679  
CS PROFILE | 40



**02 | Gray** | RAL 7035  
SKIRTING | 5905167825686  
CS PROFILE | A1



**03 | Dark Gray** | RAL 7042  
SKIRTING | 5905167825693  
CS PROFILE | 45



**04 | Anthracite** | RAL 7024  
SKIRTING | 5905167825709  
CS PROFILE | 52



**102 | Scandinavian Oak**  
SKIRTING | 5905167825716  
CS PROFILE | 19



**112 | Bradford Oak**  
SKIRTING | 5905167825723  
CS PROFILE | 27



**107 | Vermont Oak**  
SKIRTING | 5905167825747  
CS PROFILE | 03



**158 | Monument Oak**  
SKIRTING | 5905167825730  
CS PROFILE | 158



**159 | Newport Oak**  
SKIRTING | 5905167825754  
CS PROFILE | 159



**160 | Calvia Oak**  
SKIRTING | 5905167825761  
CS PROFILE | 159



**161 | Goldberg Oak**  
SKIRTING | 5905167825778  
CS PROFILE | 159



**163 | Rosspot Oak**  
SKIRTING | 5905167825792  
CS PROFILE | 09



**154 | Sierra Oak**  
SKIRTING | 5905167825822  
CS PROFILE | 47



**110 | Jersey Oak**  
SKIRTING | 5905167825808  
CS PROFILE | 07



**147 | Georgetown Oak**  
SKIRTING | 5905167825815



**162 | Cornwall Oak**  
SKIRTING | 5905167825785  
CS PROFILE | 162



**25 | Girona Chestnut**  
SKIRTING | 5905167844960  
CS PROFILE | 25



**44 | Bolton Oak**  
SKIRTING | 5905167844977  
CS PROFILE | 42, 19



**16 | Caucasian Oak**  
SKIRTING | 5905167844984  
CS PROFILE | 23



**22 | Northern Ash**  
SKIRTING | 5905167844991  
CS PROFILE | 02



**173 | Rodenbach Oak**  
SKIRTING | 5905167845004  
CS PROFILE | 158



**09 | Manorial Oak**  
SKIRTING | 5905167845011  
CS PROFILE | 47



**12 | Dark Oak**  
SKIRTING | 5905167845028  
CS PROFILE | 12



**174 | Porto Oak**  
SKIRTING | 5905167845035  
CS PROFILE | 11

## PERFECT CORNERS



## CUTTING METHODS OF CORNERS



### MANUAL CUTTING

The possibility of cutting corners with a hand saw



### MITRE SAW

The possibility of cutting corners with a mitre saw

SKIRTING BOARDS

# NON-PVC WATERPROOF COLLECTIONS

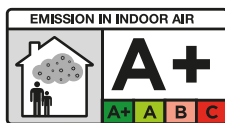

Information sur le niveau d'émission de substances volatiles dans l'air intérieur, présentant un risque de toxicité par inhalation, sur une échelle de classe allant de A+ (très faibles émissions) à C (fortes émissions)

 0%  
PHTHALATES





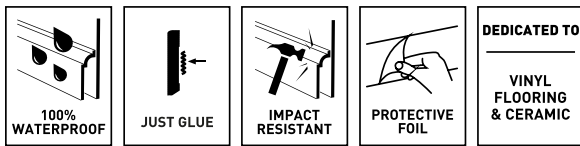

STIQ  
AVIA  
VEGA  
INTEGRA

NON-PVC  
WATERPROOF



- WATERPROOF
- JUST GLUE
- IMPACT RESISTANT
- HOMOGENEOUS MATERIAL (100% PVC FREE)
- NO PAINTS AND LACQUERS
- VOC FREE
- PERFECT FOR RECYCLING
- DEDICATED TO VINYL FLOORING & CERAMIC

	SKIRTING	STRONGMAN GLUE	ACRYLIC
 cm / 	220 cm	-	-
	-	1 pc	1 pc
	44 m	12 pcs	12 pcs
EAN		5905167788264	5907584890193



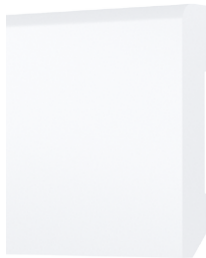
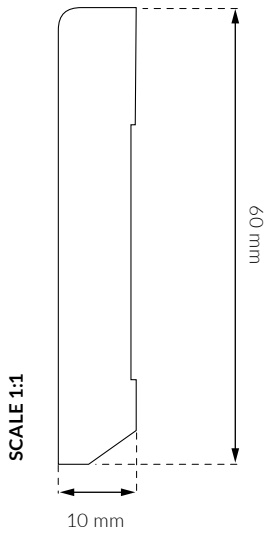

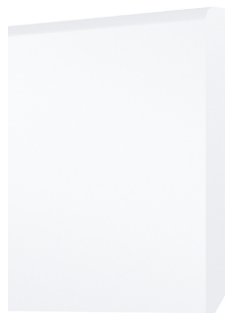
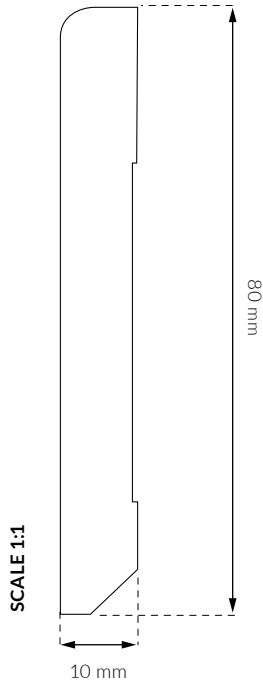

**White**  
 S611 | 5905167839997  
 | 44 m

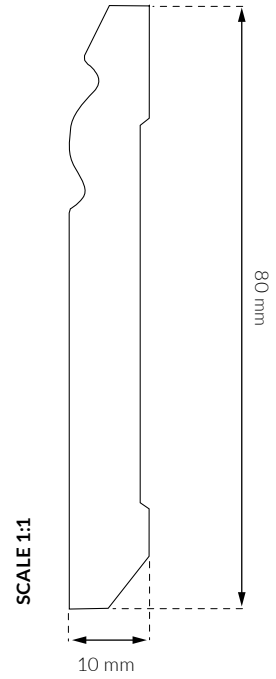

**White**  
 S810 | 5905167839850  
 | 44 m



**White**  
 S820 | 5905167839867  
 | 44 m





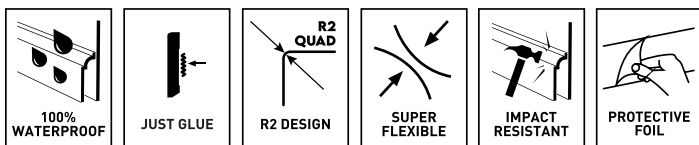

**PROTECTIVE FOIL**  
 Protective foil removable  
 after renovation

# STIQ XL

**NEW**



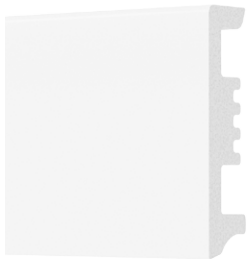
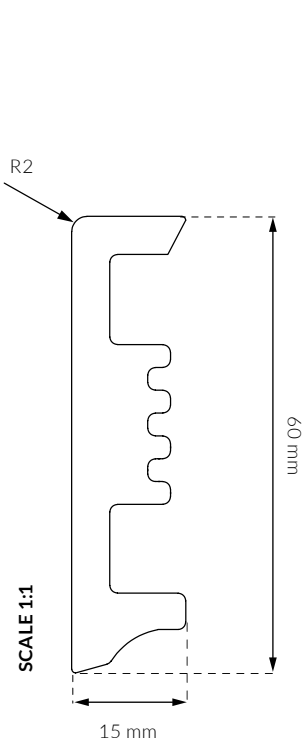

- WATERPROOF
- R2 DESIGN
- JUST GLUE
- SUPER FLEXIBLE
- IMPACT RESISTANT
- HOMOGENEOUS MATERIAL (100% PVC FREE)
- NO PAINTS AND LACQUERS
- VOC FREE
- PERFECT FOR RECYCLING

	SKIRTING	STRONGMAN GLUE	ACRYLIC
 cm / 	220 cm	-	-
	-	1 pc	1 pc
	44 m	12 pcs	12 pcs
EAN		5905167788264	5907584890193

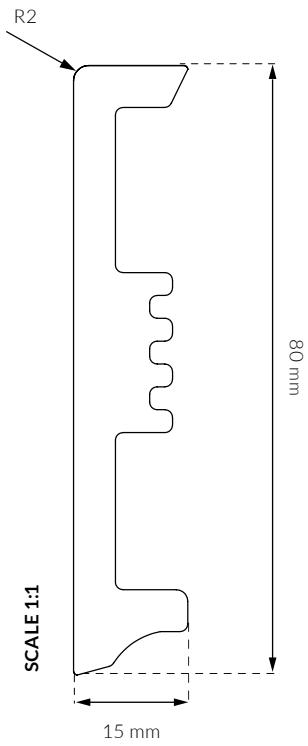

**White**  
 STX610 | 5905167839874  
 | 44 m



**White**  
 STX810 | 5905167839881  
 | 44 m

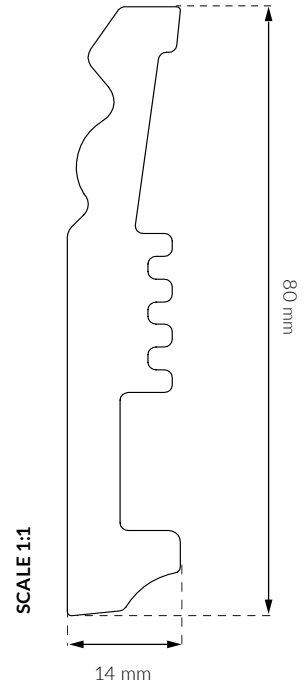

**White**  
 STX820 | 5905167839898  
 | 44 m



**PROTECTIVE FOIL**  
 Protective foil removable  
 after renovation

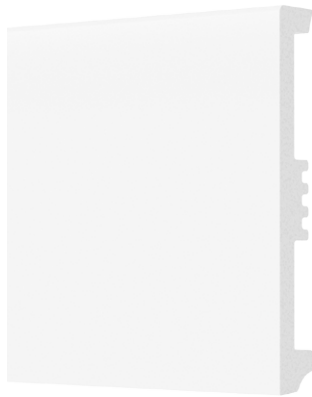
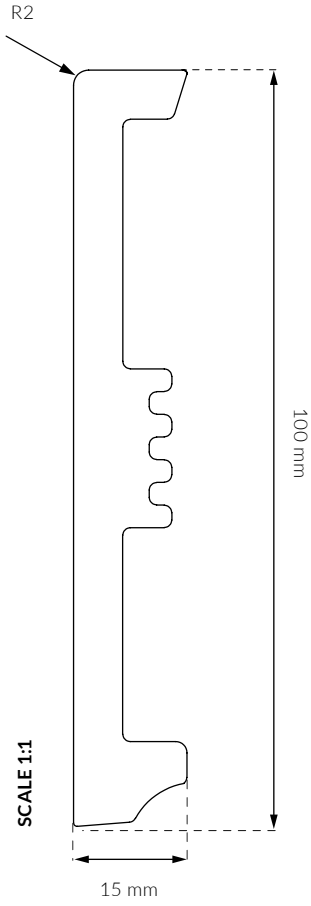

**White**  
 STX110 | 5905167839904  
 44 m

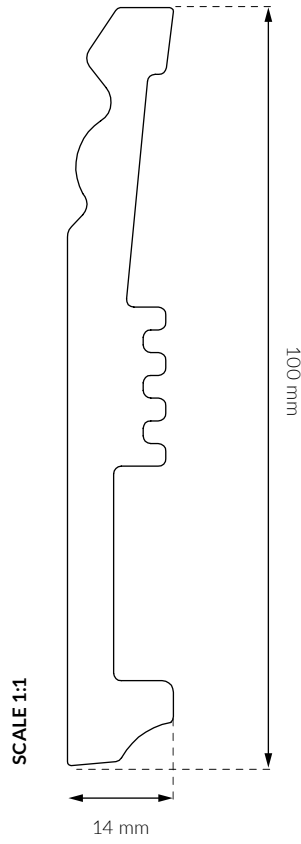

**White**  
 STX120 | 5905167839911  
 44 m



**PROTECTIVE FOIL**  
 Protective foil  
 removable  
 after renovation







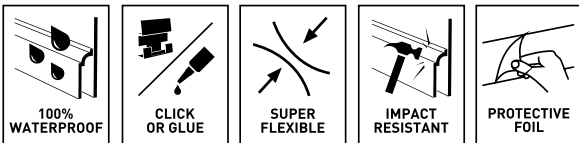

**100%  
PVC  
FREE**



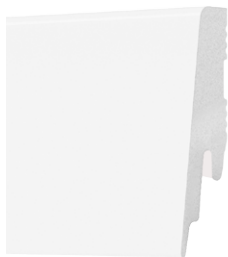
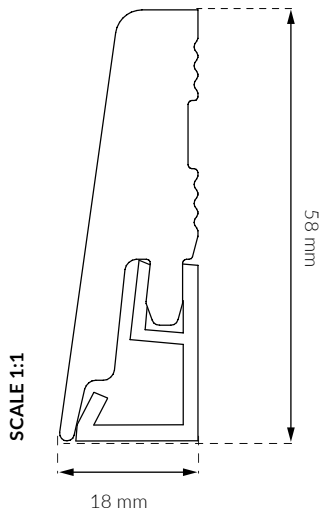

- WATERPROOF
- PERFECT FOR RENOVATION
- JUST GLUE
- SUPER FLEXIBLE
- IMPACT RESISTANT
- HOMOGENEOUS MATERIAL (100% PVC FREE)
- NO PAINTS AND LACQUERS
- VOC FREE
- PERFECT FOR RECYCLING

	SKIRTING	STRONGMAN GLUE	ACRYLIC	ACCESSORIES			
	220 cm	-	-	-	-	-	-
	-	1 pc	1 pc	2 pcs / 15 pack	2 pcs / 15 pack	2 pcs / 15 pack	1L + 1R 15 L 15 R
	44 m	12 pcs	12 pcs	-	-	-	-
EAN		5905167788264	5907584890193				

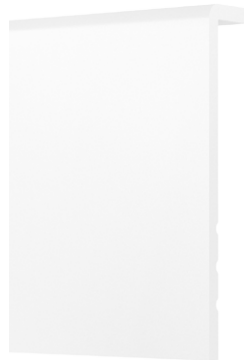
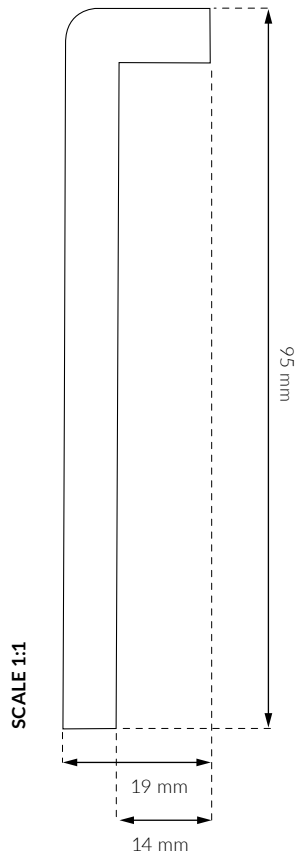

**White**  
 STP580 | 5905167839928  
 | 44 m



**White**  
 STP950 | 5905167839980  
 | 44 m



**PROTECTIVE FOIL**  
 Protective foil  
 removable  
 after renovation



ACCESSORIES



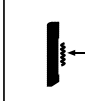
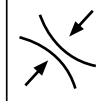
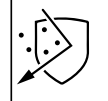

 <b>100% WATERPROOF</b>	 <b>JUST GLUE</b>	 <b>SUPER FLEXIBLE</b>	 <b>DUST &amp; DIRT BARRIER</b>	<b>PERFECT FOR ECOMMERCE</b>	<b>DEDICATED TO VINYL FLOORING &amp; LAMINATE</b>
---	---	--	---	------------------------------	---

- PERFECT FOR ECOMMERCE
- WATERPROOF
- JUST GLUE
- DUST AND DIRT BARRIER
- SUPER FLEXIBLE
- HOMOGENEOUS MATERIAL (100% PVC FREE)
- NO PAINTS AND LACQUERS
- VOC FREE
- PERFECT FOR RECYCLING

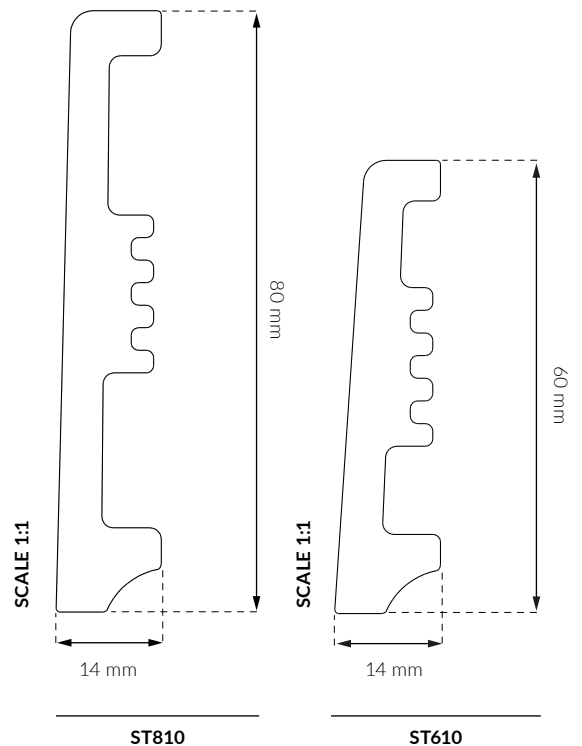





SKIRTING



STRONGMAN GLUE



ACRYLIC

 cm		200cm	-	-
		-	1 pc	1 pc
		20 m	12 pcs	12 pcs
EAN		5905167788264	5907584890193	





**01 | White**

ST610

5905167838877



**01 | White**

ST810







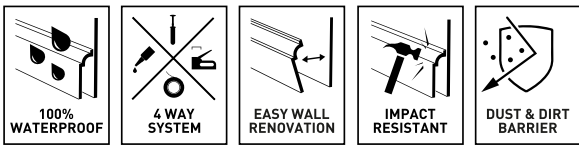

5905167838891





# VEGA



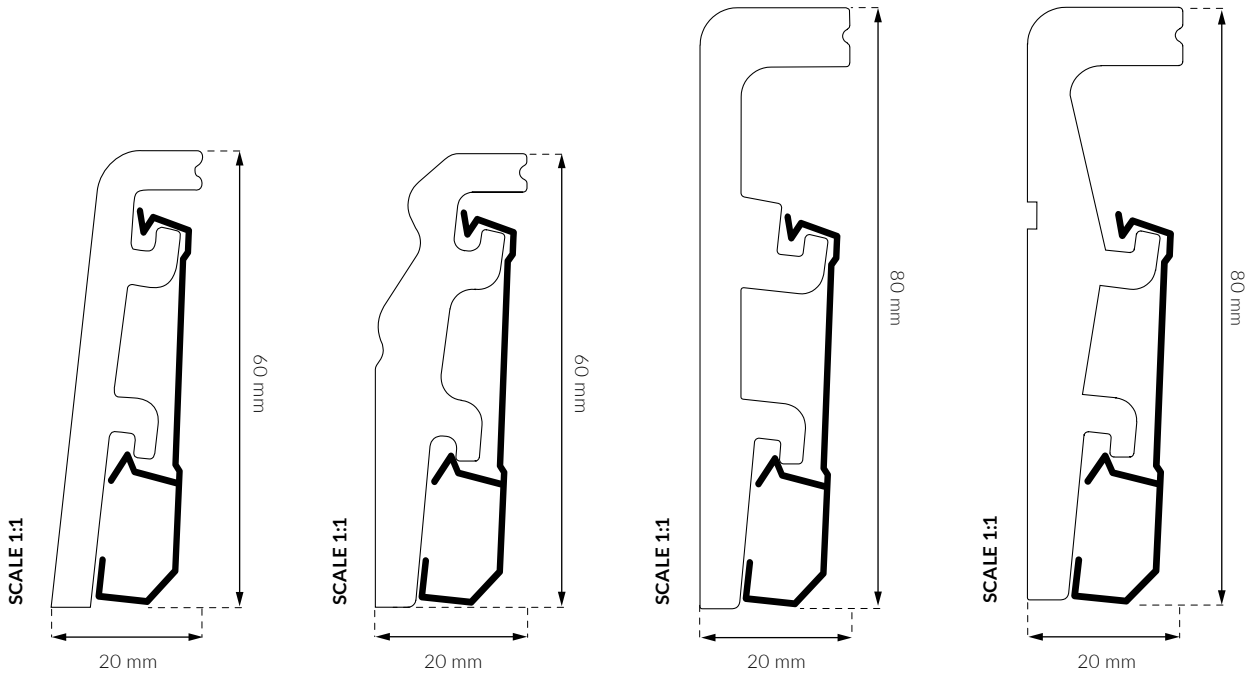

- WATERPROOF
- 4 WAY SYSTEM
- EASY WALL RENOVATION
- IMPACT RESISTANT
- DUST AND DIRT BARRIER
- 100% PVC FREE

	 SKIRTING	 BLOCKS	 STRONGMAN GLUE	 TAPE	 ACRYLIC
	240 cm	2,3x2,3x15,2 cm	-	-	-
	-	4 pcs = 1 set	1 pc	1 pc	1 pc
	24 m / 28,8 m	10 sets	12 pcs	24 pcs	12 pcs
EAN		5905167746844	5905167788264	5905167731444	5907584890193

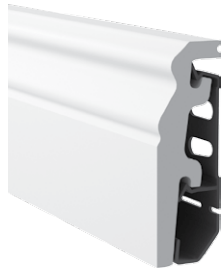

**White**  
 P0610 | 5905167747926  
 | 24 m



**White**  
 P0620 | 5905167755662  
 | 21,8 m



**White**  
 P0810 | 5905167734551  
 | 24 m



**White**  
 P0811 | 5905167734568  
 | 24 m

ACCESSORIES / UNIVERSAL BLOCK

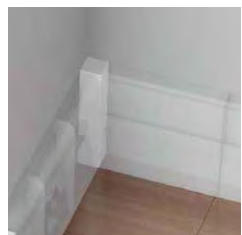
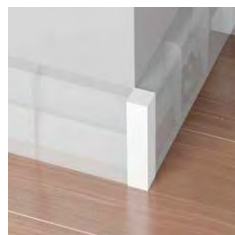
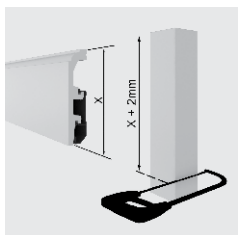
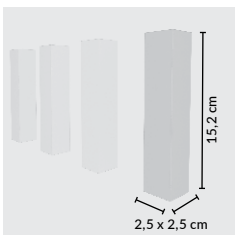



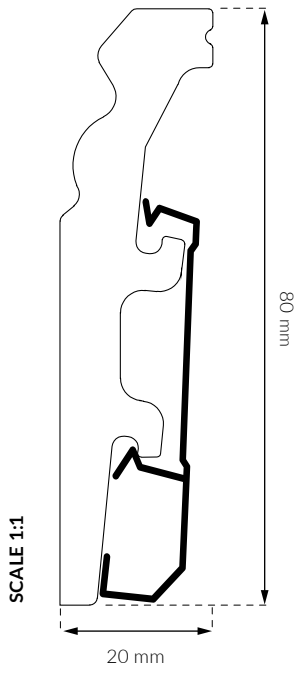

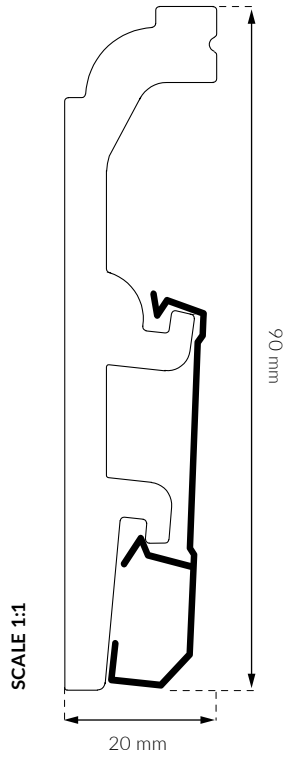

**White**

P0830 | 5905167755679  
 24 m



**White**

P0910 | 5905167734605  
 24 m

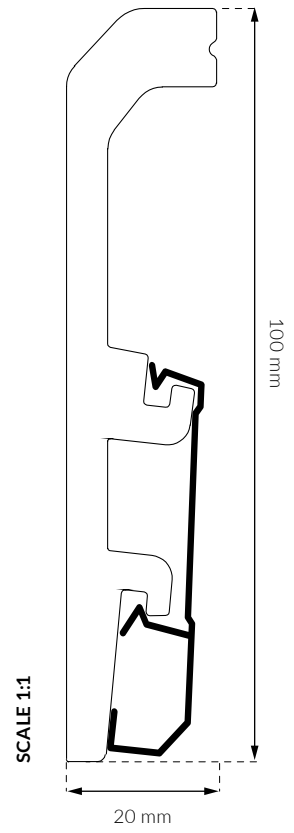

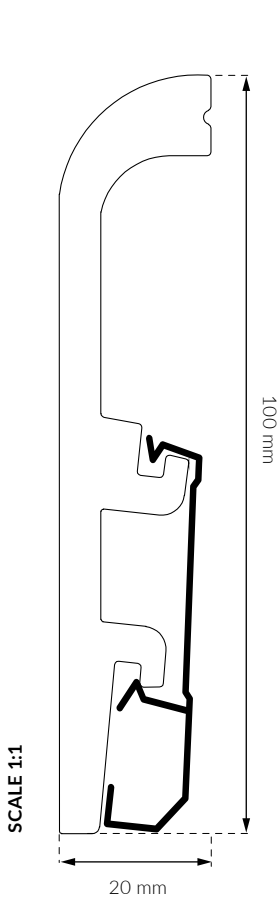

**White**

P1010 | 5905167734629  
 24 m

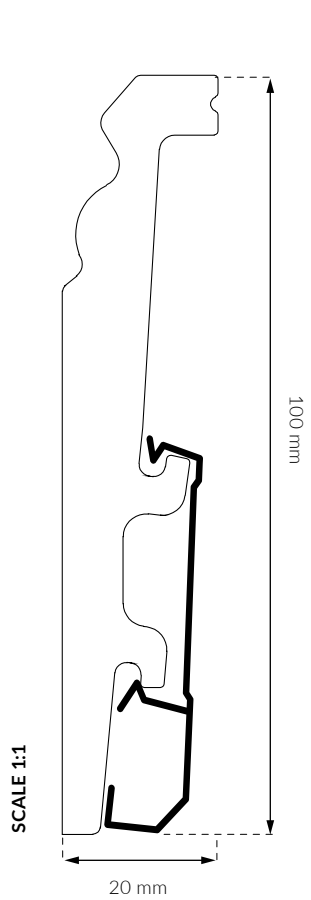

**White**  
 P1020 | 5905167734643  
 24 m



**White**  
 P0910 | 5905167734605  
 24 m

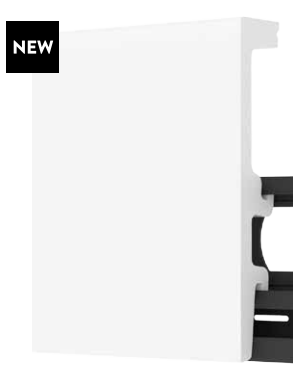
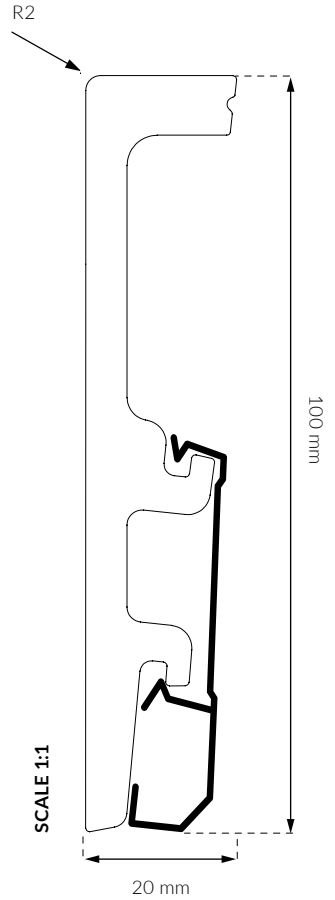

**White**  
 P1040 | 5905167839843  
 24 m

# INTEGRA

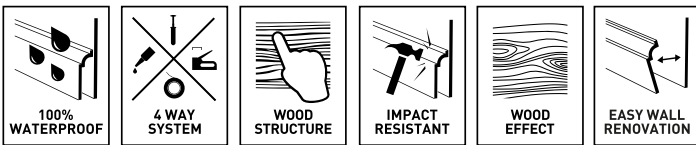

- WATERPROOF
- 4 WAY SYSTEM
- IMPACT RESISTANT
- WOOD STRUCTURE
- IMPACT RESISTANT
- WOOD EFFECT
- EASY WALL RENOVATION
- HOMOGENEOUS MATERIAL (100% PVC FREE)
- NO PAINTS AND LACQUERS
- VOC FREE
- PERFECT FOR RECYCLING

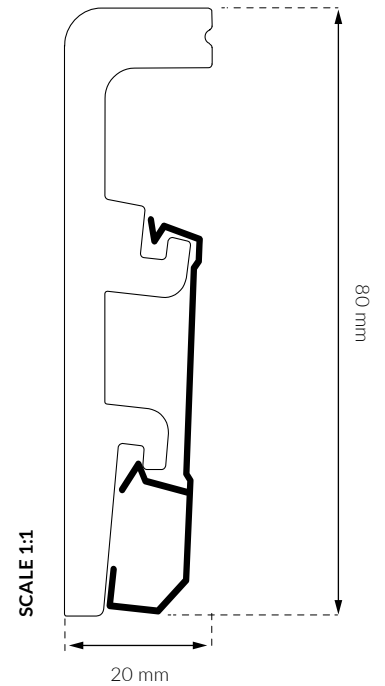

SKIRTING



STRONGMAN GLUE



TAPE



240 cm

-

-



-

1 pc

1 pcs



24 m

12 pcs

24 pcs

EAN

5905167788264

5905167731444



**01 | White**  
SKIRTING | 5905167734353



**02 | Aluminium**  
SKIRTING | 5905167734360



**3 | Snow Ash**  
SKIRTING | 5905167734377



**12 | Roma Oak**  
SKIRTING | 5905167734469



**7 | Alabama Oak**  
SKIRTING | 5905167734414



**14 | Oregon Oak**  
SKIRTING | 5905167734483



**5 | City Oak**  
SKIRTING | 5905167734391



**4 | Northern Ash**  
SKIRTING | 5905167734384



**6 | Alaska Ash**  
SKIRTING | 5905167734407



**11 | Persian Oak**  
SKIRTING | 5905167734452



**46 | Davos Oak**  
SKIRTING | 5905167838228



**44 | Manorial Oak**  
SKIRTING | 5905167838204



**9 | Classic Oak**  
SKIRTING | 5905167734438



**8 | Nevada Oak**  
SKIRTING | 5905167734421



**10 | Calvados Oak**  
SKIRTING | 5905167734445



**19 | Natural Oak**  
SKIRTING | 5905167734537



**18 | Loft Oak**  
SKIRTING | 5905167734520



**17 | Dark Walnut**  
SKIRTING | 5905167734513



**45 | Wenge Africa**  
SKIRTING | 5905167838211



**20 | Borneo Oak**  
SKIRTING | 5905167734544



SKIRTING BOARDS

**MODERN PVC**  
COLLECTIONS





INDO  
LARS  
MACK

MODERN  
PVC



**WOOD STRUCTURE**

**4 WAY SYSTEM**

**WOOD EFFECT**

**FLEXIBLE**

**EASY WALL RENOVATION**

**EMISSION IN INDOOR AIR**  
**A+**  
A+ A B C

Information sur le niveau d'émission de substances volatiles dans les intérieurs, présentant un risque de santé par inhalation, voir une échelle de classe allant de A+ (très faibles émissions) à C (fortes émissions)

- WOOD STRUCTURE
- 4 WAY SYSTEM
- WOOD EFFECT
- FLEXIBLE
- EASY WALL RENOVATION
- ECO FRIENDLY

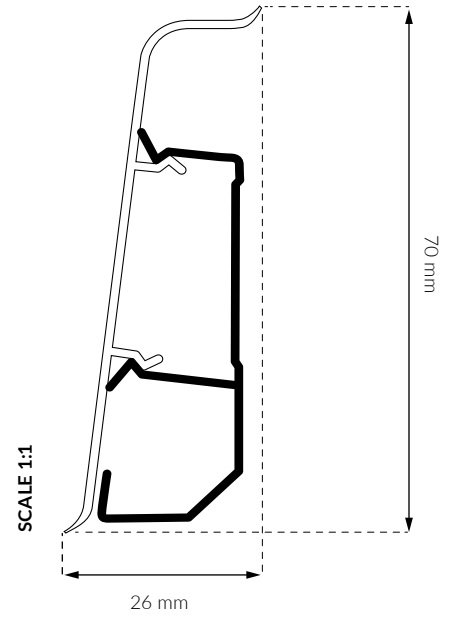

	SKIRTING	STRONGMAN GLUE	TAPE	MULTIBOX	ACCESSORIES			
	250 cm	-	-	-	-	-	-	-
	-	1 pc	1 pc	1 pc	2 pcs / 20 pack	2 pcs / 20 pack	2 pcs / 20 pack	1L + 1R 20 L 20 R
	25 m	12 pcs	24 pcs	10 pcs	30 pcs / 1440 pack	30 pcs / 360 pack	30 pcs / 360 pack	30 pcs / 720 pack 30 pcs / 720 pack
EAN		5905167788264	5905167731444	5906735698503				



**01 | White**

SKIRTING | 5905167725719  
CS PROFILE | 40



**40 | White Mat**

SKIRTING | 5905167781685  
CS PROFILE | 40



**134 | Cambridge**

SKIRTING | 5905167806036



**133 | Oxford**

SKIRTING | 5905167806029  
CS PROFILE | 45



**41 | Alu Light**

SKIRTING | 5905167781340  
CS PROFILE | A1



**17 | Aluminium**

SKIRTING | 5905167729281



**25 | Girona Chestnut**

SKIRTING | 5905167781326  
CS PROFILE | 19



**19 | Ontario Oak**

SKIRTING | 5905167755006



**44 | Bolton Oak**

SKIRTING | 5905167799000  
CS PROFILE | 02



**137 | Selma Oak**

SKIRTING | 5905167816981  
CS PROFILE | 50



**135 | Platinum Oak**

SKIRTING | 5905167806067



**112 | Bradford Oak**

SKIRTING | 5905167838235



**16 | Caucasian Oak**

SKIRTING | 5905167725863



**23 | Modena Oak**

SKIRTING | 5905167755044  
CS PROFILE | 23



**131 | Philadelphia Oak**

SKIRTING | 5905167806043  
CS PROFILE | 46



**02 | Northern Ash**

SKIRTING | 5905167725726  
CS PROFILE | 26



**42 | Sand Oak**

SKIRTING | 5905167781692  
CS PROFILE | 03



**20 | Burgos Oak**

SKIRTING | 5905167755013  
CS PROFILE | 20



**03 | Loft Oak**

SKIRTING | 5905167725733  
CS PROFILE | 03



**138 | Pasadena Oak**

SKIRTING | 5905167816998  
CS PROFILE | 44



**158 | Monument Oak**

SKIRTING | 5905167838259  
CS PROFILE | 158



**04 | Lingburg Oak**

SKIRTING | 5905167725740  
CS PROFILE | 04





**153 | Yankee Oak**  
SKIRTING | 5905167825075



**05 | Windston Oak**  
SKIRTING | 5905167725757  
CS PROFILE | 31



**154 | Sierra Oak**  
SKIRTING | 5905167825082  
CS PROFILE | 07



**09 | Manorial Oak**  
SKIRTING | 5905167725795  
CS PROFILE | 65



**110 | Jersey Oak**  
SKIRTING | 5905167838242



**10 | Bourbon Oak**  
SKIRTING | 5905167725801  
CS PROFILE | 09



**139 | Satin Oak**  
SKIRTING | 5905167817001



**43 | Victoria Oak**  
SKIRTING | 5905167781333



**12 | Dark Oak**  
SKIRTING | 5905167725825  
CS PROFILE | 12



**11 | Holm Oak**  
SKIRTING | 5905167725818  
CS PROFILE | 11



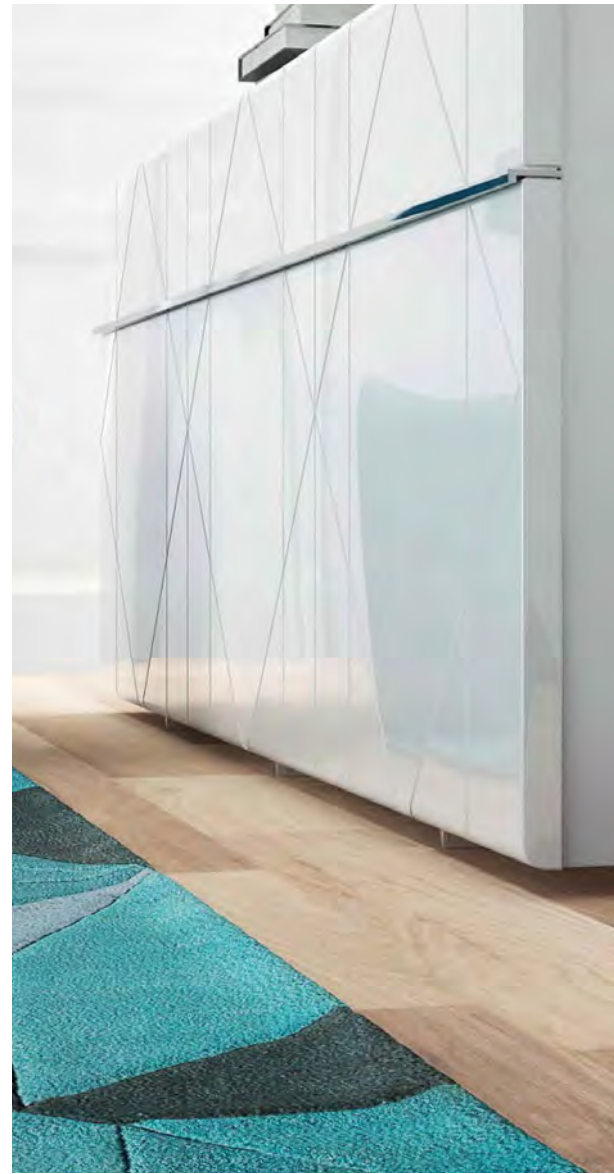

**140 | Tasmanian Oak**  
SKIRTING | 5905167817018  
CS PROFILE | 49





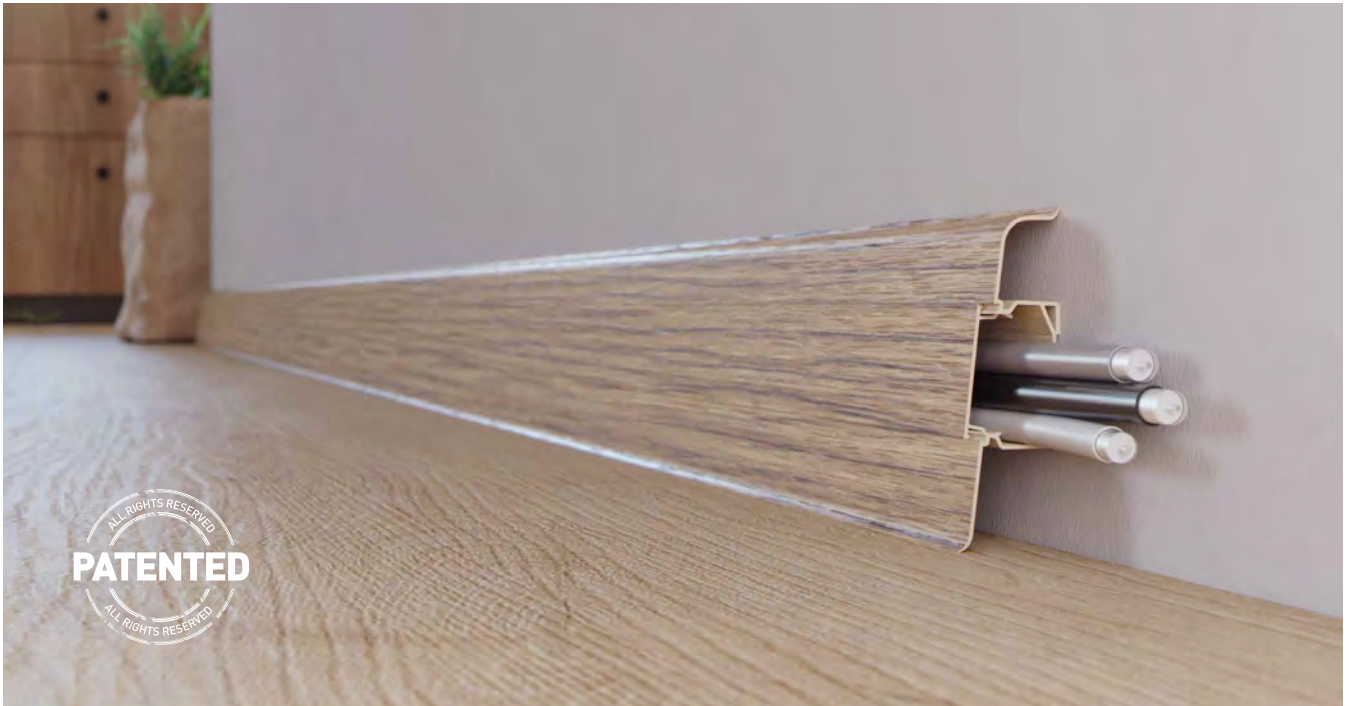

# LARS



  
**WOOD STRUCTURE**



  
**EASY INSTALLATION**

  
**FLEXIBLE**

**MODERN DESIGN**

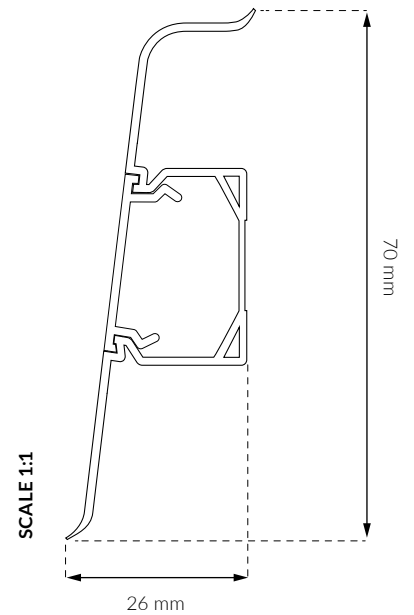
- WOOD STRUCTURE
- EASY INSTALLATION
- FLEXIBLE
- MODERN DESIGN
- ECO FRIENDLY

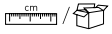

	SKIRTING	STRONGMAN GLUE	TAPE	MULTIBOX	ACCESSORIES			
	250 cm	-	-	-	-	-	-	-
	-	1 pc	1 pc	1 pc	2 pcs / 20 pack	2 pcs / 20 pack	2 pcs / 20 pack	1L + 1R 20 L    20 R
	50 m	12 pcs	24 pcs	10 pcs	30 pcs / 1440 pack	30 pcs / 360 pack	30 pcs / 360 pack	30 pcs / 720 pack    30 pcs / 720 pack
EAN		5905167788264	5905167731444	5906735698503				



**40 | White Mat**

SKIRTING | 5905167783504  
CS PROFILE | 40



**41 | Alu Light**

SKIRTING | 5905167817391



**25 | Snow Ash**

SKIRTING | 5905167783474  
CS PROFILE | 29



**02 | Winterwood Ash**

SKIRTING | 5905167783399  
CS PROFILE | 27



**44 | Platinum Oak**

SKIRTING | 5905167783535



**50 | Scandinavian Oak**

SKIRTING | 5905167783580  
CS PROFILE | 48



**137 | Selma Oak**

SKIRTING | 5905167817384  
CS PROFILE | 50



**16 | Holm Oak**

SKIRTING | 5905167783429



**42 | Arena Oak**

SKIRTING | 5905167783511  
CS PROFILE | 03



**03 | Norwegian Oak**

SKIRTING | 5905167783412  
CS PROFILE | 03



**04 | Alpine Oak**

SKIRTING | 5905167783443  
CS PROFILE | 04



**45 | Swedish Oak**

SKIRTING | 905167783528



**46 | Golden Oak**

SKIRTING | 5905167783559  
CS PROFILE | 09



**09 | Noble Oak**

SKIRTING | 5905167783436  
CS PROFILE | 29



**47 | Tatra Oak**

SKIRTING | 5905167783542



**32 | Elegant Oak**

SKIRTING | 5905167783498  
CS PROFILE | 39



**12 | Brazilian Walnut**

SKIRTING | 5905167783450  
CS PROFILE | 12



**14 | Wood Wenge**

SKIRTING | 5905167783405

ACCESSORIES







**MODERN DESIGN**

- MODERN DESIGN
- EASY INSTALLATION
- FLEXIBLE
- ECO FRIENDLY

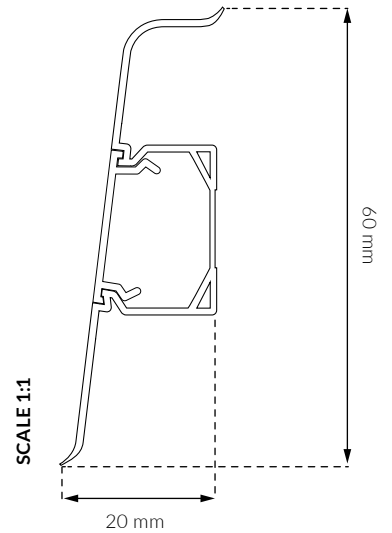

SKIRTING



STRONGMAN GLUE



TAPE



MULTIBOX



ACCESSORIES



EAN

250 cm	-	-	-	-	-	-	-	-
-	1 pc	1 pc	1 pc	2 pcs / 25 pack	2 pcs / 25 pack	2 pcs / 25 pack	1L + 1R 25 L 25 R	
50 m	12 pcs	24 pcs	10 pcs	30 pcs / 1440 pack	30 pcs / 360 pack	30 pcs / 360 pack	30 pcs / 720 pack	30 pcs / 720 pack

5905167788264

5905167731444

5906735698503



**40 I White Mat**

SKIRTING | 5905167803554  
CS PROFILE | 40



**41 I Alu Light**

SKIRTING | 5905167803721



**25 I Girona Chestnut**

SKIRTING | 5905167803578  
CS PROFILE | 42



**107 I Bolton Oak**

SKIRTING | 5905167803585  
CS PROFILE | 19



**131 I Philadelphia Oak**

SKIRTING | 5905167803622  
CS PROFILE | 19



**135 I Platinum Oak**

SKIRTING | 5905167803615



**16 I Caucasian Oak**

SKIRTING | 5905167803639



**02 I North Ash**

SKIRTING | 5905167803592  
CS PROFILE | 26



**42 I Arena Oak**

SKIRTING | 5905167803646



**138 I Pasadena Oak**

SKIRTING | 5905167825280  
CS PROFILE | 44



**03 I Loft Oak**

SKIRTING | 5905167803653  
CS PROFILE | 03



**04 I Lingburg Oak**

SKIRTING | 5905167803660  
CS PROFILE | 04



**153 I Yankee Oak**

SKIRTING | 5905167825297  
CS PROFILE | 153



**136 I Antique Oak**

SKIRTING | 5905167803677



**154 I Sierra Oak**

SKIRTING | 5905167825303  
CS PROFILE | 07



**46 I Golden Oak**

SKIRTING | 5905167825273  
CS PROFILE | 09



**86 I Laplant Oak**

SKIRTING | 5905167803684



**132 I Edmonton Oak**

SKIRTING | 5905167803707

ACCESSORIES



SKIRTING BOARDS

**TRADITIONAL  
PVC**  
COLLECTIONS





LM60  
LM55

TRADITIONAL  
PVC



# LM60

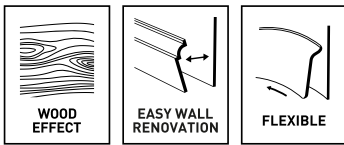

- FLEXIBLE ADAPTATION
- WOOD EFFECT
- ECO FRIENDLY PVC

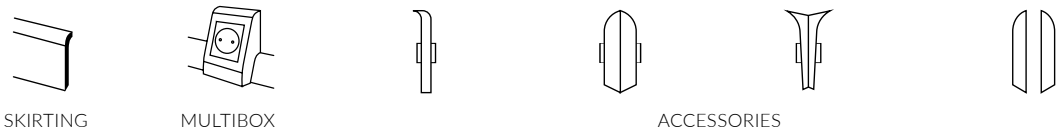
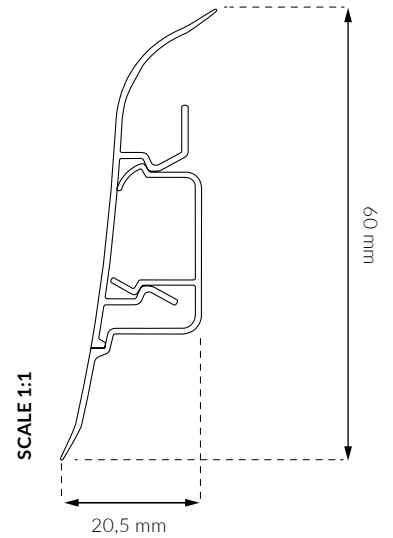

	250 cm	-	-	-	-	-
	-	1 pc	2 pcs / 25 pack	2 pcs / 25 pack	2 pcs / 25 pack	1L + 1R 25 L+25 R 25 L+25 R
	50 m	10 pcs	30 pcs / 1440 pack	30 pcs / 360 pack	30 pcs / 360 pack	30 pcs / 1440 pack 30 pcs / 1440 pack

EAN

5906735698503



**34 | White**  
SKIRTING | 5905167749043



**39 | Aluminium**  
SKIRTING | 5907749020014



**107 | Bolton Oak**  
SKIRTING | 5905167752944



**99 | Kendari Oak**  
SKIRTING | 5905167709542



**44 | Golden Oak**  
SKIRTING | 5907749020083



**58 | Country Oak**  
SKIRTING | 5905167662946



**23 | Ash**  
SKIRTING | 5907749001891



**109 | Sevilla Oak**  
SKIRTING | 5905167753149



**77 | Sand Oak**  
SKIRTING | 5905167662953



**65 | Canyon Oak**  
SKIRTING | 5905167662656



**52 | Ardennes Oak**  
SKIRTING | 5907749020311



**49 | Liverpool Oak**  
SKIRTING | 5907749020144



**70 | White Oak**  
SKIRTING | 5905167663226



**16 | Antique Oak**  
SKIRTING | 5906735694451



**86 | Laplant Oak**  
SKIRTING | 5907749049282



**72 | Bourbon Oak**  
SKIRTING | 5905167663264



**63 | Tosca Oak**  
SKIRTING | 5905167663349



**24 | Highland Oak**  
SKIRTING | 5907749012064



**94 | Victoria Oak**  
SKIRTING | 5905167703175



**74 | Rustic Oak**  
SKIRTING | 5905167663295



**97 | Lagos Oak**  
SKIRTING | 5905167709528

ACCESSORIES



# LM55

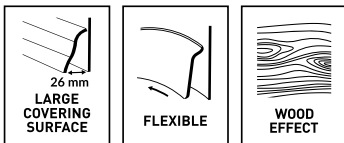

- WOOD EFFECT
- EASY WALL RENOVATION
- FLEXIBLE
- ECO FRIENDLY PVC

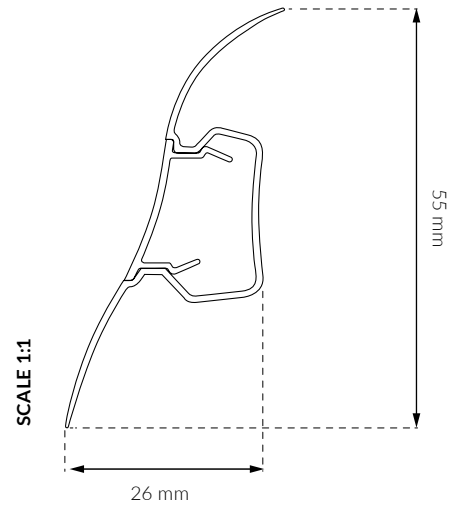

SKIRTING



MULTIBOX



ACCESSORIES

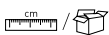

EAN

250 cm	-	-	-	-	-	-
-	1 pc	2 pcs / 25 pack	2 pcs / 25 pack	2 pcs / 25 pack	1L + 1R 25 L+25 R 25 L+25 R	
50 m	10 pcs	30 pcs / 1440 pack	30 pcs / 360 pack	30 pcs / 360 pack	30 pcs / 1440 pack	30 pcs / 1440 pack

5906735698503



**101 | White Matt**  
SKIRTING | 5905167735558



**108 | Aspen Oak**  
SKIRTING | 5905167788349



**107 | Girona Chestnut**  
SKIRTING | 5905167788332



**45 | Grey Acacia**  
SKIRTING | 5907749020236



**104 | Sardinia Oak**  
SKIRTING | 5905167741948



**48 | Golden Oak**  
SKIRTING | 5907749020243



**58 | Country Oak**  
SKIRTING | 5905167662748



**103 | Havana Oak**  
SKIRTING | 5905167741153



**77 | Sand Oak**  
SKIRTING | 5905167734810



**49 | Belfast Oak**  
SKIRTING | 5907749020250



**23 | Ash**  
SKIRTING | 5907749001174



**102 | Almelo Oak**  
SKIRTING | 5905167741146



**65 | Canyon Oak**  
SKIRTING | 5905167662762



**110 | Ginkgo Biloba**  
SKIRTING | 5905167788363



**47 | Liverpool Oak**  
SKIRTING | 5907749014853



**109 | Ageing Oak**  
SKIRTING | 5905167788356



**20 | Savoyen Oak**  
SKIRTING | 5906735647785



**28 | Pecan**  
SKIRTING | 5907749001228



**34 | Alaska Oak**  
SKIRTING | 5907749014716



**16 | Antique Oak**  
SKIRTING | 5906735647747



**85 | North Oak**  
SKIRTING | 5907749049329



**67 | Classic Light Oak**  
SKIRTING | 5905167662885



**86 | Laplant Oak**  
SKIRTING | 5905167670293



**83 | Romantic Oak**  
SKIRTING | 5905167662915



**26 | Dark Oak**  
SKIRTING | 5907749001204



**112 | Jupiter Walnut**  
SKIRTING | 5905167788387



**22 | Wenge Africa**  
SKIRTING | 5907749001167

ACCESSORIES



SKIRTING BOARDS

**TRADITIONAL  
MDF**  
COLLECTIONS

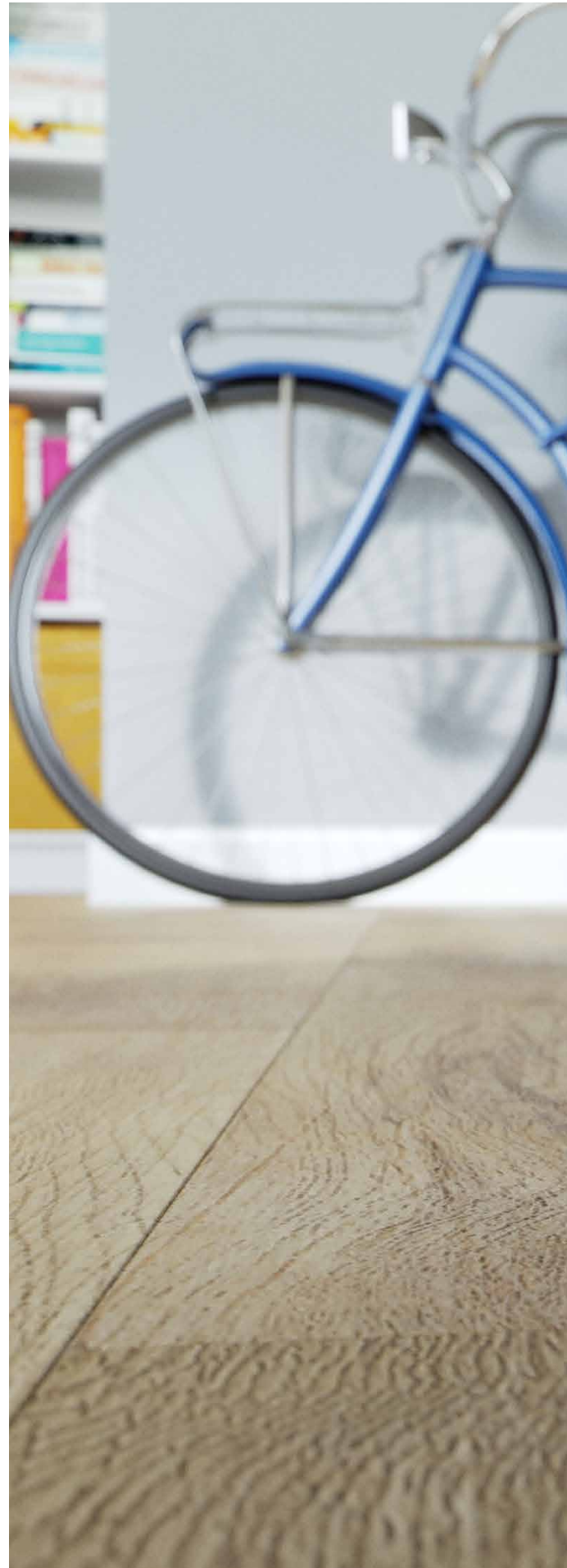











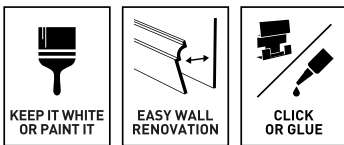

**PAINT IT  
DIAMOND**

TRADITIONAL  
MDF

# PAINT IT



- KEEP IT WHITE OR PAINT IT
- EASY WALL RENOVATION
- CLICK OR GLUE

					
	SKIRTING	BLOCKS	CLIPS AND DOWELS	STRONGMAN GLUE	ACRYLIC
	242 cm	1,8x1,8x11,2 cm	ø 6 mm	-	-
	-	4 pcs = 1 set	25 pcs	1 pc	1 pc
	24,2 m	10 sets	1500 pcs	12 pcs	12 pcs
EAN		5905167736937	5905167674437	5905167788264	5907584890193

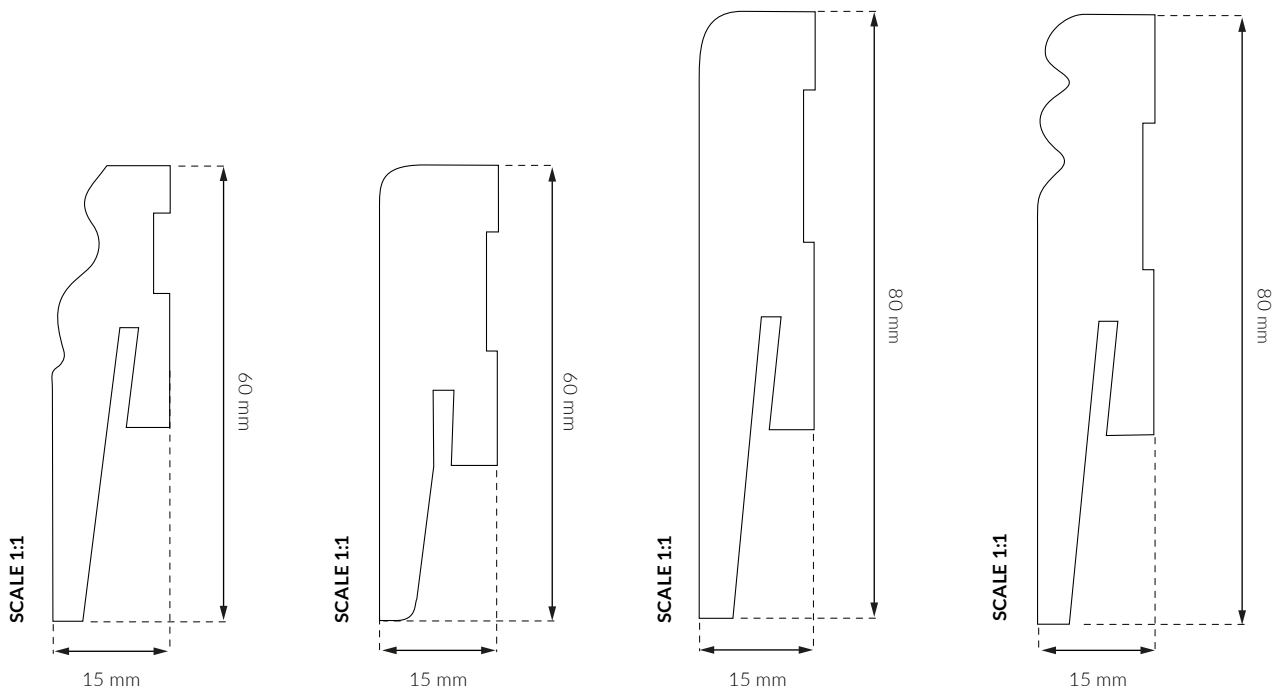

**White**  
MP0601 | 5905167674338  
📦 24,2 m



**White**  
MP0602 | 5905167754986  
📦 24,2 m



**White**  
MP0801 | 5905167674345  
📦 24,2 m



**White**  
MP0802 | 5905167674352  
📦 24,2 m

ACCESSORIES / UNIVERSAL BLOCK



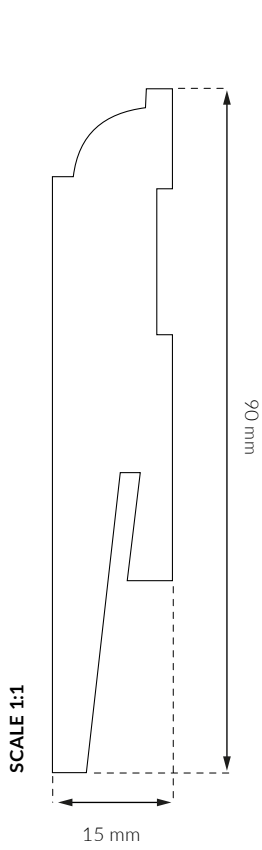

**White**

MP0901 | 5905167674369  
 24,2 m

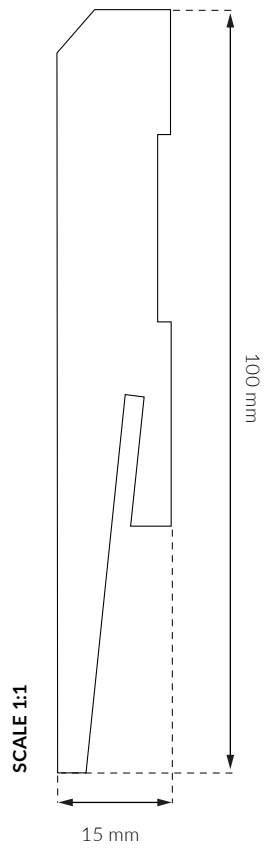

**White**

MP1001 | 5905167674376  
 24,2 m

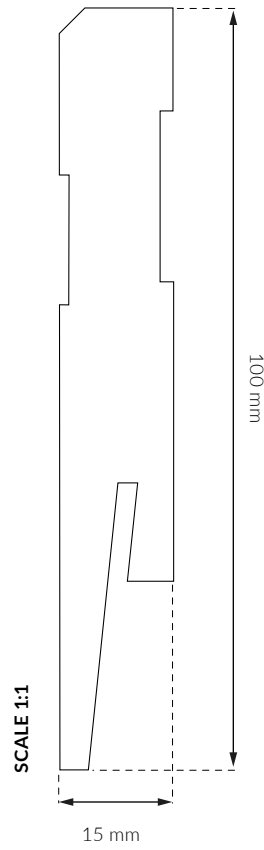

**White**

MP1002 | 5905167674383  
 24,2 m

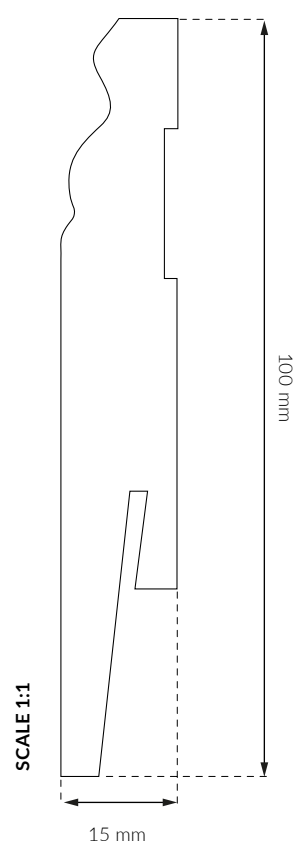

**White**

MP1003 | 5905167674390  
 24,2 m

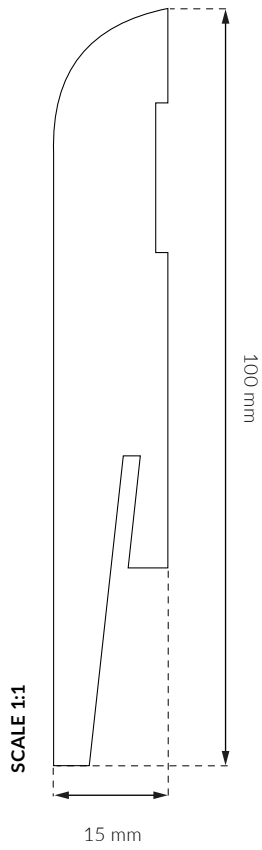

**White**  
 MP1004 | 5905167674406  
 24,2 m

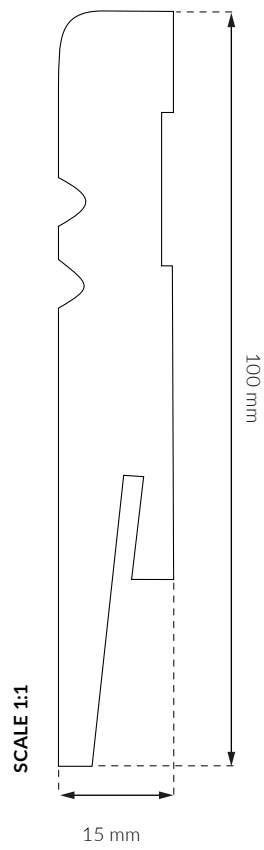

**White**  
 MP1005 | 5905167674413  
 24,2 m

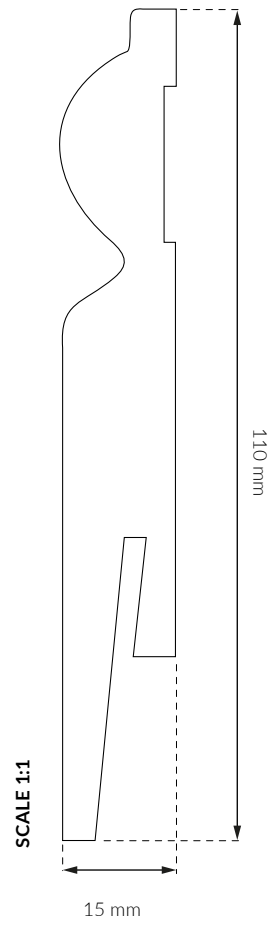







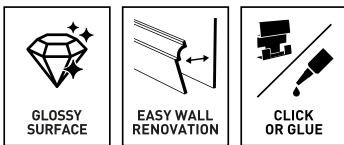

**White**  
 MP1101 | 5905167674420  
 24,2 m





# DIAMOND



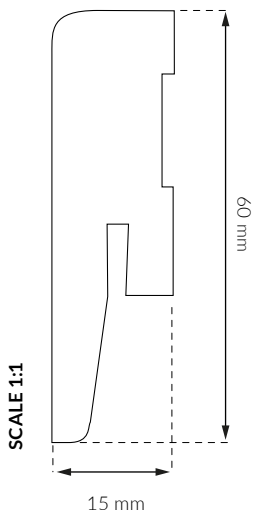

- GLOSSY SURFACE
- EASY WALL RENOVATION
- CLICK OR GLUE

					
	SKIRTING	BLOCKS	CLIPS AND DOWELS	STRONGMAN GLUE	ACRYLIC
	242 cm	1,8x1,8x11,2 cm	ø 6 mm	-	-
	-	4 pcs = 1 set	25 pcs	1 pc	1 pc
	24,2 m	10 sets	1500 pcs	12 pcs	12 pcs
EAN		5905167736937	5905167674437	5905167788264	5907584890193

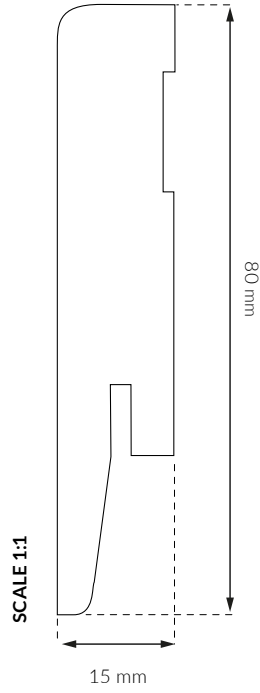

**White**  
 GP0601 | 5905167766668  
 21,8 m



**White**  
 GP0801 | 5905167766675  
 24 m

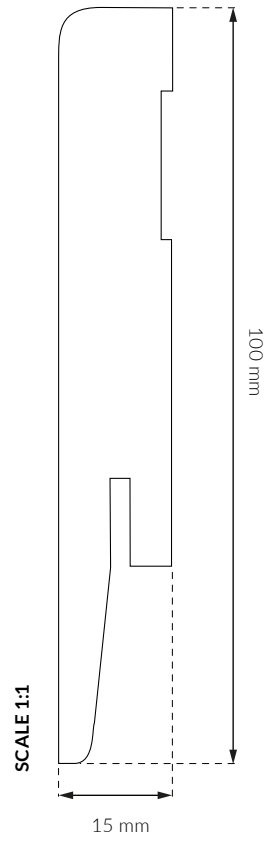

**White**  
 GP1001 | 5905167766682  
 24 m

ACCESSORIES / UNIVERSAL BLOCK

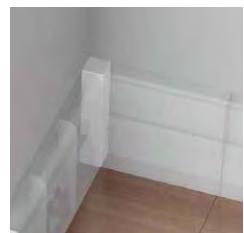
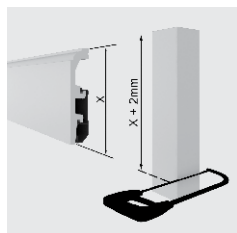
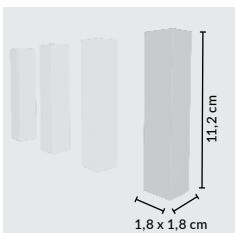

# UNIVERSAL PROFILE



00 | Black    01 | White    03 | Beech    04 | White beech    07 | Dark oak    08 | White Oak    11 | Grey Ash    12 | Mahogany

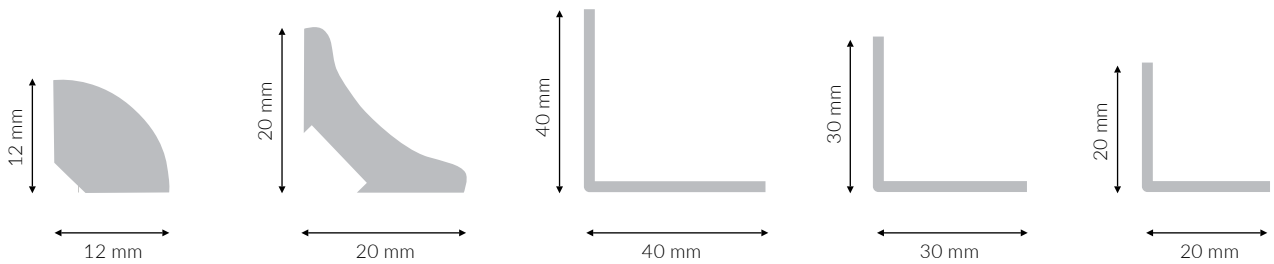

## LC

QUARTER ROUND PROFILE

00	5907584871017
01	5907584871024
02	5907584871055
04	5907584871048
08	5907584871062
11	5907584871031

## LN

CORNER PROFILE

00	5907584871109
01	5907584871116
02	5907584871147
04	5907584871130
08	5907584871154
11	5907584871123

## LK

ANGLE BARS WITH BOTH SIDES PRINTED

00	5907584871208
01	5907584871215
02	5907584871246
07	5907584871222
08	5907584871239
11	5907584871253
12	5906735622478

00	5907584871307
01	5907584871314
02	5907584871345
07	5907584871321
08	5907584871338
11	5907584871352
12	5906735622485

00	5907584871406
01	5907584871413
02	5907584871444
07	5907584871420
08	5907584871437
11	5907584871451
12	5906735622492

	2,5 m
	50 m

	2,5 m
	50 m

	2,75 m
	55 m





	2,75 m
	55 m

	2,75 m
	55 m

# ACCESSORIES







## CLIPS AND DOWEL FOR TORE, VIGO, MDF COLLECTION

 / 	ø 6 mm
	20 pcs
	1200 pcs
EAN	5905167826737







## TAPE

 / 	-
	1 pc
	24 pcs
EAN	5905167731444







## STRONGMAN GLUE

 / 	-
	1 pc / 300 ml
	12 pcs
EAN	5905167788264







## ACRYL





 / 	-
	1 pc / 300 ml
	12 pcs
EAN	5907584890193



## BLOCKS FOR VEGA

 / 	2,3x2,3x15,2 cm
	4 pcs = 1 set
	10 sets
EAN	5905167746844

## BLOCKS FOR MDF

 / 	1,8x1,8x11,2 cm
	4 pcs = 1 set
	10 sets
EAN	5905167736937



# SYMBOLS



**100% WATERPROOF**  
Clean your floor without any risk – non-deforming, water resistant board!



**FLEXIBLE**  
Flexible adaptation to uneven walls.



**IMPACT RESISTANT**  
Highest resistance and stability.

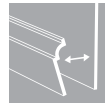

**EASY WALL RENOVATION**  
Possibility of unfixing skirtings in order to paint or hide TV or audio cable (max 230V).



**KEEP IT WHITE OR PAINT IT**  
The board which can be painted. Possibility of fully matching the board colours to the walls of the room.



**4 WAY SYSTEM**  
Solid, fast, simple installation and deinstallation, for any type of wall.



**GLOSSY SURFACE**  
Brilliant shiny finishing.

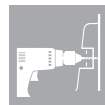

**EASY INSTALLATION**  
Wide installation channel provides an easy access for a drill or screwdriver. It makes installation quicker and easier.



**WOOD EFFECT**  
The ideal colour and design match, 100% accurate representation of wooden colors.



**MITRE SAW**  
The possibility of cutting corners with a mitre saw.



**MANUAL CUTTING**  
The possibility of cutting corners with a hand saw.



**DUST AND DIRT BARRIER**  
Smooth surface without micropores and harder COEX is perfect for easy cleaning and non adhering dirt and dust.



**CLICK OR GLUE**  
Install the skirting in two ways: glue skirting directly to the wall, or clip - strip easily and remove at any time.



**MODERN DESIGN**  
Unique shape was created for a modern interiors and its simplicity is an answer even for the most demanding.



**WOOD STRUCTURE**  
Structure embossed on the surface, perfectly imitating the real wood.



**JUST GLUE**  
Glue skirting directly to the wall.



### DEEP MATT

Thanks to totally new, multi-step process of production we get a deep matt surface.



### SUPER FLEXIBLE

Flexible adaptation to uneven walls.



### GLUING CHANNEL

special glue channel to prevent the excess of glue from slipping out.



### NO SILICONE NEEDED

Integrated and large rubber edges in the color of the skirting adapts to uneven surfaces and gives a solid connection with the wall and the floor resulting in 100% waterproof barrier

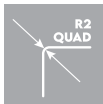

### R2 DESIGN = 2mm



### DIGITAL DESIGN

Due to the highly advanced technology of digital printing - piezoelectric UV LED with high-resolution (up to 1800 dpi)



**HYBRID**  
TECHNOLOGY

### HYBRID TECHNOLOGY

The product that combines the advantages of polymer products, like impact resistance and waterproof with high quality surface of lacquered MDF skirtings.



### ECO FRIENDLY

The board made of environmentally friendly material.



### 100% PVC FREE

The board made of environmentally friendly material.



### MDF

Skirting board made from MDF covered with coated paper which increases durability. It's not necessary to paint the skirting board before the first installation.



### PATENTED

Our technology is patented



The materials awarded this label comply with very stringent health and environmental requirements.



The materials awarded this label comply with very stringent health and environmental requirements.



Decora S.A.  
ul. Prądyńskiego 24a  
63-000 Środa Wlkp., Polska  
tel.: +48 61 28 64 200  
fax: +48 61 28 54 975  
e-mail: sales@decora.pl  
www.arbiton.com

### CHECK OUR COMPLEMENTARY PRODUCTS



The catalogue is a free of charge presentation of products of Decora S.A. and acc. to valid law it is not a commercial offer. Colors and textures of the products in pictures may differ from real ones because of limited printing technologies. Decora S.A. reserves its right to alter availability of the products on some markets and at some distributors. The products included in the catalogues do not pose a complete offer of Decora S.A.

