



2019

KATALOG
KLAMEK

WITAJ
W DOMU.





ZARZĄDZANIE JAKOŚCIĄ
Jesteśmy certyfikowani
według wymagań
ISO 9001:2015



PRZEDSIĘBIORSTWO
FAIR PLAY

Posiadamy Certyfikat
Jakości Biznesu,
którego celem jest
m.in. propagowanie idei
etycznego postępowania
w relacjach biznesowych.



Jesteśmy firmą rodzinną
od ponad 30 lat.



Kupując nasze produkty
wspierasz opracowanie
protezy serca dla dzieci.

SZANOWNI PAŃSTWO,

CHCIELIŚMY ZAPROSIĆ PAŃSTWA DO ŚWIATA
NASZYCH KLAMEK, W KTÓRYM DOMINUJE
RÓŻNORODNOŚĆ STYLÓW, Z ZACHOWANIEM
BEZPIECZEŃSTWA I NAJWYŻSZEJ JAKOŚCI.

W katalogu zamieściliśmy zarówno klasyczne, jak i nowoczesne wzory okuć drzwiowych, aby dać Państwu możliwość komfortowej aranżacji wnętrza. Bazując na naszym wieloletnim doświadczeniu i opinii dziesiątek klientów, stworzyliśmy ofertę, kreując tym samym trendy we wzornictwie klamek.

Niebanalny design znajdą Państwo w każdej z naszych klamek do drzwi. Oferujemy dużą różnorodność wśród kolorów, rodzajów i kształtów. Wykonane one zostały z mosiądzu, aluminium lub stali nierdzewnej i znanu, a szlifowanie i poddanie obróbce galwanicznej, dodało im odporności na ścieranie oraz unikalne właściwości kolorystyczne i efekty estetyczne.

Naszą ofertę uzupełniliśmy o wizjery, zawiasy, zamki, wkładki, odbojniki, tuleje do drzwi łazienkowych i wiele innych elementów z zakresu okuć drzwiowych, produkowanych przez renomowane firmy zachodnie. Wszystkie klamki dostępne w Domino posiadają certyfikat zgodności z PN EN 1906, wydany przez Instytut Techniki Budowlanej w Poznaniu, uprawniający do ich stosowania w budownictwie.

Gwarantujemy Państwu terminowość dostaw, fachowe doradztwo i najwyższą jakość produktów.

NASZE KLAMKI OTWIERAJĄ KAŻDE DRZWI,
TAKŻE TE DO WYOBRAŹNI!

Serdecznie zapraszamy!

Zofia i Eugeniusz Świszcz
DOMINO Polska



SALON W DZIERŻONIOWIE
UL. RZEŹNICZA 4, DZIERŻONIÓW

GODZINY OTWARCIA:
od poniedziałku - do piątku: 8:00 - 18:00
sobota: 9:00 - 16:00

DANE KONTAKTOWE:
tel. 74 832 48 03
fax. 74 832 48 04
kom: 609 830 666
e-mail: detal@domino.pl

SALON W LUBINIE
UL. LEGNICKA 69B, LUBIN

GODZINY OTWARCIA:
od poniedziałku - do piątku: 8:00 - 19:00
sobota: 9:00 - 16:00

DANE KONTAKTOWE:
tel. 74 832 48 71
fax. 74 832 34 04
kom: 885 552 355
e-mail: lubin@domino.pl



RODZINA

JESTEŚMY FIRMĄ RODZINNĄ, KTÓRA DOSKONAŁE ZNA ZRÓŻNICOWANE POTRZEBY DOMOWNIKÓW. ODPOWIADAMY NA NIE TWORZĄC PRAKTYCZNY SZCZEGÓŁ - KLAMKĘ, BEZ KTÓREJ ANI RUSZI!



NAJWYŻSZA JAKOŚĆ

OD CZASU POWSTANIA FIRMY JEDNYM Z NASZYCH CELÓW BYŁO DOSTARCZANIE PRODUKTÓW NAJWYŻSZEJ JAKOŚCI. NASZE KLAMKI WYPOSAŻONE SĄ W TRWAŁE MECHANIZMY, PRZEZ CO BĘDZIESZ MÓGŁ ZA NIE POCIĄGNĄĆ WIELE, WIELE RAZY.

SZACUNEK

MOŻEMY POCHWALIĆ SIĘ BOGATĄ KOLEKCJĄ KLAMEK, KTÓRE POWSTAŁY Z SZACUNKU DO ROZMAITYCH GUSTÓW I OCZEKIWAŃ. NIE BRAKUJE NAWIĄZAŃ DO TRADYCJI, JAK RÓWNIEŻ PROJEKTÓW ZGODNYCH Z NAJNOWSZYMI TRENDAMI.



ZAANGAŻOWANIE

POMIĘDZY PRACĄ ZNAJDUJEMY CZAS, ŻEBY ZAANGAŻOWAĆ SIĘ W PROJEKTY, KTÓRE NIOSĄ POMOC INNYM. WSPÓŁPRACUJEMY NA STAŁE Z FUNDACJĄ ZBIGNIEWA RELIGII, PRZYGOTOWUJEMY SZLACHETNE PACZKI A JEDNOCZEŚNIE ANGAŻUJEMY SIĘ W POMOC LOKALNYM SPOŁECZNOŚCIOM.



DOŚWIADCZENIE

OD PONAD 30 LAT TWORZYMY PRODUKTY I ROZWIĄZANIA DLA DOMU. TYLE LAT OBECNOŚCI NA RYNKU SPRAWIA, ŻE POTRAFIMY DOSKONAŁE OKREŚLAĆ WSZYSTKIE POTRZEBY NASZYCH KLIENTÓW I CZERPAĆ Z TRADYCJI TO, CO NAJWAŻNIEJSZE DLA NOWOCZESNYCH DOMÓW.



ZAUFIANIE

WIEMY, ŻE ZAUFIANIE W RODZINIE JEST NAJWAŻNIEJSZE, DLATEGO JEST TO PRIORYTET KAŻDEJ NASZEJ RELACJI. TWORZYMY NIEZAWODNE PRODUKTY, KTÓRE ZNAKOMICIE ODGRYWAJĄ SWOJĄ ROLĘ W MILIONACH DOMÓW W EUROPIE.



HARMONIA

HARMONIA JEST NASZĄ RECEPTĄ NA WYDOBYCIE PIĘKNA Z TWOICH POMIESZCZEŃ. OFEROWANY PRZEZ NAS SZEROKI WYBÓR KLAMEK POZWOLI CI DOBRAĆ PRODUKTY IDEALNIE DOPASOWANE DO CIEBIE I TWOJEGO WNĘTRZA.

A WSZYSTKO PO TO,
ABYŚ ZAPROSIŁ NAS
DO NAJWAŻNIEJSZEGO
MIEJSCA NA CAŁYM
ŚWIECIE.

WITAJ
W DOMU.



ŚWIAT STOI U TWOICH DRZWI.
MY DOKŁADAMY
TYLKO JEDEN SZCZEGÓŁ.





LEGENDA



NOWOŚĆ



SUPER CENA



DESIGN



DO WYCZERPANIA



DO UŻYTKU PUBLICZNEGO



KLAMKA NA INWESTYCJE



CERTYFIKAT EI 30

RODZAJE DOSTĘPNYCH
KLAMEK

KLAMKI
NA DZIELONYM
SZYLDZIE
KWADRATOWYM

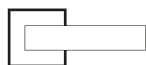

s. 6

KLAMKI
NA DZIELONYM
SZYLDZIE
OKRĄGLYM

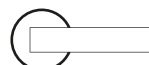

s. 32

KLAMKI
NA
DŁGIM
SZYLDZIE

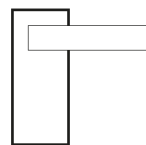

s. 68

KLAMKI
ZE STALI
NIERDZEWNEJ

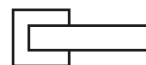

s. 78

KLAMKI
NA DZIELONYM
SZYLDZIE
SLIM



s. 82

SZYLDY



s. 86

GAŁKI



s. 94

KLAMKI
DO DRZWI
ZEWNĘTRZNYCH

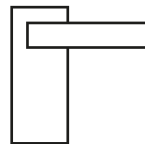

s. 98

KLAMKI
BRAMOWE

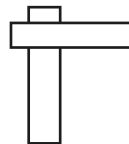

s. 103

KLAMKI
OKIENNE



s. 104

AKCESORIA

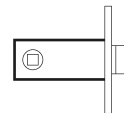

s. 106

RODZAJ
SZYLDU

BB - KLUCZ

PZ - WKŁADKA BĘBENKOWA

WC - ŁAZIENKA

FORMY
PRZEBIĆ

BB - KLUCZ

PZ - WKŁADKA BĘBENKOWA

B/O - BEZ OTWORU

WC - ŁAZIENKA

LEWA/PRAWA - STRONA

WSZYSCY
ROZUMIEMY SIĘ
BEZ SŁÓW.



KLAMKI NA DZIELONYM
SZYLDZIE KWADRATOWYM

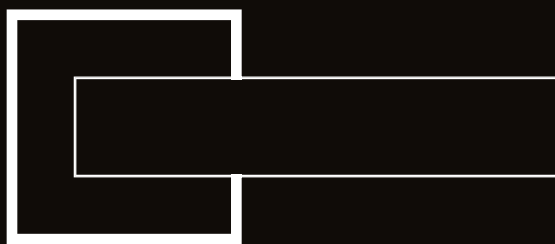

KLAMKI WEWNĘTRZNE | KLAMKI NA DZIELONYM SZYLDZIE KWADRATOWYM

Alma - QR



domino®



SN



SN

Szyld Alma-QR

| | Netto | Brutto |
|-----------------|-------|--------|
| Klamka dzielona | 42,93 | 52,80 |
| Szyld BB PZ | 16,99 | 20,90 |
| Szyld WC | 23,01 | 28,30 |

Baltic - QR

domino®



M6/M9



M6/M9

Szyld Quadro-QR

| | Netto | Brutto |
|-----------------|-------|--------|
| Klamka dzielona | 67,56 | 83,10 |
| Szyld BB PZ | 19,59 | 24,10 |
| Szyld WC | 27,24 | 33,50 |

Coral - QR



domino®



M9



M9

Szyld Quadro-QR

| | Netto | Brutto |
|-----------------|-------|--------|
| Klamka dzielona | 29,11 | 35,80 |
| Szyld BB PZ | 19,59 | 24,10 |
| Szyld WC | 27,24 | 33,50 |

Cube - RT

domino®



M9/Black M9/Red M9/White



M9

Szyld RT

| | Netto | Brutto |
|-----------------|-------|--------|
| Klamka dzielona | 76,75 | 94,40 |
| Szyld BB PZ | 21,38 | 26,30 |
| Szyld WC | 26,99 | 33,20 |

Eris - QR



domino®



M6/M9



M6/M9

Szyld Quanta-QR

| | Netto | Brutto |
|-----------------|-------|--------|
| Klamka dzielona | 46,02 | 56,60 |
| Szyld BB PZ | 19,59 | 24,10 |
| Szyld WC | 27,24 | 33,50 |

Ene - QR

domino®



M6/M9



M6/M9

Szyld KW-QR

| | Netto | Brutto |
|-----------------|-------|--------|
| Klamka dzielona | 34,72 | 42,70 |
| Szyld BB PZ | 19,59 | 24,10 |
| Szyld WC | 27,24 | 33,50 |



Fokus - QR

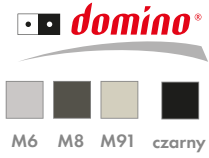

M8



M6



M91



czarny

Szylid Quadro-QR



| | Netto | Brutto |
|-----------------|-------|--------|
| Klamka dzielona | 42,93 | 52,80 |
| Szylid BB PZ | 19,59 | 24,10 |
| Szylid WC | 27,24 | 33,50 |

Fero-QR

M91



M91

Szyld Quadro-QR



| | Netto | Brutto |
|-----------------|--------------|--------|
| Klamka dzielona | 29,11 | 35,80 |
| Szyld BB PZ | 19,59 | 24,10 |
| Szyld WC | 27,24 | 33,50 |

Figo-QR

M91



M91

Szyld Quadro-QR



| | Netto | Brutto |
|-----------------|--------------|--------|
| Klamka dzielona | 30,65 | 37,70 |
| Szyld BB PZ | 19,59 | 24,10 |
| Szyld WC | 27,24 | 33,50 |

Fremo-QR

M9 M91 czarny



M9 M91

Szyld Quadro-QR



| | Netto | Brutto |
|-----------------|--------------|--------|
| Klamka dzielona | 19,84 | 24,40 |
| Szyld BB PZ | 19,59 | 24,10 |
| Szyld WC | 27,24 | 33,50 |

Galaxy-QR

M6/M9



M6/M9

Szyld Quadro-QR



| | Netto | Brutto |
|-----------------|--------------|--------|
| Klamka dzielona | 43,33 | 53,30 |
| Szyld BB PZ | 19,59 | 24,10 |
| Szyld WC | 27,24 | 33,50 |

Insignia-QR

M6/M9



M9

Szyld Quadro-QR

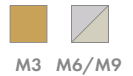

| | Netto | Brutto |
|-----------------|--------------|--------|
| Klamka dzielona | 40,08 | 49,30 |
| Szyld BB PZ | 19,59 | 24,10 |
| Szyld WC | 27,24 | 33,50 |

Jane-QR

M3 M6/M9



M3 M9

Szyld Quadro-QR



| | Netto | Brutto |
|-----------------|--------------|--------|
| Klamka dzielona | 61,38 | 75,50 |
| Szyld BB PZ | 19,59 | 24,10 |
| Szyld WC | 27,24 | 33,50 |

Jaro-QR eco

M6/M9



M6/M9

Szyld Quadro-QR



| | Netto | Brutto |
|-----------------|--------------|--------|
| Klamka dzielona | 44,63 | 54,90 |
| Szyld BB PZ | 19,59 | 24,10 |
| Szyld WC | 27,24 | 33,50 |

Jaro-QR

M6/M9



M6/M9

Szyld Quadro-QR



| | Netto | Brutto |
|-----------------|--------------|--------|
| Klamka dzielona | 65,28 | 80,30 |
| Szyld BB PZ | 19,59 | 24,10 |
| Szyld WC | 27,24 | 33,50 |



Joon - QR



M6/M9



Szyld Quanta-QR

M6/M9



| | Netto | Brutto |
|-----------------|-------|--------|
| Klamka dzielona | 45,93 | 56,50 |
| Szyld BB PZ | 19,59 | 24,10 |
| Szyld WC | 27,24 | 33,50 |

Kyrk - QR



domino®



M6/M9 czarny



M6/M9 czarny

Szyld Quadro-QR



Netto Brutto

| | | |
|-----------------|-------|-------|
| Klamka dzielona | 30,65 | 37,70 |
| Szyld BB PZ | 19,59 | 24,10 |
| Szyld WC | 27,24 | 33,50 |

Line - RT



domino®



M9 czarny



M9 czarny

Szyld RT



Netto Brutto

| | | |
|-----------------|-------|-------|
| Klamka dzielona | 46,02 | 56,60 |
| Szyld BB PZ | 21,38 | 26,30 |
| Szyld WC | 26,99 | 33,20 |

Logo - QR

domino®



M3 M6 M9



M3 M6 M9

Szyld Quadro-QR



Netto Brutto

| | | |
|-----------------|-------|-------|
| Klamka dzielona | 66,02 | 81,20 |
| Szyld BB PZ | 19,59 | 24,10 |
| Szyld WC | 27,24 | 33,50 |



Maff-QR



domino

M6/Antracyt M6/M9

M6/Antracyt M6/M9

Szyld Quanta-QR

| | Netto | Brutto |
|-----------------|-------|--------|
| Klamka dzielona | 42,93 | 52,80 |
| Szyld BB PZ | 19,59 | 24,10 |
| Szyld WC | 27,24 | 33,50 |

Milano-QR

domino



M9

M9

Szyld Quadro-QR

| | Netto | Brutto |
|-----------------|-------|--------|
| Klamka dzielona | 69,11 | 85,00 |
| Szyld BB PZ | 19,59 | 24,10 |
| Szyld WC | 27,24 | 33,50 |

Modena-QR

domino

M9



M9

Szyld Quadro-QR

| | Netto | Brutto |
|-----------------|-------|--------|
| Klamka dzielona | 53,66 | 66,00 |
| Szyld BB PZ | 19,59 | 24,10 |
| Szyld WC | 27,24 | 33,50 |

Milo-QR

ZŁ SUPER CENA DESIGN

domino

M6/M9



M6/M9

Szyld Quanta-QR

| | Netto | Brutto |
|-----------------|-------|--------|
| Klamka dzielona | 42,93 | 52,80 |
| Szyld BB PZ | 19,59 | 24,10 |
| Szyld WC | 27,24 | 33,50 |

Nemo-QR

domino

M9



M9

Szyld Quadro-QR

| | Netto | Brutto |
|-----------------|-------|--------|
| Klamka dzielona | 34,72 | 42,70 |
| Szyld BB PZ | 19,59 | 24,10 |
| Szyld WC | 27,24 | 33,50 |

Minimal-RT

domino



M9

M9

Szyld RT

| | Netto | Brutto |
|-----------------|-------|--------|
| Klamka dzielona | 76,75 | 94,40 |
| Szyld BB PZ | 21,38 | 26,30 |
| Szyld WC | 26,99 | 33,20 |



Quanta-QR

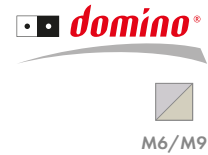

M6/M9



Szyld Quanta-QR

| | Netto | Brutto |
|-----------------|--------------|--------|
| Klamka dzielona | 44,47 | 54,70 |
| Szyld BB PZ | 19,59 | 24,10 |
| Szyld WC | 27,24 | 33,50 |

Omega-QR



M9



M9

Szyld Quadro-QR



| | Netto | Brutto |
|-----------------|--------------|--------|
| Klamka dzielona | 44,47 | 54,70 |
| Szyld BB PZ | 19,59 | 24,10 |
| Szyld WC | 27,24 | 33,50 |

Palermo-QR



M9



M9

Szyld Quadro-QR



| | Netto | Brutto |
|-----------------|--------------|--------|
| Klamka dzielona | 56,10 | 69,00 |
| Szyld BB PZ | 19,59 | 24,10 |
| Szyld WC | 27,24 | 33,50 |

Presto-QR



M6/M9



M9

Szyld Quadro-QR



| | Netto | Brutto |
|-----------------|--------------|--------|
| Klamka dzielona | 43,58 | 53,60 |
| Szyld BB PZ | 19,59 | 24,10 |
| Szyld WC | 27,24 | 33,50 |



Qubik - QR

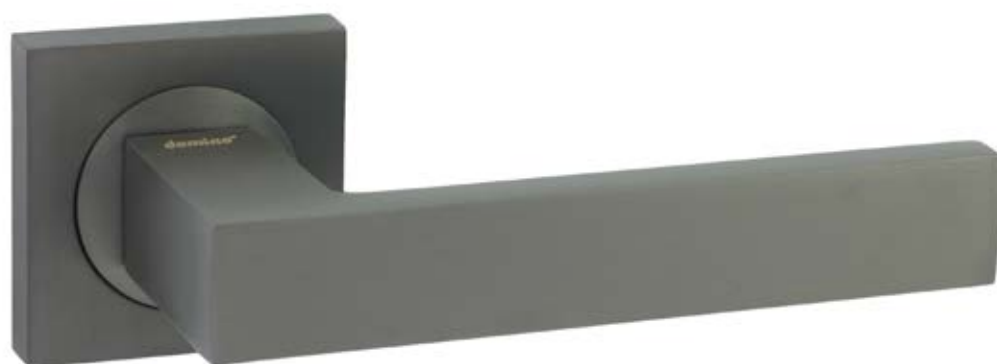

M8



M6



M9



M91



czarny

Szyld Quadro-QR



| | Netto | Brutto |
|-----------------|-------|--------|
| Klamka dzielona | 46,50 | 57,20 |
| Szyld BB PZ | 19,59 | 24,10 |
| Szyld WC | 27,24 | 33,50 |



Real - QR



Szyld KW-QR



| | Netto | Brutto |
|-----------------|-------|--------|
| Klamka dzielona | 42,52 | 52,30 |
| Szyld BB PZ | 19,59 | 24,10 |
| Szyld WC | 27,24 | 33,50 |

Romana - QR



M6/M9

Szyld Quadro-QR



| | Netto | Brutto |
|-----------------|-------|--------|
| Klamka dzielona | 36,26 | 44,60 |
| Szyld BB PZ | 19,59 | 24,10 |
| Szyld WC | 27,24 | 33,50 |

Sky - QR



M6/M9

Szyld Quadro-QR



| | Netto | Brutto |
|-----------------|-------|--------|
| Klamka dzielona | 61,38 | 75,50 |
| Szyld BB PZ | 19,59 | 24,10 |
| Szyld WC | 27,24 | 33,50 |

Time - QR



M3 M6 M9

Szyld Quadro-QR

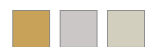

| | Netto | Brutto |
|-----------------|-------|--------|
| Klamka dzielona | 71,87 | 88,40 |
| Szyld BB PZ | 19,59 | 24,10 |
| Szyld WC | 27,24 | 33,50 |

Tool-QR

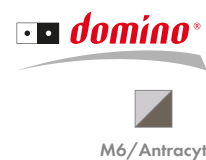

Szyld Quanta-QR

M6/Antracyt



| | Netto | Brutto |
|-----------------|-------|--------|
| Klamka dzielona | 45,77 | 56,30 |
| Szyld BB PZ | 19,59 | 24,10 |
| Szyld WC | 27,24 | 33,50 |

Twist-RT

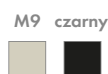

Szyld RT

| | Netto | Brutto |
|-----------------|-------|--------|
| Klamka dzielona | 30,65 | 37,70 |
| Szyld BB PZ | 21,38 | 26,30 |
| Szyld WC | 26,99 | 33,20 |

Tre-QR



Szyld Quadro-QR

| | Netto | Brutto |
|-----------------|-------|--------|
| Klamka dzielona | 29,11 | 35,80 |
| Szyld BB PZ | 19,59 | 24,10 |
| Szyld WC | 27,24 | 33,50 |



TWORZYM
NAJPIĘKNIJSZĄ
CODZIENNOŚĆ.



2

KLAMKI NA DZIELONYM
SZYLDZIE KWADRATOWYM

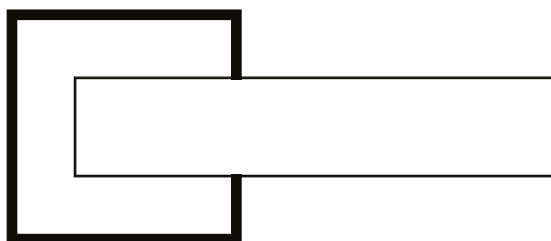

PREMIUM

PREMIUM



KLAMKI WEWNĘTRZNE | KLAMKI NA DZIELONYM SZYLDZIE KWADRATOWYM

Andy - QR

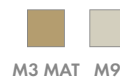

Szyld Oro-QR

M3 MAT M9



| | Netto | Brutto |
|-----------------|--------|--------|
| Klamka dzielona | 107,56 | 132,30 |
| Szyld BB PZ | 21,06 | 25,90 |
| Szyld WC | 26,75 | 32,90 |

Biblo - QR



| | Netto | Brutto |
|----------------|--------|--------|
| Klamka BB PZ | 203,09 | 249,80 |
| Klamka WC | 251,71 | 309,60 |

Delux - QR



M9



Szyld Oro-QR

M9



| | Netto | Brutto |
|-----------------|--------|--------|
| Klamka dzielona | 107,56 | 132,30 |
| Szyld BB PZ | 21,06 | 25,90 |
| Szyld WC | 26,75 | 32,90 |

Diana - QR



M4 M6 M9



Szyld B04-QR

M4 M6 M9



| | Netto | Brutto |
|-----------------|--------|--------|
| Klamka dzielona | 108,13 | 133,00 |
| Szyld BB PZ | 24,47 | 30,10 |
| Szyld WC | 41,38 | 50,90 |

Electra-QR Cristal



Szyld 546-Q

M7/M9



| | Netto | Brutto |
|-----------------|--------|--------|
| Klamka dzielona | 415,37 | 510,90 |
| Szyld BB PZ | 49,11 | 60,40 |
| Szyld WC | 109,92 | 135,20 |

Eliza-QR



Szyld B04-QR

M4 M6 M9



| | Netto | Brutto |
|-----------------|--------|--------|
| Klamka dzielona | 112,20 | 138,00 |
| Szyld BB PZ | 24,47 | 30,10 |
| Szyld WC | 41,38 | 50,90 |

E t a r - Q R



M6/Black



| | Netto | Brutto |
|----------------|--------|--------|
| Klamka BB PZ | 198,46 | 244,10 |
| Klamka WC | 216,91 | 266,80 |

F r a m e - Q R



M4



| | Netto | Brutto |
|----------------|--------|--------|
| Klamka BB PZ | 340,00 | 418,20 |
| Klamka WC | 370,81 | 456,10 |

Gazela-QR



Szyld Oro-QR

M9



| | Netto | Brutto |
|-----------------|--------|--------|
| Klamka dzielona | 183,09 | 225,20 |
| Szyld BB PZ | 21,06 | 25,90 |
| Szyld WC | 26,75 | 32,90 |

Helena-QR



M1/M2 M7/M9



Szyld 546-Q

M1/M2 M7/M9



| | Netto | Brutto |
|-----------------|--------|--------|
| Klamka dzielona | 293,25 | 360,70 |
| Szyld BB PZ | 49,11 | 60,40 |
| Szyld WC | 109,92 | 135,20 |

J e z z - Q R



| | Netto | Brutto |
|----------------|--------|--------|
| Klamka BB PZ | 198,46 | 244,10 |
| Klamka WC | 216,91 | 266,80 |

L i v a - Q R



| | Netto | Brutto |
|----------------|--------|--------|
| Klamka BB PZ | 198,46 | 244,10 |
| Klamka WC | 216,91 | 266,80 |

Maya - QR



M3 MAT M9

Szyld Oro-QR



| | Netto | Brutto |
|-----------------|--------|--------|
| Klamka dzielona | 107,56 | 132,30 |
| Szyld BB PZ | 21,06 | 25,90 |
| Szyld WC | 26,75 | 32,90 |

Maya - QR Cristal



M9

Szyld Oro-QR



| | Netto | Brutto |
|-----------------|--------|--------|
| Klamka dzielona | 183,09 | 225,20 |
| Szyld BB PZ | 21,06 | 25,90 |
| Szyld WC | 26,75 | 32,90 |

Magnet - QR



M3 MAT M9

Szydł Oro-QR



| | Netto | Brutto |
|-----------------|--------|--------|
| Klamka dzielona | 107,56 | 132,30 |
| Szydł BB PZ | 21,06 | 25,90 |
| Szydł WC | 26,75 | 32,90 |

Navy - QR



| | Netto | Brutto |
|----------------|--------|--------|
| Klamka BB PZ | 290,16 | 356,90 |
| Klamka WC | 338,70 | 416,60 |

Pira - QR



| | Netto | Brutto |
|----------------|--------|--------|
| Klamka BB PZ | 198,46 | 244,10 |
| Klamka WC | 216,91 | 266,80 |

Quezo - QR



| | Netto | Brutto |
|----------------|--------|--------|
| Klamka BB PZ | 198,46 | 244,10 |
| Klamka WC | 216,91 | 266,80 |

Rainbow-QR



M9

Szyld Oro-QR



| | Netto | Brutto |
|-----------------|--------|--------|
| Klamka dzielona | 183,09 | 225,20 |
| Szyld BB PZ | 21,06 | 25,90 |
| Szyld WC | 26,75 | 32,90 |

Sedar-QR



| | Netto | Brutto |
|----------------|--------|--------|
| Klamka BB PZ | 198,46 | 244,10 |
| Klamka WC | 216,91 | 266,80 |

Tiger - QR



M91/Black M91/Red



Szyld Oro-QR

M91



| | Netto | Brutto |
|-----------------|--------|--------|
| Klamka dzielona | 183,09 | 225,20 |
| Szyld BB PZ | 21,06 | 25,90 |
| Szyld WC | 26,75 | 32,90 |

Tora - QR



M6 M9



| | Netto | Brutto |
|----------------|--------|--------|
| Klamka BB PZ | 198,46 | 244,10 |
| Klamka WC | 216,91 | 266,80 |

Vittoria-QR

BINALIA



Szyld B04-QR

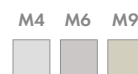

| | Netto | Brutto |
|-----------------|--------|--------|
| Klamka dzielona | 101,06 | 124,30 |
| Szyld BB PZ | 24,47 | 30,10 |
| Szyld WC | 41,38 | 50,90 |

Toro-QR

DO
WYCZERPANIA

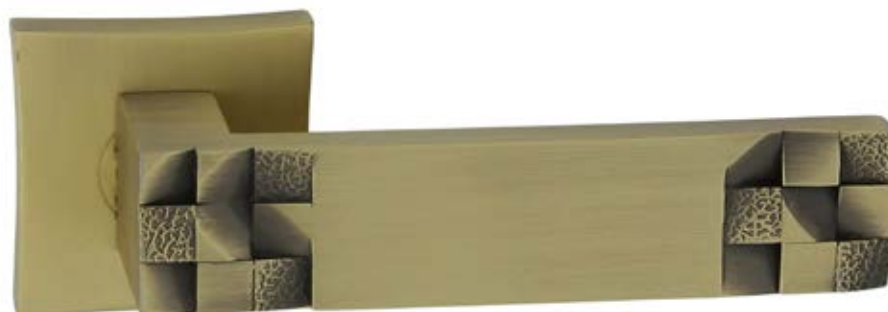

Szyld Oro-QR

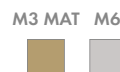

| | Netto | Brutto |
|-----------------|--------|--------|
| Klamka dzielona | 107,56 | 132,30 |
| Szyld BB PZ | 21,06 | 25,90 |
| Szyld WC | 26,75 | 32,90 |

Vertigo - QR



| | Netto | Brutto |
|----------------|--------|--------|
| Klamka BB PZ | 358,46 | 440,90 |
| Klamka WC | 407,15 | 500,80 |

Yoda - QR



| | Netto | Brutto |
|----------------|--------|--------|
| Klamka BB PZ | 198,46 | 244,10 |
| Klamka WC | 216,91 | 266,80 |

Easy-QR slim



Szyld Prime-QR



| | Netto | Brutto |
|-----------------------------|--------|--------|
| Klamka dzielona Czarny M4 | 153,66 | 189,00 |
| Klamka dzielona M6 | 161,79 | 199,00 |
| Szyld BB PZ Czarny | 30,00 | 36,90 |
| Szyld BB PZ M4 M6 | 32,44 | 39,90 |
| Szyld WC Czarny | 56,10 | 69,00 |
| Szyld WC M4 M6 | 64,23 | 79,00 |

Primus-QR slim



Szyld Prime-QR

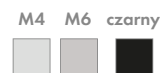

| | Netto | Brutto |
|------------------------|--------|--------|
| Klamka dzielona Czarny | 129,27 | 159,00 |
| Klamka dzielona M6 | 137,40 | 169,00 |
| Klamka dzielona M4 | 145,53 | 179,00 |
| Szyld BB PZ Czarny | 30,00 | 36,90 |
| Szyld BB PZ M4 M6 | 32,44 | 39,90 |
| Szyld WC Czarny | 56,10 | 69,00 |
| Szyld WC M4 M6 | 64,23 | 79,00 |

York-QR slim



M4 M6 czarny



Szyld Prime-QR

| | Netto | Brutto |
|------------------------|---------------|--------|
| Klamka dzielona Czarny | 129,27 | 159,00 |
| Klamka dzielona M6 | 137,40 | 169,00 |
| Klamka dzielona M4 | 153,66 | 189,00 |
| Szyld BB PZ Czarny | 30,00 | 36,90 |
| Szyld BB PZ M4 M6 | 32,44 | 39,90 |
| Szyld WC Czarny | 56,10 | 69,00 |
| Szyld WC M4 M6 | 64,23 | 79,00 |

TROSZCZYMY SIĘ
O SIEBIE OD RANA
DO NOCY.

3



KLAMKI NA DZIELONYM
SZYLDZIE OKRĄGŁYM

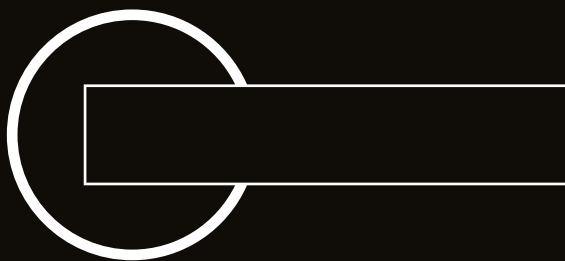

Afrodyta - R



M3

Szyld 900

| | Netto | Brutto |
|-----------------|--------------|--------|
| Klamka dzielona | 61,38 | 75,50 |
| Szyld BB PZ | 13,58 | 16,70 |
| Szyld WC | 21,38 | 26,30 |

Alma - R eco

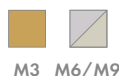

M3 M6/M9

Szyld 950

| | Netto | Brutto |
|-----------------|--------------|--------|
| Klamka dzielona | 32,68 | 40,20 |
| Szyld BB PZ | 13,58 | 16,70 |
| Szyld WC | 21,38 | 26,30 |

Ballen - R



M3 M9

Szyld 950

| | Netto | Brutto |
|-----------------|--------------|--------|
| Klamka dzielona | 31,71 | 39,00 |
| Szyld BB PZ | 13,58 | 16,70 |
| Szyld WC | 21,38 | 26,30 |

Bilbao - R

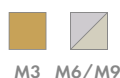

M3 M6/M9

Szyld 950

| | Netto | Brutto |
|-----------------|--------------|--------|
| Klamka dzielona | 35,20 | 43,30 |
| Szyld BB PZ | 13,58 | 16,70 |
| Szyld WC | 21,38 | 26,30 |

Biskopt - R



biały brąz

Szyld Biskopt-R

| | Netto | Brutto |
|-----------------|--------------|--------|
| Klamka dzielona | 12,36 | 15,20 |
| Szyld BB PZ | 3,90 | 4,80 |
| Szyld WC | 8,70 | 10,70 |

Casablanca - R

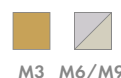

M3 M6/M9

Szyld 950

| | Netto | Brutto |
|-----------------|--------------|--------|
| Klamka dzielona | 34,23 | 42,10 |
| Szyld BB PZ | 13,58 | 16,70 |
| Szyld WC | 21,38 | 26,30 |

Econom - R



biały brąz

Szyld Econom-R

| | Netto | Brutto |
|-----------------|-------------|--------|
| Klamka dzielona | 9,59 | 11,80 |
| Szyld BB PZ | 2,93 | 3,60 |
| Szyld WC | 5,77 | 7,10 |

Capri - R

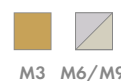
M3 M9

Szyld 980

| | Netto | Brutto |
|-----------------|--------------|--------|
| Klamka dzielona | 35,28 | 43,40 |
| Szyld BB PZ | 16,02 | 19,70 |
| Szyld WC | 25,61 | 31,50 |



Dekan - R

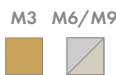
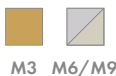

Szyld 950

| | Netto | Brutto |
|-----------------|-------|--------|
| Klamka dzielona | 35,45 | 43,60 |
| Szyld BB PZ | 13,58 | 16,70 |
| Szyld WC | 21,38 | 26,30 |

Elizabeth - R



Szyld 950

| | Netto | Brutto |
|-----------------|-------|--------|
| Klamka dzielona | 50,00 | 61,50 |
| Szyld BB PZ | 13,58 | 16,70 |
| Szyld WC | 21,38 | 26,30 |

Enigma - R

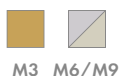

Szyld 980

| | Netto | Brutto |
|-----------------|-------|--------|
| Klamka dzielona | 37,15 | 45,70 |
| Szyld BB PZ | 16,02 | 19,70 |
| Szyld WC | 25,61 | 31,50 |

Ellegant - R



Szyld 950

| | Netto | Brutto |
|-----------------|-------|--------|
| Klamka dzielona | 73,82 | 90,80 |
| Szyld BB PZ | 13,58 | 16,70 |
| Szyld WC | 21,38 | 26,30 |

Fly - R eco

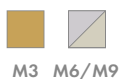

Szyld 950

| | Netto | Brutto |
|-----------------|-------|--------|
| Klamka dzielona | 32,44 | 39,90 |
| Szyld BB PZ | 13,58 | 16,70 |
| Szyld WC | 21,38 | 26,30 |

Fokus - R

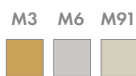
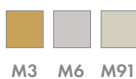

Szyld 950

| | Netto | Brutto |
|-----------------|-------|--------|
| Klamka dzielona | 36,75 | 45,20 |
| Szyld BB PZ | 13,58 | 16,70 |
| Szyld WC | 21,38 | 26,30 |

Galaxy - R



Szyld 950

| | Netto | Brutto |
|-----------------|-------|--------|
| Klamka dzielona | 33,25 | 40,90 |
| Szyld BB PZ | 13,58 | 16,70 |
| Szyld WC | 21,38 | 26,30 |



Ibis - R

M3 MAT



M3 MAT

Szyld 950

| | Netto | Brutto |
|-----------------|--------------|--------|
| Klamka dzielona | 31,50 | 38,80 |
| Szyld BB PZ | 13,57 | 16,70 |
| Szyld WC | 25,52 | 31,40 |

| | | |
|-----------------|--------------|-------|
| Klamka dzielona | 31,50 | 38,80 |
| Szyld BB PZ | 13,57 | 16,70 |
| Szyld WC | 25,52 | 31,40 |

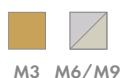
Insignia - R



M3 M6/M9

Szyld 950

| | Netto | Brutto |
|-----------------|--------------|--------|
| Klamka dzielona | 30,89 | 38,00 |
| Szyld BB PZ | 13,58 | 16,70 |
| Szyld WC | 21,38 | 26,30 |

| | | |
|-----------------|--------------|-------|
| Klamka dzielona | 30,89 | 38,00 |
| Szyld BB PZ | 13,58 | 16,70 |
| Szyld WC | 21,38 | 26,30 |

Jane - R

M6/M9

M6/M9

Szyld 950

| | Netto | Brutto |
|-----------------|--------------|--------|
| Klamka dzielona | 37,89 | 46,60 |
| Szyld BB PZ | 13,58 | 16,70 |
| Szyld WC | 21,38 | 26,30 |

| | | |
|-----------------|--------------|-------|
| Klamka dzielona | 37,89 | 46,60 |
| Szyld BB PZ | 13,58 | 16,70 |
| Szyld WC | 21,38 | 26,30 |

Jane - R AG1

M9

M9

Szyld Jane-R AG1

| | Netto | Brutto |
|-----------------|--------------|--------|
| Klamka dzielona | 36,75 | 45,20 |
| Szyld BB PZ | 10,65 | 13,10 |
| Szyld WC | 23,98 | 29,50 |

| | | |
|-----------------|--------------|-------|
| Klamka dzielona | 36,75 | 45,20 |
| Szyld BB PZ | 10,65 | 13,10 |
| Szyld WC | 23,98 | 29,50 |

Jaro - R

M6/M9

M6/M9

Szyld 950

| | Netto | Brutto |
|-----------------|--------------|--------|
| Klamka dzielona | 51,87 | 63,80 |
| Szyld BB PZ | 13,58 | 16,70 |
| Szyld WC | 21,38 | 26,30 |

| | | |
|-----------------|--------------|-------|
| Klamka dzielona | 51,87 | 63,80 |
| Szyld BB PZ | 13,58 | 16,70 |
| Szyld WC | 21,38 | 26,30 |

Jaro - R eco

M6/M9

M6/M9

Szyld 950

| | Netto | Brutto |
|-----------------|--------------|--------|
| Klamka dzielona | 34,31 | 42,20 |
| Szyld BB PZ | 13,58 | 16,70 |
| Szyld WC | 21,38 | 26,30 |

| | | |
|-----------------|--------------|-------|
| Klamka dzielona | 34,31 | 42,20 |
| Szyld BB PZ | 13,58 | 16,70 |
| Szyld WC | 21,38 | 26,30 |

Jola - R

M9

M9

Szyld 950

| | Netto | Brutto |
|-----------------|--------------|--------|
| Klamka dzielona | 22,93 | 28,20 |
| Szyld BB PZ | 13,58 | 16,70 |
| Szyld WC | 21,38 | 26,30 |

| | | |
|-----------------|--------------|-------|
| Klamka dzielona | 22,93 | 28,20 |
| Szyld BB PZ | 13,58 | 16,70 |
| Szyld WC | 21,38 | 26,30 |

Kyrk - R

M6/M9

M6/M9

Szyld 950

| | Netto | Brutto |
|-----------------|--------------|--------|
| Klamka dzielona | 19,43 | 23,90 |
| Szyld BB PZ | 13,58 | 16,70 |
| Szyld WC | 21,38 | 26,30 |

| | | |
|-----------------|--------------|-------|
| Klamka dzielona | 19,43 | 23,90 |
| Szyld BB PZ | 13,58 | 16,70 |
| Szyld WC | 21,38 | 26,30 |

Lavia - R

M6/M9

M6/M9

Szyld 950

| | Netto | Brutto |
|-----------------|--------------|--------|
| Klamka dzielona | 61,38 | 75,50 |
| Szyld BB PZ | 13,58 | 16,70 |
| Szyld WC | 21,38 | 26,30 |

| | | |
|-----------------|--------------|-------|
| Klamka dzielona | 61,38 | 75,50 |
| Szyld BB PZ | 13,58 | 16,70 |
| Szyld WC | 21,38 | 26,30 |



Ludwik - R



M6/White



Szyld 950

M6



| | Netto | Brutto |
|-----------------|--------------|--------|
| Klamka dzielona | 73,82 | 90,80 |
| Szyld BB PZ | 13,58 | 16,70 |
| Szyld WC | 21,38 | 26,30 |

Loft - R



M75 M95 czarny



M75 M95 czarny



Szyld 950

Netto Brutto

| | | |
|-----------------|--------------|-------|
| Klamka dzielona | 57,56 | 70,80 |
| Szyld BB PZ | 13,58 | 16,70 |
| Szyld WC | 21,38 | 26,30 |

Marion - R



DO WYCZEPANIA



M6/M9



M6/M9



Szyld 950

Netto Brutto

| | | |
|-----------------|--------------|-------|
| Klamka dzielona | 50,65 | 62,30 |
| Szyld BB PZ | 13,58 | 16,70 |
| Szyld WC | 21,38 | 26,30 |

Monaco - R



DO WYCZEPANIA



M3 M9



M3 m7



Szyld 950

Netto Brutto

| | | |
|-----------------|--------------|-------|
| Klamka dzielona | 29,11 | 35,80 |
| Szyld BB PZ | 13,58 | 16,70 |
| Szyld WC | 21,38 | 26,30 |



Nemo - R



Szyld 950



| | Netto | Brutto |
|-----------------|--------------|--------|
| Klamka dzielona | 31,71 | 39,00 |
| Szyld BB PZ | 13,58 | 16,70 |
| Szyld WC | 21,38 | 26,30 |

Malta - R



Szyld 950

| | Netto | Brutto |
|-----------------|--------------|--------|
| Klamka dzielona | 61,38 | 75,50 |
| Szyld BB PZ | 13,58 | 16,70 |
| Szyld WC | 21,38 | 26,30 |

Nova - R

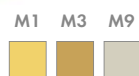

Szyld 950

| | Netto | Brutto |
|-----------------|--------------|--------|
| Klamka dzielona | 34,39 | 42,30 |
| Szyld BB PZ | 13,58 | 16,70 |
| Szyld WC | 21,38 | 26,30 |

Omega - R



Szyld 950

| | Netto | Brutto |
|-----------------|--------------|--------|
| Klamka dzielona | 42,93 | 52,80 |
| Szyld BB PZ | 13,58 | 16,70 |
| Szyld WC | 21,38 | 26,30 |



Onyks - R



Szyld 950



| | Netto | Brutto |
|-----------------|--------------|--------|
| Klamka dzielona | 73,82 | 90,80 |
| Szyld BB PZ | 13,58 | 16,70 |
| Szyld WC | 21,38 | 26,30 |

Otto - R



Szyld 950

| | Netto | Brutto |
|-----------------|--------------|--------|
| Klamka dzielona | 26,02 | 32,00 |
| Szyld BB PZ | 13,58 | 16,70 |
| Szyld WC | 21,38 | 26,30 |

Petra - R

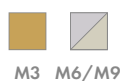

Szyld 950

| | Netto | Brutto |
|-----------------|--------------|--------|
| Klamka dzielona | 33,33 | 41,00 |
| Szyld BB PZ | 13,58 | 16,70 |
| Szyld WC | 21,38 | 26,30 |

Pro - R



Szyld Pro-R

| | Netto | Brutto |
|-----------------|--------------|--------|
| Klamka dzielona | 17,64 | 21,70 |
| Szyld BB PZ | 6,67 | 8,20 |
| Szyld WC | 10,57 | 13,00 |



Presto - R



domino

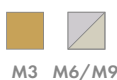

M3 M6/M9

Szyld 950

Netto Brutto

| | | |
|-----------------|--------------|-------|
| Klamka dzielona | 30,73 | 37,80 |
| Szyld BB PZ | 13,58 | 16,70 |
| Szyld WC | 21,38 | 26,30 |

Rio - R



domino

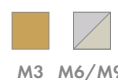

M3 M6/M9

Szyld 980



M3 M9

Netto Brutto

| | | |
|-----------------|--------------|-------|
| Klamka dzielona | 30,65 | 37,70 |
| Szyld BB PZ | 16,02 | 19,70 |
| Szyld WC | 25,61 | 31,50 |

Romana - R

domino



M3 M6/M9 czarny



M3 M6/M9 czarny

Szyld 950

Netto Brutto

| | | |
|-----------------|--------------|-------|
| Klamka dzielona | 30,65 | 37,70 |
| Szyld BB PZ | 13,58 | 16,70 |
| Szyld WC | 21,38 | 26,30 |

Sharon - R eco

domino



M6/M9



M6/M9

Szyld 950

Netto Brutto

| | | |
|-----------------|--------------|-------|
| Klamka dzielona | 32,44 | 39,90 |
| Szyld BB PZ | 13,58 | 16,70 |
| Szyld WC | 21,38 | 26,30 |

Snap - R

domino



M6/White



M6

Szyld 980

Netto Brutto

| | | |
|-----------------|--------------|-------|
| Klamka dzielona | 73,82 | 90,80 |
| Szyld BB PZ | 16,02 | 19,70 |
| Szyld WC | 25,61 | 31,50 |

Tiger - R

domino



M9



M9

Szyld Tiger-R

Netto Brutto

| | | |
|-----------------|--------------|-------|
| Klamka dzielona | 10,57 | 13,00 |
| Szyld BB PZ | 3,74 | 4,60 |
| Szyld WC | 7,40 | 9,10 |

Time - R

domino



M6 M9



M6 M9

Szyld 950

Netto Brutto

| | | |
|-----------------|--------------|-------|
| Klamka dzielona | 66,67 | 82,00 |
| Szyld BB PZ | 13,58 | 16,70 |
| Szyld WC | 21,38 | 26,30 |

Wing - R



domino



M2 M3



M2 M3

Szyld 950

Netto Brutto

| | | |
|-----------------|--------------|-------|
| Klamka dzielona | 22,93 | 28,20 |
| Szyld BB PZ | 13,58 | 16,70 |
| Szyld WC | 21,38 | 26,30 |



WYMIENIAMY
INSPIRUJĄCE
DOŚWIADCZENIA.



4

KLAMKI NA DZIELONYM
SZYLDZIE OKRĄGŁYM

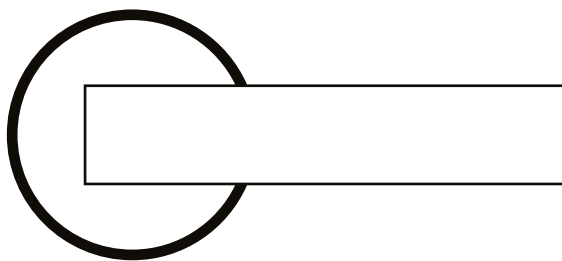

PREMIUM

PREMIUM



KLAMKI WEWNĘTRZNE | KLAMKI NA DZIELONYM SZYLDZIE OKRĄGŁYM

Apollo - R



M1 M3

Szyld 0003/6065



| | Netto | Brutto |
|-----------------|--------|--------|
| Klamka dzielona | 145,69 | 179,20 |
| Szyld BB PZ | 43,01 | 52,90 |
| Szyld WC | 76,34 | 93,90 |

Aurea - R



M4 M6

Szyld 6060



| | Netto | Brutto |
|-----------------|-------|--------|
| Klamka dzielona | 75,37 | 92,70 |
| Szyld BB PZ | 18,70 | 23,00 |
| Szyld WC | 43,74 | 53,80 |

B a l i - R



M75



M75

Szyld 6060



| | Netto | Brutto |
|-----------------|--------|--------|
| Klamka dzielona | 178,29 | 219,30 |
| Szyld BB PZ | 18,70 | 23,00 |
| Szyld WC | 43,74 | 53,80 |

D e l p h i - R



M6/M50 M6/M9



M6/M50 M6/M9

Szyld 555



| | Netto | Brutto |
|-----------------|--------|--------|
| Klamka dzielona | 187,07 | 230,10 |
| Szyld BB PZ | 47,32 | 58,20 |
| Szyld WC | 102,76 | 126,40 |

Delux - R



M9



M9

Szyld Oro-R



| | Netto | Brutto |
|-----------------|-------|--------|
| Klamka dzielona | 92,20 | 113,40 |
| Szyld BB PZ | 21,06 | 25,90 |
| Szyld WC | 26,75 | 32,90 |

Duncan - R



M9



| | Netto | Brutto |
|----------------|--------|--------|
| Klamka BB PZ | 198,46 | 244,10 |
| Klamka WC | 216,91 | 266,80 |

Frost-R



M6



| | Netto | Brutto |
|----------------|--------|--------|
| Klamka BB PZ | 198,46 | 244,10 |
| Klamka WC | 216,91 | 266,80 |

Gran Pix-R



M4 M6



| | Netto | Brutto |
|----------------|--------|--------|
| Klamka BB PZ | 230,65 | 283,70 |
| Klamka WC | 340,65 | 419,00 |

Helena - R



M1/M2 M7/M9



Szyld 555

M1/M2 M7/M9



| | Netto | Brutto |
|-----------------|--------|--------|
| Klamka dzielona | 299,51 | 368,40 |
| Szyld BB PZ | 47,32 | 58,20 |
| Szyld WC | 102,76 | 126,40 |

Hera - R - R S



M1/M2 M7/M9



Szyld 555

M1/M2 M7/M9



| | Netto | Brutto |
|-----------------|--------|--------|
| Klamka dzielona | 268,21 | 329,90 |
| Szyld BB PZ | 47,32 | 58,20 |
| Szyld WC | 102,76 | 126,40 |

I k k o - R



M6/Black



| | Netto | Brutto |
|----------------|--------|--------|
| Klamka BB PZ | 198,46 | 244,10 |
| Klamka WC | 216,91 | 266,80 |

I r i s - R



M9



Szyld 555

M9



| | Netto | Brutto |
|-----------------|--------|--------|
| Klamka dzielona | 247,64 | 304,60 |
| Szyld BB PZ | 47,32 | 58,20 |
| Szyld WC | 102,76 | 126,40 |

Klotho - R



M1 M9

Szyld 555



| | Netto | Brutto |
|-----------------|--------|--------|
| Klamka dzielona | 225,28 | 277,10 |
| Szyld BB PZ | 47,32 | 58,20 |
| Szyld WC | 102,76 | 126,40 |

Lavinia - R



DO
WYCZERPANIA



M1/M2 M6/M9

Szyld 555



| | Netto | Brutto |
|-----------------|--------|--------|
| Klamka dzielona | 126,02 | 155,00 |
| Szyld BB PZ | 47,32 | 58,20 |
| Szyld WC | 102,76 | 126,40 |

Lavinia-R Cristal



DO
WYCZERPANIA



M9



Szyld 555

M9

| | Netto | Brutto |
|-----------------|--------|--------|
| Klamka dzielona | 430,81 | 529,90 |
| Szyld BB PZ | 47,32 | 58,20 |
| Szyld WC | 102,76 | 126,40 |

Lamia - R



M1/M2



Szyld 555

M1/M2



| | Netto | Brutto |
|-----------------|--------|--------|
| Klamka dzielona | 182,44 | 224,40 |
| Szyld BB PZ | 47,32 | 58,20 |
| Szyld WC | 102,76 | 126,40 |

Leonardo - R



M4 M6



| | Netto | Brutto |
|----------------|--------|--------|
| Klamka BB PZ | 283,74 | 349,00 |
| Klamka WC | 300,00 | 369,00 |

L i v a - R



| | Netto | Brutto |
|----------------|--------|--------|
| Klamka BB PZ | 198,46 | 244,10 |
| Klamka WC | 216,91 | 266,80 |

L u x o r - R



| | Netto | Brutto |
|----------------|--------|--------|
| Klamka BB PZ | 372,20 | 457,80 |
| Klamka WC | 390,81 | 480,70 |

Matteo - R



M1/M2 M7/M9



Szyld 555

M1/M2 M7/M9



| | Netto | Brutto |
|-----------------|--------|--------|
| Klamka dzielona | 126,91 | 156,10 |
| Szyld BB PZ | 47,32 | 58,20 |
| Szyld WC | 102,76 | 126,40 |

Morfeo - R



M6



| | Netto | Brutto |
|----------------|--------|--------|
| Klamka BB PZ | 331,71 | 408,00 |
| Klamka WC | 408,62 | 502,60 |

Pallas - R



Szyld 555

M1/M2 M6/M50 M6/M9



| | Netto | Brutto |
|-----------------|---------------|--------|
| Klamka dzielona | 241,38 | 296,90 |
| Szyld BB PZ | 47,32 | 58,20 |
| Szyld WC | 102,76 | 126,40 |

Pira - R



| | Netto | Brutto |
|----------------|---------------|--------|
| Klamka BB PZ | 198,46 | 244,10 |
| Klamka WC | 216,91 | 266,80 |

Polaris - R



M6/Black M6/Red M6/White



| | Netto | Brutto |
|----------------|--------|--------|
| Klamka BB PZ | 198,46 | 244,10 |
| Klamka WC | 216,91 | 266,80 |

Roma - R



M1/M2 M6/M18 M7/M9



M1/M2 M6/M18 M7/M9



Szyld 555

| | Netto | Brutto |
|-----------------|--------|--------|
| Klamka dzielona | 197,56 | 243,00 |
| Szyld BB PZ | 47,32 | 58,20 |
| Szyld WC | 102,76 | 126,40 |

Skin - R



M3 MAT M9

Szyld Oro-R



| | Netto | Brutto |
|-----------------|-------|--------|
| Klamka dzielona | 92,20 | 113,40 |
| Szyld BB PZ | 21,06 | 25,90 |
| Szyld WC | 26,75 | 32,90 |

Snake - R



M6

Szyld Oro-R



| | Netto | Brutto |
|-----------------|-------|--------|
| Klamka dzielona | 92,20 | 113,40 |
| Szyld BB PZ | 21,06 | 25,90 |
| Szyld WC | 26,75 | 32,90 |

Tora-R



| | Netto | Brutto |
|----------------|--------|--------|
| Klamka BB PZ | 198,46 | 244,10 |
| Klamka WC | 216,91 | 266,80 |

Toro-R



M3 MAT M6

Szyld Oro-R

| | Netto | Brutto |
|-----------------|-------|--------|
| Klamka dzielona | 92,20 | 113,40 |
| Szyld BB PZ | 21,06 | 25,90 |
| Szyld WC | 26,75 | 32,90 |

Tuluz a - R

BINALIA



M1/M2 M3 M75



Szyld 6060

M1 M3 M75



| | Netto | Brutto |
|-----------------|-------|--------|
| Klamka dzielona | 74,55 | 91,70 |
| Szyld BB PZ | 18,70 | 23,00 |
| Szyld WC | 43,74 | 53,80 |

Zita - R

Ghidini
group



M1/M2 M6/M18 M7/M9



Szyld 555

M1/M2 M6/M18 M7/M9



| | Netto | Brutto |
|-----------------|--------|--------|
| Klamka dzielona | 238,70 | 293,60 |
| Szyld BB PZ | 47,32 | 58,20 |
| Szyld WC | 102,76 | 126,40 |

Valentina - R

 BINALIA



M75

Szyld 6060

| | Netto | Brutto |
|-----------------|--------|--------|
| Klamka dzielona | 113,50 | 139,60 |
| Szyld BB PZ | 18,70 | 23,00 |
| Szyld WC | 43,74 | 53,80 |

Venus - R

 BINALIA



M1 M75

Szyld 6060

| | Netto | Brutto |
|-----------------|-------|--------|
| Klamka dzielona | 65,20 | 80,20 |
| Szyld BB PZ | 18,70 | 23,00 |
| Szyld WC | 43,74 | 53,80 |



KLAMKI
PREMIUM



SZANOWNI PAŃSTWO,

MAMY PRZYJEMNOŚĆ ZAPREZENTOWAĆ PAŃSTWU
NASZĄ NAJNOWSZĄ KOLEKCJĘ KLAMEK PREMIUM –
DOMINO DESIGN.

Otwierając kolejne strony katalogu poznacie Państwo produkty nowoczesne i niebanalne w swoim designie – klamki, które nie są tylko niezbędnym wyposażeniem domu, ale stają się ważną dekoracją Państwa wnętrza.

Tworząc produkty zawarte w tym katalogu, zastosowaliśmy materiały najwyższej jakości i zatroszczyliśmy się o każdy, nawet najdrobniejszy, detal, co będziecie mogli Państwo odczuć korzystając z naszych klamek każdego dnia.

Nasze wieloletnie doświadczenie i pasja do tego co robimy są gwarancją, że produkt, który Państwo zakupicie, będzie służył przez wiele, wiele lat i wytrzyma mnóstwo naciśnień oraz szarpnięć.

Z poważaniem,

Zofia i Eugeniusz Świszcz
DOMINO Polska



B u z z - Q R



M91

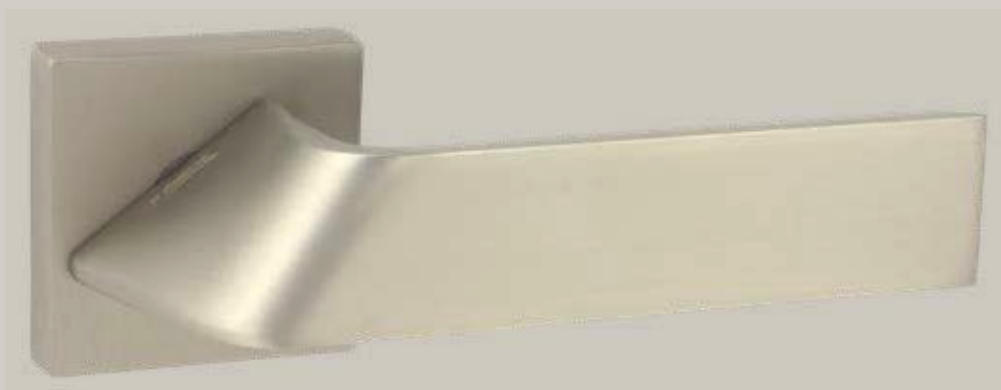

| | Netto | Brutto |
|----------------|--------|--------|
| Klamka BB PZ | 178,05 | 219,00 |
| Klamka WC | 186,18 | 229,00 |

Nowy profil nowoczesności.

Piękny profil klamki połączony z prostotą i nowoczesnością tworzą niebanalne wykończenie aranżacyjne wnętrza, idącego z duchem czasu. Ciekawie zagięta rękojeść klamki sprawia, iż taki drobny akcent nadaje jej niebanalnego wyrazu, który wiąże się także z wygodą codziennego użytkowania.



Like - QR



M91/Wood



| | Netto | Brutto |
|----------------|--------|--------|
| Klamka BB PZ | 178,05 | 219,00 |
| Klamka WC | 186,18 | 229,00 |

Szlachetność drewna w nowoczesnym wydaniu.

Drewno już dawno zerwało ze swoim tradycyjnym wydaniem i jest obecnie mocnym akcentem nowoczesnych wnętrz. Prezentowana klamka to najlepszy tego przykład- prosta, oryginalna, a przy tym z nutą subtelności za sprawą cieplej barwy drewna. Z pewnością podkreśli wyrefinowany gust miłośnika szlachetności w nowoczesnym wydaniu.



Wolf-QR



M8/Black

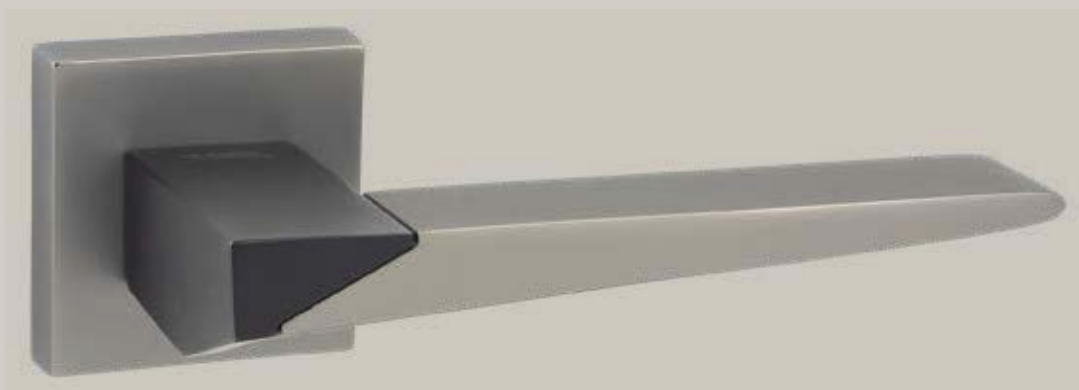

| | Netto | Brutto |
|----------------|--------|--------|
| Klamka BB PZ | 178,05 | 219,00 |
| Klamka WC | 186,18 | 229,00 |

Ponadczasowa siła szczegółu.

Dodatki i wykończenie wnętrza czasem najmocniej akcentuje jego charakter. Ta klamka to propozycja dla miłośników dobrego wzornictwa i fanów nowoczesności. Połączenie dwóch kolorów sprawia, że klamka jest ciekawa i przyciąga wzrok podkreślając dobry gust domowników.



Xo - QR



M91



| | Netto | Brutto |
|----------------|--------|--------|
| Klamka BB PZ | 178,05 | 219,00 |
| Klamka WC | 186,18 | 229,00 |

Design wpisany w geometrię.

Geometryczne formy są od kilku lat najmodniejszymi kształtami w aranżacji wnętrz i pozostaną takie na długo, ponieważ są ponadczasowe. Prosta klamka, która jest jednocześnie bardzo ciekawa, dzięki lekkiemu wygięciu, co dodatkowo wpływa na komfort jej użytkowania.



Zone - R



| | Netto | Brutto |
|----------------|--------|--------|
| Klamka BB PZ | 178,05 | 219,00 |
| Klamka WC | 186,18 | 229,00 |

Zachwył przez kolor i kształt.

Ta klamka sprawia, że każdy zawiesz na niej nie tylko dłoń, ale i oko. Idealna do jasnych, nowoczesnych apartamentów, którym dodatkowo nadaje lekkości. Połączenie bieli i niklu sprawia, iż jest akcentem niebanalnym i świadczy o rozeznaniu domowników w najnowszych trendach.



Luna-R



| | Netto | Brutto |
|----------------|--------|--------|
| Klamka BB PZ | 178,05 | 219,00 |
| Klamka WC | 186,18 | 229,00 |

Najwyższy poziom designu.

Niebanalna i bardzo designerska klamka z najnowszej kolekcji Premium Design to propozycja dla wielbicieli nowoczesnych i odważnych rozwiązań. Opływowa forma, ponadczasowy, lekki kolor i subtelne zdobienie tworzą spójną całość uzupełniającą modny charakter wnętrza.



Moon-R



M8/Black



| | Netto | Brutto |
|----------------|--------|--------|
| Klamka BB PZ | 178,05 | 219,00 |
| Klamka WC | 186,18 | 229,00 |

Prosta forma doskonałości.

Yin i Yang w nowoczesnym wydaniu? Różne, ale uzupełniające się dwa kolory nadają tej klamce niepowtarzalnego charakteru, przez co będzie ona tworzyć mocny akcent podkreślający ducha wnętrza. Idealna propozycja dla miłośników prostej formy, która zarazem nie jest nudna.



Roll-R



M91/Wood



| | Netto | Brutto |
|----------------|--------|--------|
| Klamka BB PZ | 178,05 | 219,00 |
| Klamka WC | 186,18 | 229,00 |

Nowoczesna oryginalność.

Klamka, która łączy w sobie wszystkie modne obecnie trendy- drewno, opływowe kształty i wysublimowany design. To propozycja dla każdego, kto stawia na oryginalność i ponadczasowe rozwiązania. Idealna do wnętrza minimalistycznego, w którym postawiono na drewniane elementy dekoracyjne.



WSPÓLNIE
WYBIERAMY
NAJLEPSZE
ROZWIĄZANIA.



5

KLAMKI NA
DŁUGIM SZYLDZIE

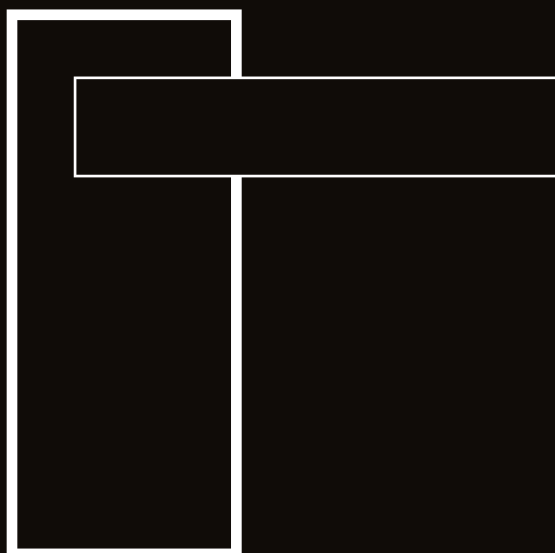

Afrodyta



| | Netto | Brutto |
|----------------------|-------|--------|
| Klamka BB B/O PZ | 66,02 | 81,20 |
| Klamka WC | 69,11 | 85,00 |

Alma eco



| | Netto | Brutto |
|------------------------|-------|--------|
| Klamka BB B/O PZ | 34,23 | 42,10 |
| Klamka WC lewa prawa | 37,56 | 46,20 |

Ballen



| | Netto | Brutto |
|----------------------|-------|--------|
| Klamka BB B/O PZ | 30,08 | 37,00 |
| Klamka WC | 35,04 | 43,10 |

Bilbao



| | Netto | Brutto |
|----------------------|-------|--------|
| Klamka BB B/O PZ | 35,20 | 43,30 |
| Klamka WC | 38,29 | 47,10 |

Biskopt



| | Netto | Brutto |
|----------------|-------|--------|
| Klamka BB PZ | 19,11 | 23,50 |
| Klamka WC | 24,80 | 30,50 |

Capri

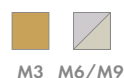

| | Netto | Brutto |
|----------------------|-------|--------|
| Klamka BB B/O PZ | 35,28 | 43,40 |
| Klamka WC | 38,94 | 47,90 |

Casablanca



| | Netto | Brutto |
|------------------------|-------|--------|
| Klamka BB B/O PZ | 37,56 | 46,20 |
| Klamka WC lewa prawa | 41,38 | 50,90 |

Dekan

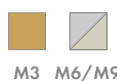

| | Netto | Brutto |
|----------------------|-------|--------|
| Klamka BB B/O PZ | 35,45 | 43,60 |
| Klamka WC | 39,02 | 48,00 |

Econom



| | Netto | Brutto |
|----------------------|-------|--------|
| Klamka BB B/O PZ | 13,82 | 17,00 |
| Klamka WC | 15,69 | 19,30 |



Elizabeth





M6/M9

| | Netto | Brutto |
|------------------------|--------------|--------|
| Klamka BB B/O PZ | 39,43 | 48,50 |
| Klamka WC lewa prawa | 42,93 | 52,80 |

Enigma



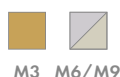

M3 M6/M9

| | Netto | Brutto |
|----------------------|--------------|--------|
| Klamka BB B/O PZ | 37,15 | 45,70 |
| Klamka WC | 40,89 | 50,30 |

Fero





M91

| | Netto | Brutto |
|----------------------|--------------|--------|
| Klamka BB B/O PZ | 29,11 | 35,80 |
| Klamka WC | 33,66 | 41,40 |

Fly eco





M3 M9

| | Netto | Brutto |
|------------------------|--------------|--------|
| Klamka BB B/O PZ | 32,44 | 39,90 |
| Klamka WC lewa prawa | 37,64 | 46,30 |

Fokus



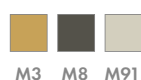

M3 M8 M91

| | Netto | Brutto |
|----------------------|--------------|--------|
| Klamka BB B/O PZ | 32,20 | 39,60 |
| Klamka WC | 35,20 | 43,30 |

Ibis





M3 MAT M9

| | Netto | Brutto |
|----------------------|--------------|--------|
| Klamka BB B/O PZ | 37,64 | 46,30 |
| Klamka WC | 41,38 | 50,90 |

Insignia



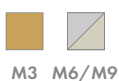

M3 M6/M9

| | Netto | Brutto |
|----------------------|--------------|--------|
| Klamka BB B/O PZ | 35,93 | 44,20 |
| Klamka WC | 39,84 | 49,00 |

Jane



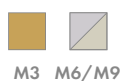

M3 M6/M9

| | Netto | Brutto |
|------------------------|--------------|--------|
| Klamka BB B/O | 61,38 | 75,50 |
| Klamka WC lewa prawa | 66,02 | 81,20 |

Jaro





M6/M9

| | Netto | Brutto |
|------------------------|--------------|--------|
| Klamka BB B/O PZ | 65,28 | 80,30 |
| Klamka WC lewa prawa | 69,11 | 85,00 |



Jaro eco





M6/M9

| | Netto | Brutto |
|----------------------|--------------|--------|
| Klamka BB B/O PZ | 36,10 | 44,40 |
| Klamka WC | 41,30 | 50,80 |

Jola





M3 M9

| | Netto | Brutto |
|----------------------|--------------|--------|
| Klamka BB B/O PZ | 29,11 | 35,80 |
| Klamka WC | 33,66 | 41,40 |

Loft





M75 M95 czarny

| | Netto | Brutto |
|----------------------|--------------|--------|
| Klamka BB B/O PZ | 70,24 | 86,40 |
| Klamka WC | 73,82 | 90,80 |

Malta





M3 MAT

| | Netto | Brutto |
|------------------------|--------------|--------|
| Klamka BB B/O PZ | 72,60 | 89,30 |
| Klamka WC lewa prawa | 76,75 | 94,40 |

Monaco





M3

| | Netto | Brutto |
|----------------------|--------------|--------|
| Klamka BB B/O PZ | 29,11 | 35,80 |
| Klamka WC | 32,20 | 39,60 |

Nemo





M3 M9

| | Netto | Brutto |
|----------------------|--------------|--------|
| Klamka BB B/O PZ | 31,54 | 38,80 |
| Klamka WC | 35,20 | 43,30 |

Nova





M1 M3 M9

| | Netto | Brutto |
|----------------------|--------------|--------|
| Klamka BB B/O PZ | 32,52 | 40,00 |
| Klamka WC | 36,75 | 45,20 |

Omega





M9

| | Netto | Brutto |
|----------------------|--------------|--------|
| Klamka BB B/O PZ | 38,13 | 46,90 |
| Klamka WC | 44,39 | 54,60 |

Oslo





M3 M9

| | Netto | Brutto |
|------------------------|--------------|--------|
| Klamka BB B/O PZ | 39,43 | 48,50 |
| Klamka WC lewa prawa | 42,93 | 52,80 |



Presto



M3 M6/M9



| | Netto | Brutto |
|------------------------|--------------|--------|
| Klamka BB B/O PZ | 30,65 | 37,70 |
| Klamka WC lewa prawa | 33,66 | 41,40 |

Real



M6/M9



| | Netto | Brutto |
|----------------------|--------------|--------|
| Klamka BB B/O PZ | 40,81 | 50,20 |
| Klamka WC | 47,89 | 58,90 |

Otto



M3 MAT



| | Netto | Brutto |
|------------------------|--------------|--------|
| Klamka BB B/O PZ | 26,02 | 32,00 |
| Klamka WC lewa prawa | 29,11 | 35,80 |

Petra



M3 M9



| | Netto | Brutto |
|----------------------|--------------|--------|
| Klamka BB B/O PZ | 40,33 | 49,60 |
| Klamka WC | 44,47 | 54,70 |

Pro



M3 M9



| | Netto | Brutto |
|----------------------|--------------|--------|
| Klamka BB B/O PZ | 22,11 | 27,20 |
| Klamka WC | 26,83 | 33,00 |



Rio



M3 M6/M9

| | Netto | Brutto |
|----------------------|--------------|--------|
| Klamka BB B/O PZ | 30,65 | 37,70 |
| Klamka WC | 35,20 | 43,30 |

Romana



M3 M9 czarny

| | Netto | Brutto |
|----------------------|--------------|--------|
| Klamka BB B/O PZ | 30,65 | 37,70 |
| Klamka WC | 35,20 | 43,30 |

Sharon eco



M6/M9

| | Netto | Brutto |
|----------------------|--------------|--------|
| Klamka BB B/O PZ | 41,54 | 51,10 |
| Klamka WC | 48,78 | 60,00 |

Tiger



M9

| | Netto | Brutto |
|----------------------|--------------|--------|
| Klamka BB B/O PZ | 16,18 | 19,90 |
| Klamka WC | 20,00 | 24,60 |

Tre



M3 M9

| | Netto | Brutto |
|----------------------|--------------|--------|
| Klamka BB B/O PZ | 29,11 | 35,80 |
| Klamka WC | 32,20 | 39,60 |



ODPOCZYWAMY
PO SWOJEMU
ULUBIONEMU.



6

KLAMKI **NA**
DŁUGIM SZYLDZIE

PREMIUM

PREMIUM

KLAMKI WEWNĘTRZNE | KLAMKI NA DŁUGIM SZYLDZIE



Apollo



| | Netto | Brutto |
|----------------------|--------|--------|
| Klamka BB B/O PZ | 145,69 | 179,20 |
| Klamka WC | 178,78 | 219,90 |

Atene



| | Netto | Brutto |
|----------------|--------|--------|
| Klamka BB PZ | 300,00 | 369,00 |
| Klamka WC | 316,26 | 389,00 |



Luxor

 BINALIA



M3



| | Netto | Brutto |
|----------------------|--------|--------|
| Klamka BB B/O PZ | 243,09 | 299,00 |
| Klamka WC | 261,71 | 321,90 |

Bali

 BINALIA



M75



| | Netto | Brutto |
|----------------------|--------|--------|
| Klamka BB B/O PZ | 186,18 | 229,00 |
| Klamka WC | 198,46 | 244,10 |

Valentina

 BINALIA



M75



| | Netto | Brutto |
|----------------------|--------|--------|
| Klamka BB B/O PZ | 128,70 | 158,30 |
| Klamka WC | 138,29 | 170,10 |



Tuluza

 BINALIA

M1/M2 M3 M75



| | Netto | Brutto |
|----------------------|--------|--------|
| Klamka BB B/O PZ | 92,93 | 114,30 |
| Klamka WC | 117,97 | 145,10 |

Venus

 BINALIA

M1 M75



| | Netto | Brutto |
|----------------------|--------|--------|
| Klamka BB B/O PZ | 89,35 | 109,90 |
| Klamka WC | 112,60 | 138,50 |



WSPÓLNE
POMYSŁY
NIE ZNAJĄ
GRANIC.



KLAMKI
ZE STALI NIERDZEWNEJ



KLAMKI WEWNĘTRZNE | KLAMKI ZE STALI NIERDZEWNEJ

Agnessa - QR

domino®



INX

Szyld EF SN04-QR

Netto Brutto

| | | |
|-----------------|-------|-------|
| Klamka dzielona | 45,37 | 55,80 |
| Szyld BB PZ | 12,93 | 15,90 |
| Szyld WC | 24,15 | 29,70 |

Grisza - QR

domino®



INX

Szyld EF SN04-QR

Netto Brutto

| | | |
|-----------------|-------|-------|
| Klamka dzielona | 45,37 | 55,80 |
| Szyld BB PZ | 12,93 | 15,90 |
| Szyld WC | 24,15 | 29,70 |

Jane - QR

domino®



INX

Szyld EF SN04-QR

Netto Brutto

| | | |
|-----------------|-------|-------|
| Klamka dzielona | 45,37 | 55,80 |
| Szyld BB PZ | 12,93 | 15,90 |
| Szyld WC | 24,15 | 29,70 |

Liu - R

domino®



INX

Szyld EF Lui-R

Netto Brutto

| | | |
|-----------------|-------|-------|
| Klamka dzielona | 26,75 | 32,90 |
| Szyld BB PZ | 9,67 | 11,90 |
| Szyld WC | 20,24 | 24,90 |

Luka - QR

domino®



INX

Szyld EF SN04-QR

Netto Brutto

| | | |
|-----------------|-------|-------|
| Klamka dzielona | 46,75 | 57,50 |
| Szyld BB PZ | 12,93 | 15,90 |
| Szyld WC | 24,15 | 29,70 |

Padwa - R

domino®



INX/INX POLER

Szyld EF Lui-R

Netto Brutto

| | | |
|-----------------|-------|-------|
| Klamka dzielona | 54,47 | 67,00 |
| Szyld BB PZ | 9,67 | 11,90 |
| Szyld WC | 20,24 | 24,90 |



Prado - R



Szyld EF Lui-R



| | Netto | Brutto |
|-----------------|-------|--------|
| Klamka dzielona | 26,75 | 32,90 |
| Szyld BB PZ | 9,67 | 11,90 |
| Szyld WC | 20,24 | 24,90 |

domino®



Romana - QR



Szyld EF SN04-QR



| | Netto | Brutto |
|-----------------|-------|--------|
| Klamka dzielona | 55,37 | 68,10 |
| Szyld BB PZ | 12,93 | 15,90 |
| Szyld WC | 24,15 | 29,70 |

domino®



Romana - R



Szyld EF Lui-R



| | Netto | Brutto |
|-----------------|-------|--------|
| Klamka dzielona | 48,70 | 59,90 |
| Szyld BB PZ | 9,67 | 11,90 |
| Szyld WC | 20,24 | 24,90 |

domino®



Siena - R



Szyld EF Lui-R



| | Netto | Brutto |
|-----------------|-------|--------|
| Klamka dzielona | 54,47 | 67,00 |
| Szyld BB PZ | 9,67 | 11,90 |
| Szyld WC | 20,24 | 24,90 |

domino®



Sigma - QR



Szyld EF SN04-QR



| | Netto | Brutto |
|-----------------|-------|--------|
| Klamka dzielona | 36,26 | 44,60 |
| Szyld BB PZ | 12,93 | 15,90 |
| Szyld WC | 24,15 | 29,70 |

domino®



Sigma - R



Szyld EF Lui-R



| | Netto | Brutto |
|-----------------|-------|--------|
| Klamka dzielona | 26,75 | 32,90 |
| Szyld BB PZ | 9,67 | 11,90 |
| Szyld WC | 20,24 | 24,90 |

domino®



Sigma - R Owal



Szyld EF Owal



| | Netto | Brutto |
|-----------------|-------|--------|
| Klamka dzielona | 29,92 | 36,80 |
| Szyld PZ | 21,87 | 26,90 |

domino®



Uno

domino®

 INX

| | Netto | Brutto |
|----------------------|-------|--------|
| Klamka BB B/O PZ | 56,26 | 69,20 |
| Klamka WC | 64,96 | 79,90 |

| | | |
|----------------------|-------|-------|
| Klamka BB B/O PZ | 56,26 | 69,20 |
| Klamka WC | 64,96 | 79,90 |

Uno - R

domino®

 INX

Szyld EF Lui-R



| | Netto | Brutto |
|-----------------|-------|--------|
| Klamka dzielona | 26,75 | 32,90 |
| Szyld BB PZ | 9,67 | 11,90 |
| Szyld WC | 20,24 | 24,90 |

| | | |
|-----------------|-------|-------|
| Klamka dzielona | 26,75 | 32,90 |
| Szyld BB PZ | 9,67 | 11,90 |
| Szyld WC | 20,24 | 24,90 |

Uno 170

domino®

 INX

| | Netto | Brutto |
|-----------|-------|--------|
| Klamka PZ | 56,83 | 69,90 |

| | | |
|-----------|-------|-------|
| Klamka PZ | 56,83 | 69,90 |
|-----------|-------|-------|

Uno 170 Gałka

domino®

 INX

| | Netto | Brutto |
|-----------------------|-------|--------|
| Gałka stała (kpl.) PZ | 66,42 | 81,70 |

| | | |
|-----------------------|-------|-------|
| Gałka stała (kpl.) PZ | 66,42 | 81,70 |
|-----------------------|-------|-------|

Uno Gałka

domino®

 INX

| | Netto | Brutto |
|-----------------------|-------|--------|
| Gałka stała (kpl.) PZ | 66,42 | 81,70 |

| | | |
|-----------------------|-------|-------|
| Gałka stała (kpl.) PZ | 66,42 | 81,70 |
|-----------------------|-------|-------|

Uno - R Owal

domino®

 INX

Szyld EF Owal



| | Netto | Brutto |
|-----------------|-------|--------|
| Klamka dzielona | 29,92 | 36,80 |
| Szyld PZ | 21,87 | 26,90 |

| | | |
|-----------------|-------|-------|
| Klamka dzielona | 29,92 | 36,80 |
| Szyld PZ | 21,87 | 26,90 |

Uno 170 K+G

domino®

 INX

| | Netto | Brutto |
|------------------------|-------|--------|
| Klamka PZ lewa prawa | 59,67 | 73,40 |

| | | |
|------------------------|-------|-------|
| Klamka PZ lewa prawa | 59,67 | 73,40 |
|------------------------|-------|-------|

Uno K+G

domino®

 INX

| | Netto | Brutto |
|------------------------|-------|--------|
| Klamka PZ lewa prawa | 61,38 | 75,50 |

| | | |
|------------------------|-------|-------|
| Klamka PZ lewa prawa | 61,38 | 75,50 |
|------------------------|-------|-------|



DRZWI
OTWARTE SĄ
NA
EKSPERYMENTY.



8

KLAMKI NA DZIELONYM
SZYLDZIE SLIM

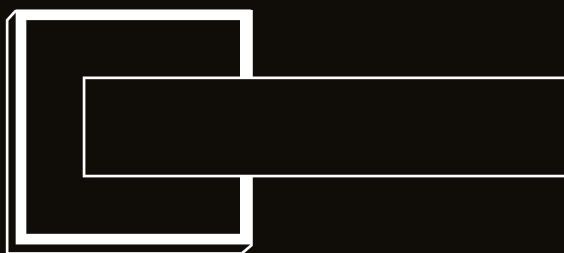

Jane - QR

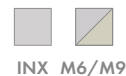

Szyld Slim-QR



| | | Netto | Brutto |
|-----------------|-------|---------------|--------|
| Klamka dzielona | INX | 84,23 | 103,60 |
| | M6/M9 | 100,89 | 124,10 |
| Szyld BB PZ | INX | 34,72 | 42,70 |
| | M6 | 55,20 | 67,90 |
| Szyld WC | INX | 43,58 | 53,60 |
| | M6 | 59,67 | 73,40 |

Jane - R

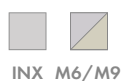

Szyld Slim-R



| | | Netto | Brutto |
|-----------------|-------|--------------|--------|
| Klamka dzielona | INX | 77,15 | 94,90 |
| | M6/M9 | 84,23 | 103,60 |
| Szyld BB PZ | INX | 32,20 | 39,60 |
| | M6 | 44,96 | 55,30 |
| Szyld WC | INX | 39,51 | 48,60 |
| | M6 | 55,69 | 68,50 |

Insignia - R



Szyld Slim-R



| | Netto | Brutto |
|-----------------|--------------|--------|
| Klamka dzielona | 71,87 | 88,40 |
| Szyld BB PZ | 44,96 | 55,30 |
| Szyld WC | 55,69 | 68,50 |

Insignia - QR



Szyld Slim-QR



| | Netto | Brutto |
|-----------------|--------------|--------|
| Klamka dzielona | 81,54 | 100,30 |
| Szyld BB PZ | 55,20 | 67,90 |
| Szyld WC | 59,67 | 73,40 |



Padwa - R



Szyld Slim-R

INX



| | Netto | Brutto |
|-----------------|--------------|--------|
| Klamka dzielona | 86,83 | 106,80 |
| Szyld BB PZ | 32,20 | 39,60 |
| Szyld WC | 39,51 | 48,60 |

Siena - R



Szyld Slim-R

INX



| | Netto | Brutto |
|-----------------|--------------|--------|
| Klamka dzielona | 86,83 | 106,80 |
| Szyld BB PZ | 32,20 | 39,60 |
| Szyld WC | 39,51 | 48,60 |

Jaro-QR eco



M6

Szyld Slim-QR

| | Netto | Brutto |
|-----------------|--------------|--------|
| Klamka dzielona | 71,06 | 87,40 |
| Szyld BB PZ | 55,20 | 67,90 |
| Szyld WC | 59,67 | 73,40 |

Jaro-R eco



M6

Szyld Slim-R

| | Netto | Brutto |
|-----------------|--------------|--------|
| Klamka dzielona | 66,67 | 82,00 |
| Szyld BB PZ | 44,96 | 55,30 |
| Szyld WC | 55,69 | 68,50 |

Liu-R



INX

Szyld Slim-R

| | Netto | Brutto |
|-----------------|--------------|--------|
| Klamka dzielona | 69,27 | 85,20 |
| Szyld BB PZ | 32,20 | 39,60 |
| Szyld WC | 39,51 | 48,60 |

Prado-R



INX

Szyld Slim-R

| | Netto | Brutto |
|-----------------|--------------|--------|
| Klamka dzielona | 70,16 | 86,30 |
| Szyld BB PZ | 32,20 | 39,60 |
| Szyld WC | 39,51 | 48,60 |

Presto-QR



M6

Szyld Slim-QR

| | Netto | Brutto |
|-----------------|---------------|--------|
| Klamka dzielona | 105,28 | 129,50 |
| Szyld BB PZ | 55,20 | 67,90 |
| Szyld WC | 59,67 | 73,40 |

Presto-R



M6

Szyld Slim-R

| | Netto | Brutto |
|-----------------|--------------|--------|
| Klamka dzielona | 68,37 | 84,10 |
| Szyld BB PZ | 44,96 | 55,30 |
| Szyld WC | 55,69 | 68,50 |

Sigma-QR



INX

Szyld Slim-QR

| | Netto | Brutto |
|-----------------|--------------|--------|
| Klamka dzielona | 82,44 | 101,40 |
| Szyld BB PZ | 34,72 | 42,70 |
| Szyld WC | 43,58 | 53,60 |

Sigma-R



INX

Szyld Slim-R

| | Netto | Brutto |
|-----------------|--------------|--------|
| Klamka dzielona | 70,16 | 86,30 |
| Szyld BB PZ | 32,20 | 39,60 |
| Szyld WC | 39,51 | 48,60 |

Uno-R



INX

Szyld Slim-R

| | Netto | Brutto |
|-----------------|--------------|--------|
| Klamka dzielona | 70,16 | 86,30 |
| Szyld BB PZ | 32,20 | 39,60 |
| Szyld WC | 39,51 | 48,60 |



POWRÓT
DO SIEBIE JEST
NAJBARDZIEJ
WYJĄTKOWY
NA ŚWIECIE.

9



SZYLDY



SZYLDY

950





BB



PZ

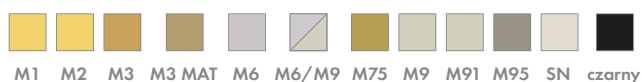

WC



| | Netto | Brutto |
|---------------|-------|--------|
| Szyld BB PZ | 13,58 | 16,70 |
| Szyld WC | 21,38 | 26,30 |

980





BB



PZ

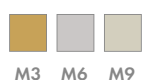

WC



| | Netto | Brutto |
|---------------|-------|--------|
| Szyld BB PZ | 16,02 | 19,70 |
| Szyld WC | 25,61 | 31,50 |

Jane-R AG1



BB



PZ



WC



| | Netto | Brutto |
|---------------|-------|--------|
| Szyld BB PZ | 10,65 | 13,10 |
| Szyld WC | 23,98 | 29,50 |

900



BB

PZ

WC



M3

| | Netto | Brutto |
|---------------|-------|--------|
| Szyld BB PZ | 13,58 | 16,70 |
| Szyld WC | 21,38 | 26,30 |

Econom - R



BB

PZ

WC



biały brąz

| | Netto | Brutto |
|---------------|-------|--------|
| Szyld BB PZ | 2,93 | 3,60 |
| Szyld WC | 5,77 | 7,10 |

Biskopt - R



BB

PZ

WC



biały brąz

| | Netto | Brutto |
|---------------|-------|--------|
| Szyld BB PZ | 3,90 | 4,80 |
| Szyld WC | 8,70 | 10,70 |

Tiger - R



BB

PZ

WC



M9

| | Netto | Brutto |
|---------------|-------|--------|
| Szyld BB PZ | 3,74 | 4,60 |
| Szyld WC | 7,40 | 9,10 |

EF Lui - R



BB

PZ

WC



INX

| | Netto | Brutto |
|---------------|-------|--------|
| Szyld BB PZ | 9,67 | 11,90 |
| Szyld WC | 20,24 | 24,90 |

EF 200



INX

| | Netto | Brutto |
|----------|-------|--------|
| Szyld WC | 30,65 | 37,70 |

Pro - R



BB

PZ

WC



M3 M9

| | Netto | Brutto |
|---------------|-------|--------|
| Szyld BB PZ | 6,67 | 8,20 |
| Szyld WC | 10,57 | 13,00 |

Slim - R



BB

PZ

WC



INX M6

| | Netto | Brutto |
|-------------------|-------|--------|
| Szyld BB PZ INX | 32,20 | 39,60 |
| Szyld BB PZ M6 | 44,96 | 55,30 |
| Szyld WC INX | 39,51 | 48,60 |
| Szyld WC M6 | 55,69 | 68,50 |

EF SN04 - QR



BB

PZ

WC



INX

| | Netto | Brutto |
|---------------|-------|--------|
| Szyld BB PZ | 12,93 | 15,90 |
| Szyld WC | 24,15 | 29,70 |

Slim - QR



BB

PZ

WC



INX M6

| | Netto | Brutto |
|-------------------|-------|--------|
| Szyld BB PZ INX | 34,72 | 42,70 |
| Szyld BB PZ M6 | 55,20 | 67,90 |
| Szyld WC INX | 43,58 | 53,60 |
| Szyld WC M6 | 59,67 | 73,40 |

Alma - QR



BB

PZ

WC



SN

| | Netto | Brutto |
|---------------|-------|--------|
| Szyld BB PZ | 16,99 | 20,90 |
| Szyld WC | 23,01 | 28,30 |

KW - QR



BB

PZ

WC



M6/M9

| | Netto | Brutto |
|---------------|-------|--------|
| Szyld BB PZ | 19,59 | 24,10 |
| Szyld WC | 27,24 | 33,50 |

Quanta - QR



BB



PZ



WC



| | Netto | Brutto |
|---------------|-------|--------|
| Szylc BB PZ | 19,59 | 24,10 |
| Szylc WC | 27,24 | 33,50 |

Quadro - QR



BB



PZ



WC



| | Netto | Brutto |
|---------------|-------|--------|
| Szylc BB PZ | 19,59 | 24,10 |
| Szylc WC | 27,24 | 33,50 |

Quadro - QR M6 / M9



BB



PZ



WC



| | Netto | Brutto |
|---------------|-------|--------|
| Szylc BB PZ | 19,59 | 24,10 |
| Szylc WC | 27,24 | 33,50 |

RT

BB

PZ

WC

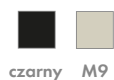

| | Netto | Brutto |
|---------------|-------|--------|
| Szyld BB PZ | 21,38 | 26,30 |
| Szyld WC | 26,99 | 33,20 |

B 0 4 - Q R**BINALIA**

BB

PZ

WC



| | Netto | Brutto |
|---------------|-------|--------|
| Szyld BB PZ | 24,47 | 30,10 |
| Szyld WC | 41,38 | 50,90 |

0006 Plus

| | Netto | Brutto |
|----------|-------|--------|
| Szyld PZ | 13,58 | 16,70 |

10710

| | Netto | Brutto |
|----------|-------|--------|
| Szyld PZ | 27,56 | 33,90 |

EF Owal

| | Netto | Brutto |
|----------|-------|--------|
| Szyld PZ | 21,87 | 26,90 |

Owalny Plus

| | Netto | Brutto |
|----------|-------|--------|
| Szyld PZ | 15,28 | 18,80 |

0003 / 6065



BB



PZ



WC



M1 M3 M6

| | Netto | Brutto |
|---------------|-------|--------|
| Szylc BB PZ | 43,01 | 52,90 |
| Szylc WC | 76,34 | 93,90 |

6060



BB



PZ



WC



M1 M3 M6 M75 M9

| | Netto | Brutto |
|---------------|-------|--------|
| Szylc BB PZ | 18,70 | 23,00 |
| Szylc WC | 43,74 | 53,80 |

555



BB



PZ



WC



M1 M1/M2 M6/M18 M6/M50 M6/M9 M7/M9 M9

| | Netto | Brutto |
|---------------|--------|--------|
| Szylc BB PZ | 47,32 | 58,20 |
| Szylc WC | 102,76 | 126,40 |

Prime - QR



BB



PZ



WC



M4 M6 czarny

| | Netto | Brutto |
|-----------------------|-------|--------|
| Szyld BB PZ Czarny | 30,00 | 36,90 |
| Szyld BB PZ M4 M6 | 32,44 | 39,90 |
| Szyld WC Czarny | 56,10 | 69,00 |
| Szyld WC M4 M6 | 64,23 | 79,00 |

546 - Q



BB



PZ



WC



M1/M2 M7/M9

| | Netto | Brutto |
|---------------|--------|--------|
| Szyld BB PZ | 49,11 | 60,40 |
| Szyld WC | 109,92 | 135,20 |

Oro - R



BB



PZ



WC

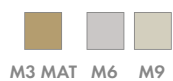

M3 MAT M6 M9

| | Netto | Brutto |
|---------------|-------|--------|
| Szyld BB PZ | 21,06 | 25,90 |
| Szyld WC | 26,75 | 32,90 |

Oro - QR



BB



PZ



WC



M3 MAT M6 M9 M91

| | Netto | Brutto |
|---------------|-------|--------|
| Szyld BB PZ | 21,06 | 25,90 |
| Szyld WC | 26,75 | 32,90 |



INSPIRUJĄCE
ODKRYCIA
ZNAJDUJĄ SIĘ
NA WYCIĄGNIĘ-
CIE RĘKI.

10



GAŁKI

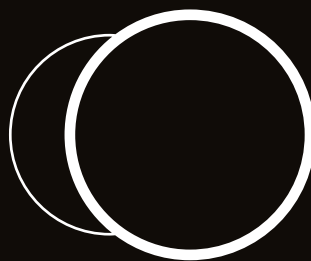

2055 - R**Szyld EF Lui-R**

| | Netto | Brutto |
|----------------------|--------------|--------|
| Gałka ruchoma (szt.) | 33,66 | 41,40 |
| Gałka stała (szt.) | 33,66 | 41,40 |
| Szyld BB PZ | 9,67 | 11,90 |
| Szyld WC | 20,24 | 24,90 |

2065 - QR**Szyld Quadro-QR**

| | Netto | Brutto |
|----------------------|--------------|--------|
| Gałka ruchoma (szt.) | 36,75 | 45,20 |
| Gałka stała (szt.) | 36,75 | 45,20 |
| Szyld BB PZ | 19,59 | 24,10 |
| Szyld WC | 27,24 | 33,50 |

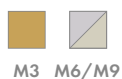
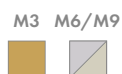
2075 - R**Szyld 950**

| | Netto | Brutto |
|----------------------|--------------|--------|
| Gałka ruchoma (kpl.) | 69,11 | 85,00 |
| Gałka stała (szt.) | 35,20 | 43,30 |
| Szyld BB PZ | 13,58 | 16,70 |
| Szyld WC | 21,38 | 26,30 |

AT - R eco**Szyld 950**

| | Netto | Brutto |
|----------------------|--------------|--------|
| Gałka ruchoma (kpl.) | 58,13 | 71,50 |
| Gałka stała (szt.) | 29,02 | 35,70 |
| Szyld BB PZ | 13,58 | 16,70 |
| Szyld WC | 21,38 | 26,30 |

6711 Prosta

**6871 Kula**

**Gałka z zamkiem**

| | Netto | Brutto |
|-------|-------|--------|
| Gałka | 36,10 | 44,40 |

Gałka z zamkiem

| | Netto | Brutto |
|-------|-------|--------|
| Gałka | 36,10 | 44,40 |

Apollo-R + gałka

**Szyld 0003/6065**

| | Netto | Brutto |
|--------------------|--------|--------|
| Gałka lewa prawa | 130,00 | 159,90 |
| Szyld BB PZ | 43,01 | 52,90 |
| Szyld WC | 76,34 | 93,90 |

Linoza - R



M6/M50 M7/M9



Szyld 555

M6/M50 M7/M9



| | Netto | Brutto |
|---------------|--------|--------|
| Galka | 143,90 | 177,00 |
| Szyld BB PZ | 47,32 | 58,20 |
| Szyld WC | 102,76 | 126,40 |

Piu Cristal



M6



Szyld 980

| | Netto | Brutto |
|----------------------|-------|--------|
| Galka ruchoma (szt.) | 75,37 | 92,70 |
| Szyld BB PZ | 16,02 | 19,70 |
| Szyld WC | 25,61 | 31,50 |

NAJCIEPLEJSZE
POWITANIA
CZEKAJĄ
U NASZYCH
DRZWI.



KLAMKI
DO DRZWI ZEWNĘTRZNYCH

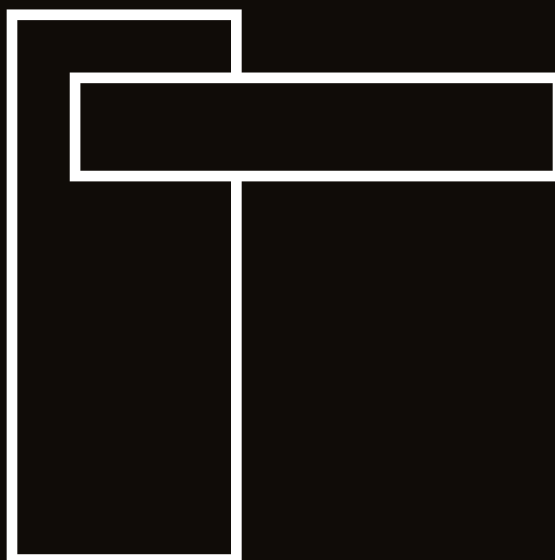

Alma zew. K+K**domino**

M3

Szyld Jane zew.

M3

| | Netto | Brutto |
|------------------------|--------------|--------|
| Klamka PZ lewa prawa | 73,66 | 90,60 |
| Szyld krótki PZ | 33,25 | 40,90 |

Galaxy zew. K+K**domino**

M3 MAT M91

Szyld 800 zew.

M3 MAT M91

| | Netto | Brutto |
|------------------------------|--------------|--------|
| Klamka dzielona lewa prawa | 50,00 | 61,50 |
| Szyld PZ | 14,47 | 17,80 |

Fokus zew. K+K**domino**

M3 MAT M8 M91

Szyld Fokus zew.

M3 MAT M8 M91

| | Netto | Brutto |
|-----------------|--------------|--------|
| Klamka PZ | 82,44 | 101,40 |
| Szyld krótki PZ | 29,84 | 36,70 |

Fokus zew. K+P**domino**

M3 MAT M91

Szyld Fokus zew.

M3 MAT M91

| | Netto | Brutto |
|------------------------|--------------|--------|
| Klamka PZ lewa prawa | 87,72 | 107,90 |
| Szyld krótki PZ | 29,84 | 36,70 |

Haga K+K**AXA**

F1 F4 F6 F9

Szyld Niagara

F1 F4
F9 INX

| | Netto | Brutto |
|-----------------------|--------------|--------|
| Klamka PZ kl. I | 99,11 | 121,90 |
| Szyld długi PZ kl. I | 43,33 | 53,30 |
| Szyld krótki PZ kl. I | 40,16 | 49,40 |



Jane zew. K+K

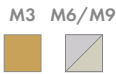
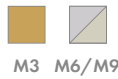

Szyld Jane zew.

| | Netto | Brutto |
|------------------------|-------|--------|
| Klamka PZ lewa prawa | 75,20 | 92,50 |
| Szyld krótki PZ | 33,25 | 40,90 |

Manitoba Plus K+K

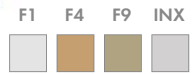

Szyld Manitoba

| | Netto | Brutto |
|--------------------|--------|--------|
| Klamka PZ kl. I | 106,42 | 130,90 |
| Szyld krótki kl. I | 40,16 | 49,40 |

Niagara K+K



Szyld Niagara

| | Netto | Brutto |
|-----------------------|-------|--------|
| Klamka PZ kl. I | 94,96 | 116,80 |
| Szyld długi PZ kl. I | 43,33 | 53,30 |
| Szyld krótki PZ kl. I | 40,16 | 49,40 |

Niagara K+P



Szyld Niagara

| | Netto | Brutto |
|-----------------------|--------|--------|
| Klamka PZ kl. I | 106,42 | 130,90 |
| Szyld długi PZ kl. I | 43,33 | 53,30 |
| Szyld krótki PZ kl. I | 40,16 | 49,40 |

Royal K+K



Szyld Royal

| | Netto | Brutto |
|----------------------|--------|--------|
| Klamka PZ kl. III | 199,27 | 245,10 |
| Szyld krótki kl. III | 105,37 | 129,60 |



Romana zew. K+K



Szyld Jane zew.

| | Netto | Brutto |
|------------------------|--------------|--------|
| Klamka PZ lewa prawa | 73,66 | 90,60 |
| Szyld krótki PZ | 33,25 | 40,90 |

Ottawa K+K



Szyld Ottawa

| | Netto | Brutto |
|-----------------|--------------|--------|
| Klamka PZ | 76,18 | 93,70 |
| Szyld krótki PZ | 30,24 | 37,20 |

Rondo K+G



Szyld Diec 7030

| | Netto | Brutto |
|--------------|---------------|--------|
| Klamka PZ | 133,90 | 164,70 |
| Szyld krótki | 109,19 | 134,30 |

Rondo K+K



Szyld Diec 7030

| | Netto | Brutto |
|--------------|---------------|--------|
| Klamka PZ | 145,93 | 179,50 |
| Szyld krótki | 109,19 | 134,30 |



Prestige K+K**AXA**

F1 F4 F6 F9

Szyld Prestige

F1 F4 F6 F9

Netto Brutto

| | | |
|-------------------------|---------------|--------|
| Klamka PZ kl. III | 199,27 | 245,10 |
| Szyld długi PZ kl. III | 104,72 | 128,80 |
| Szyld krótki PZ kl. III | 105,37 | 129,60 |

**Prestige K+K
z zabezpieczeniem****AXA**

F1 F4 F6 F9

**Szyld Prestige
z zabezpieczeniem**

F1 F4 F6 F9

Netto Brutto

| | | |
|-------------------------|---------------|--------|
| Klamka PZ kl. III | 226,34 | 278,40 |
| Szyld długi PZ kl. III | 136,67 | 168,10 |
| Szyld krótki PZ kl. III | 136,67 | 168,10 |

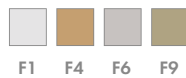
Prestige K+G**AXA**

F1 F4 F6 F9

Szyld Prestige

F1 F4 F6 F9

Netto Brutto

| | | |
|-------------------------|---------------|--------|
| Klamka PZ Kl. III | 212,76 | 261,70 |
| Szyld długi PZ Kl. III | 104,72 | 128,80 |
| Szyld krótki PZ Kl. III | 105,37 | 129,60 |

**Prestige K+G
z zabezpieczeniem****AXA**

F1 F4 F6 F9

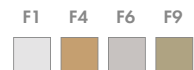
**Szyld Prestige
z zabezpieczeniem**

F1 F4 F6 F9

Netto Brutto

| | | |
|-------------------------|---------------|--------|
| Klamka PZ Kl. III | 245,12 | 301,50 |
| Szyld długi PZ Kl. III | 136,67 | 168,10 |
| Szyld krótki PZ Kl. III | 136,67 | 168,10 |



Space zew. K+K

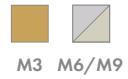

Szyld Space zew.



| | Netto | Brutto |
|------------------------|-------|--------|
| Klamka PZ lewa prawa | 73,98 | 91,00 |
| Szyld długi PZ | 26,18 | 32,20 |
| Szyld krótki PZ | 26,18 | 32,20 |

Ares
klamka bramowa



| | Netto | Brutto |
|-----------|-------|--------|
| Klamka PZ | 42,03 | 51,70 |

Hades P18
klamka bramowa



| | Netto | Brutto |
|-----------|-------|--------|
| Klamka PZ | 35,37 | 43,50 |



CIEKAWOŚĆ
ŚWIATA
ROZWIJAMY
W POCZUCIU
BEZPIECZEŃ-
-STWA.

12



KLAMKI
OKIENNE

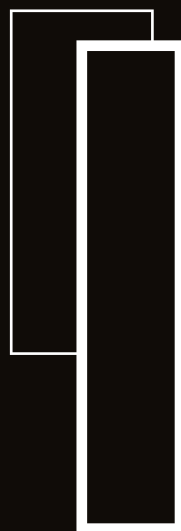

Pluton-O
+ zamek



-  F1
-  F4
-  F9

| | Netto | Brutto |
|----------------|-------|--------|
| Klamka okienna | 49,19 | 60,50 |

Pluton-O
+ zamek



-  biały
-  brąz

| | Netto | Brutto |
|----------------|-------|--------|
| Klamka okienna | 26,67 | 32,80 |

Pluton-O



-  biały
-  brąz

| | Netto | Brutto |
|----------------|-------|--------|
| Klamka okienna | 5,61 | 6,90 |

Pluton-O



-  F1
-  F4
-  F9

| | Netto | Brutto |
|----------------|-------|--------|
| Klamka okienna | 9,19 | 11,30 |

Mateo-O



-  M1/M2
-  M7/M9

| | Netto | Brutto |
|----------------|-------|--------|
| Klamka okienna | 92,20 | 113,40 |

Roma-O



-  M1/M2

| | Netto | Brutto |
|----------------|-------|--------|
| Klamka okienna | 99,19 | 122,00 |

Wenus-O



-  biały
-  brąz

| | Netto | Brutto |
|----------------|-------|--------|
| Klamka okienna | 2,76 | 3,40 |

Zita-O



-  M1/M2
-  M7/M9

| | Netto | Brutto |
|----------------|--------|--------|
| Klamka okienna | 127,80 | 157,20 |

Secustic-O



-  F35
-  F4
-  F9

| | Netto | Brutto |
|----------------|-------|--------|
| Klamka okienna | 20,98 | 25,80 |

Secustic-O
z kluczykiem



-  F35
-  F4
-  F9

| | Netto | Brutto |
|----------------|-------|--------|
| Klamka okienna | 93,82 | 115,40 |

Secustic-O
z przyciskiem



-  F35
-  F4
-  F9

| | Netto | Brutto |
|----------------|-------|--------|
| Klamka okienna | 83,09 | 102,20 |

Klamka okienna dachowa



-  biały
-  srebrny
-  szary

| | Netto | Brutto |
|----------------|-------|--------|
| Klamka okienna | 15,37 | 18,90 |



NAJPIĘKNIEJSZE
CHWILE NIE
DZIELĄ NAS
NA POKOLENIA.



13

AKCESORIA

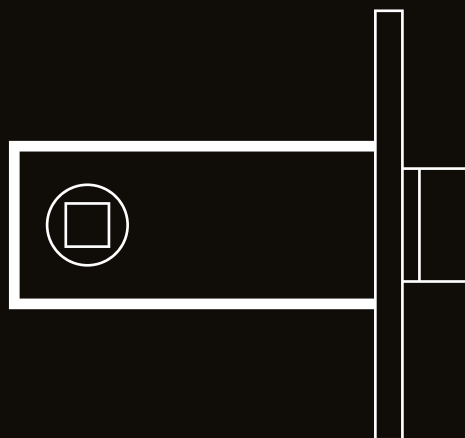

AKCESORIA



ZAMEK DO DRZWI SZKLANYCH V-100



Rygiel



Przeciwkaseta



Zawias V102



Rączki pasujące do zamka V-100

| |
|-----------|
| Aquila-R |
| Helena-R |
| Astoria-R |
| Delphi-R |
| Lavinia-R |
| Hera-RS-R |
| Lamia-R |
| Zita-R |
| Pallas-R |
| Roma-R |

- Zamek bez otworu lub z otworem na wkładkę bębnową.
- Zamek bez klamki w komplecie. Modele klamek pasujące do zamka w tabeli obok.
- Zestaw zawiera: zamek, zawiasy, osłonki na zawiasy i zestaw montażowy.



M9

| | Netto | Brutto |
|-----------------|---------------|---------|
| Zamek B/O V-100 | 973,09 | 1196,90 |
| Zamek PZ V-100 | 973,09 | 1196,90 |
| Zawias V102 | 256,02 | 314,90 |
| Rygiel | 256,02 | 314,90 |
| Przeciwkaseta | 845,04 | 1039,40 |

ZAMEK DO DRZWI SZKLANYCH V-5000



- Zamek bez otworu lub z otworem na wkładkę bębnową.
- Zestaw zawiera: zamek, zawiasy, osłonki na zawiasy i zestaw montażowy.
- Zestaw z klamką Sky w komplecie.



M9

| | Netto | Brutto |
|--------------------|---------------|--------|
| Zamek B/O + klamka | 772,36 | 950,00 |
| Zamek PZ+ klamka | 772,36 | 950,00 |

ZAMEK DO DRZWI SZKLANYCH V-6000



- Zamek bez otworu, z otworem na wkładkę bębnową lub WC.
- Zestaw zawiera: zamek, zawiasy, osłonki na zawiasy i zestaw montażowy.
- Zestaw z klamką Uno w komplecie.



INX

| | Netto | Brutto |
|--------------------|---------------|--------|
| Zamek B/O + klamka | 646,18 | 794,80 |
| Zamek PZ + klamka | 646,18 | 794,80 |
| Zamek WC + klamka | 807,72 | 993,50 |



POCHWYT HOMER 4024



| | Netto | Brutto |
|-----------|-------|--------|
| Prostokąt | 12,11 | 14,90 |
| Owal | 11,54 | 14,20 |
| Kwadrat | 11,54 | 14,20 |

POCHWYT HOMER 3924

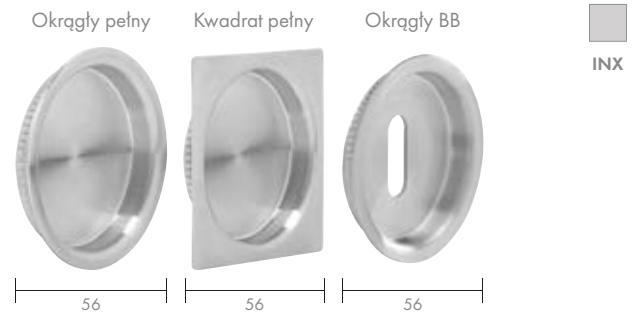

| | Netto | Brutto |
|---------------|-------|--------|
| Okrągły pełny | 11,54 | 14,20 |
| Kwadrat pełny | 11,87 | 14,60 |
| Okrągły BB | 11,54 | 14,20 |

POCHWYT 095 MOSIĘŻNY



| | M1 | M3 | M9 |
|--------|-------|-------|-------|
| Netto | 26,42 | 26,42 | 26,42 |
| Brutto | 32,50 | 32,50 | 32,50 |

POCHWYT BALKONOWY



| | Netto | Brutto |
|--|-------|--------|
| | 5,45 | 6,70 |

POCHWYT TWORZYWO



| | biały | brąz | złoty | nikiel | orzech |
|--------|-------|------|-------|--------|--------|
| Netto | 2,76 | 2,76 | 3,74 | 3,74 | 2,76 |
| Brutto | 3,40 | 3,40 | 4,60 | 4,60 | 3,40 |

POCHWYT HOMER NAPARSTEK

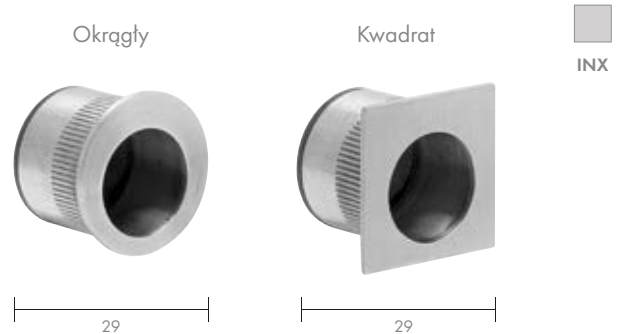

| | Netto | Brutto |
|---------|-------|--------|
| Okrągły | 5,45 | 6,70 |
| Kwadrat | 5,28 | 6,50 |



TULEJE WENTYLACYJNE Ø 22
mosiężne (szt.)

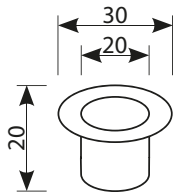

| Netto | Brutto |
|-------|--------|
| 8,21 | 10,10 |

TULEJE WENTYLACYJNE Ø 30
mosiężne

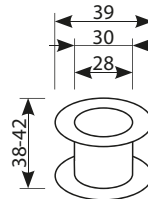

| Netto | Brutto |
|-------|--------|
| 19,27 | 23,70 |

TULEJE WENTYLACYJNE Ø 35
mosiężne (szt.)

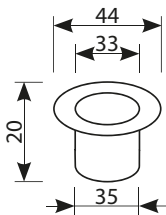

| Netto | Brutto |
|-------|--------|
| 9,11 | 11,20 |

TULEJE WENTYLACYJNE Ø 40
mosiężne, grubość: 35-38 mm

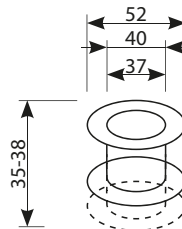

| Netto | Brutto |
|-------|--------|
| 22,93 | 28,20 |

TULEJE WENTYLACYJNE Ø 40
mosiężne, grubość: 38-42 mm

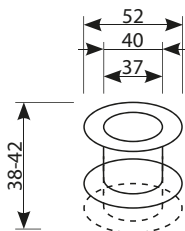

| Netto | Brutto |
|-------|--------|
| 22,93 | 28,20 |

TULEJE WENTYLACYJNE
OKRĄGŁE Ø 40 stalowe,
grubość: 38-42 mm

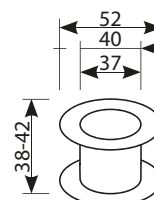

| Netto | Brutto |
|-------|--------|
| 9,11 | 11,20 |



**TULEJE WENTYLACYJNE
OKRĄGŁE SS Ø 40 stalowe,
grubość: 30-40 mm**

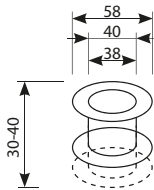

M3 M6 M9

| Netto | Brutto |
|-------|--------|
| 16,18 | 19,90 |

**TULEJE WENTYLACYJNE
OKRĄGŁE SS Ø 40 stalowe,
grubość: 36-46 mm**

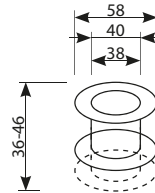

M3 M9

| Netto | Brutto |
|-------|--------|
| 16,18 | 19,90 |

**TULEJE WENTYLACYJNE
KWADRATOWE SS Ø 40
stalowe, grubość: 36-46 mm**

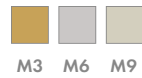
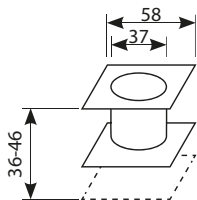

M3 M6 M9

| Netto | Brutto |
|-------|--------|
| 16,18 | 19,90 |

**TULEJE WENTYLACYJNE
KWADRATOWE SS Ø 40
stalowe, grubość: 30-40 mm**

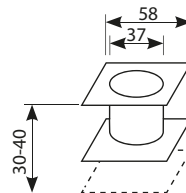

M3 M9

| Netto | Brutto |
|-------|--------|
| 16,18 | 19,90 |

TULEJE TWORZYWO

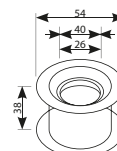

| | chrom | złoty | srebrny mat | złoty mat | pozostałe kolory |
|--------|-------|-------|-------------|-----------|------------------|
| Netto | 2,68 | 2,68 | 3,66 | 3,66 | 0,89 |
| Brutto | 3,30 | 3,30 | 4,50 | 4,50 | 1,10 |



**CYFRY 19 CM:
OD 0 DO 9****CYFRY 10 CM:
OD 0 DO 9****CYFRY 20 CM:
OD 0 DO 9**

Przykręcane PCV

Przykręcane

Przykręcane



| | |
|--------|--------|
| | czarny |
| Netto | 9,11 |
| Brutto | 11,20 |

| | |
|--------|-------|
| | M1 |
| Netto | 20,16 |
| Brutto | 24,80 |

| | |
|--------|-------|
| | M1 |
| Netto | 45,93 |
| Brutto | 56,50 |

**CYFRY 5 CM:
OD 0 DO 9****CYFRY INV**

Samoprzylepne

Samoprzylepne PCV



| | | | |
|--------|------------|----------|-----------------|
| | M4 brąz | M6 SN | patyna złoty |
| Netto | 3,82 | 4,63 | 5,61 |
| Brutto | 4,70 | 5,70 | 6,90 |

| | | | | | |
|--------|--------|--------|---------|---------|-------|
| | grafit | oliwka | srebrny | srebrny | złoty |
| Netto | 4,63 | 4,63 | 4,63 | 4,63 | 4,63 |
| Brutto | 5,70 | 5,70 | 5,70 | 5,70 | 5,70 |

LITERY INV**OZNACZENIA WC****OZNACZENIE WC**

Samoprzylepne PCV

Samoprzylepne

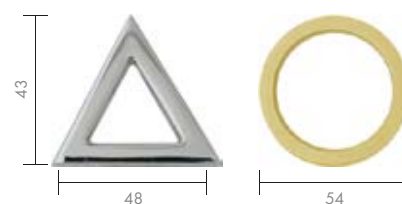

| | | | | |
|--------|--------|--------|--------|-------|
| | grafit | oliwka | srebro | złoty |
| Netto | 4,63 | 4,63 | 4,63 | 4,63 |
| Brutto | 5,70 | 5,70 | 5,70 | 5,70 |

| | | |
|--------|-------|-------|
| | M1 | M6 |
| Netto | 11,30 | 14,23 |
| Brutto | 13,90 | 17,50 |

| | | |
|--------|-------|-------|
| | M6 | M1 |
| Netto | 14,23 | 12,68 |
| Brutto | 17,50 | 15,60 |



OZNACZENIA WC

Samoprzylepne PCV

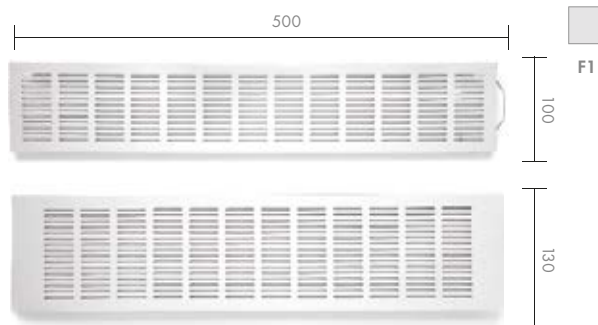

| | grafit | oliwka | srebrny | złoty |
|--------------|--------------|--------------|--------------|--------------|
| Netto | 10,08 | 10,08 | 10,08 | 10,08 |
| Brutto | 12,40 | 12,40 | 12,40 | 12,40 |

KRATKI WENTYLACYJNE

| | Netto | Brutto |
|---------------|--------------|--------|
| 100x500 (szt) | 52,11 | 64,10 |
| 130x500 (szt) | 53,74 | 66,10 |

ELEKTROZACZEPYZaczep płaski
długi/krótkiZaczep kątowy
długi

Elektrozaczep R3 z blokadą



ocynk srebrny



Elektrozaczep R3 z blokadą i pamięcią

| | Netto | Brutto |
|---------------------------------------|--------------|--------|
| Elektrozaczep R3 z blokadą | 77,89 | 95,80 |
| Elektrozaczep R3 z blokadą i pamięcią | 86,02 | 105,80 |
| Zaczep kątowy długi | 12,11 | 14,90 |
| Zaczep płaski długi/krótki | 11,14 | 13,70 |
| Zaczep płaski długi/krótki | 10,49 | 12,90 |

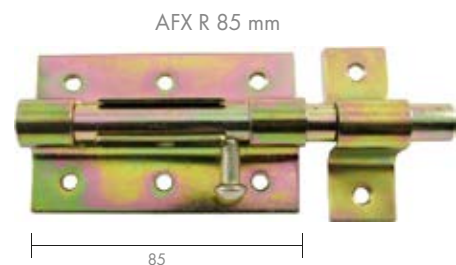
ZASUWA AFX

AFX R 85 mm

ocynk złoty

| | Netto | Brutto |
|--------------|--------------|--------|
| AFX R 70 mm | 4,72 | 5,80 |
| AFX R 85 mm | 6,18 | 7,60 |
| AFX R 100 mm | 7,07 | 8,70 |
| AFX R 120 mm | 8,21 | 10,10 |
| AFX R 140 mm | 9,19 | 11,30 |

ZAMEK OSZCZĘDNOŚCIOWY

 egl malowany

 chrom

| | Netto | Brutto |
|--|--------------|--------|
| | 5,37 | 6,60 |



ZAMEK JANIA BRAMOWY + blacha w komplecie**JANIA**

czarny

| | | Netto | Brutto |
|-------|---------|--------------|--------|
| 90/22 | Wkładka | 18,29 | 22,50 |
| | Klucz | 19,51 | 24,00 |
| 90/63 | Wkładka | 28,29 | 34,80 |

ZAMEK JANIA WĄSKOPROFILOWY + blacha w komplecie**JANIA**

czarny

| | | Netto | Brutto |
|-------|-------|--------------|--------|
| 72/34 | Prawy | 21,30 | 26,20 |
| | Lewy | 21,30 | 26,20 |
| | Rolka | 21,30 | 26,20 |

ZAMEK JANIA + blacha w komplecie**JANIA**

eł malowany

| | | Netto | Brutto |
|---------------------|----------|--------------|--------|
| 60/50 | BB/PZ/WC | 14,96 | 18,40 |
| 72/50 | BB/PZ/WC | 15,61 | 19,20 |
| 90/50 | BB/PZ/WC | 13,58 | 16,70 |
| 72/55 lewy/prawy | BB/PZ/WC | 13,74 | 16,90 |
| 72/60 | BB/PZ/WC | 16,34 | 20,10 |



**ZAMEK JANIA
BEZKLUZOWY**



■
egl malowany

**ZAMEK JANIA
NAWIERZCHNIOWY**



■
egl malowany

| Netto | Brutto |
|-------|--------|
| 9,19 | 11,30 |

| Netto | Brutto |
|-------|--------|
| 23,74 | 29,20 |

ZAMEK BODA JEDNOSTRONNY

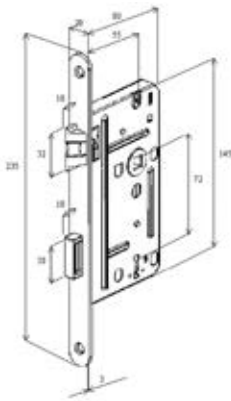

4240 Lewy / prawy
Klucz

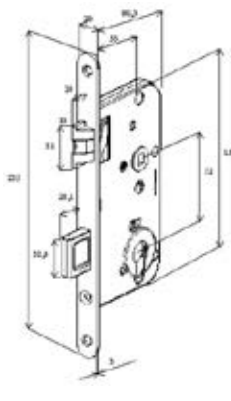

4242 Lewy / prawy
Wkładka

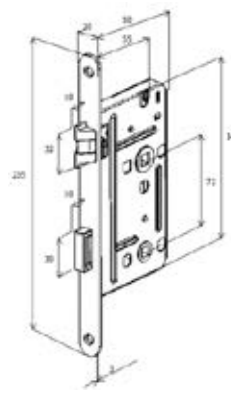

4261 Lewy / prawy
WC

| | chrom | egl malowany |
|--------|-------|--------------|
| Netto | 21,46 | 16,83 |
| Brutto | 26,40 | 20,70 |

ZAMEK BODA

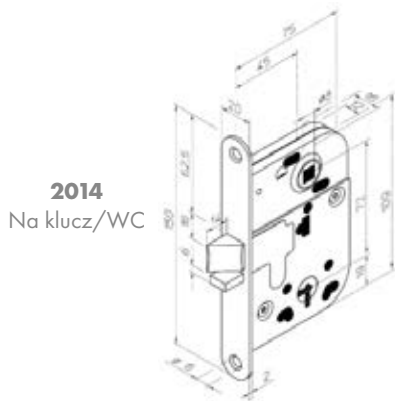

2014
Na klucz/WC



2018 Na wkładkę
bębenkową

■ chrom ■ egl malowany

| | Netto | Brutto |
|---------------------------|-------|--------|
| 2018 Na wkładkę bębenkową | 25,04 | 30,80 |
| 2018 Na wkładkę bębenkową | 21,14 | 26,00 |
| 2014 Na klucz/WC | 21,14 | 26,00 |



BLACHY ZACZEPOWE BODA

ASSA ABLOY

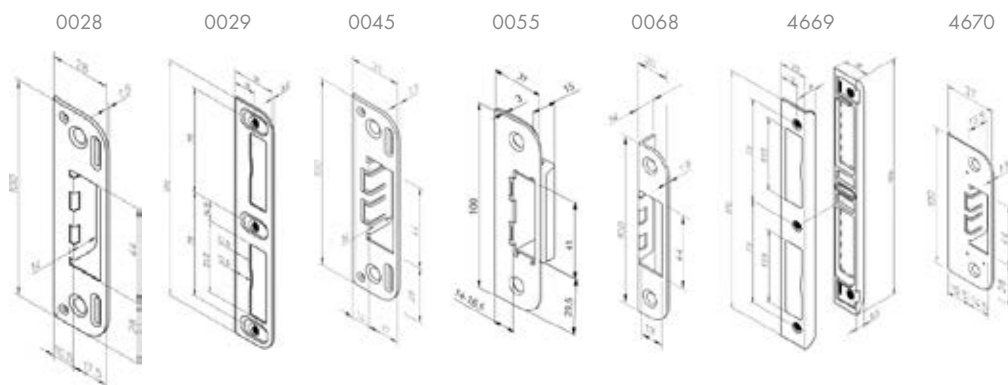

chrom egl malowany

| | Netto | Brutto |
|------|-------|--------|
| 0028 | 2,68 | 3,30 |
| 0029 | 6,50 | 8,00 |
| 0045 | 2,68 | 3,30 |
| 0068 | 2,76 | 3,40 |
| 4669 | 5,61 | 6,90 |
| 0055 | 6,10 | 7,50 |
| 4670 | 3,66 | 4,50 |

ZAMEK HAKOWY HOMER OKRĄGŁY

Zestaw na klucz BB

Zestaw WC

Zestaw do drzwi przesuwnych zawiera:

- zamek hakowy,
- komplet szyldów,
- pochwyty.

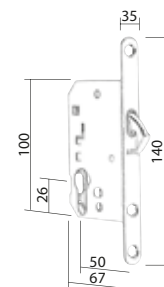

| Netto | Brutto |
|-------|--------|
| 89,35 | 109,90 |

ZAMEK B-FORTY

960 BB

961 WC

969 PZ

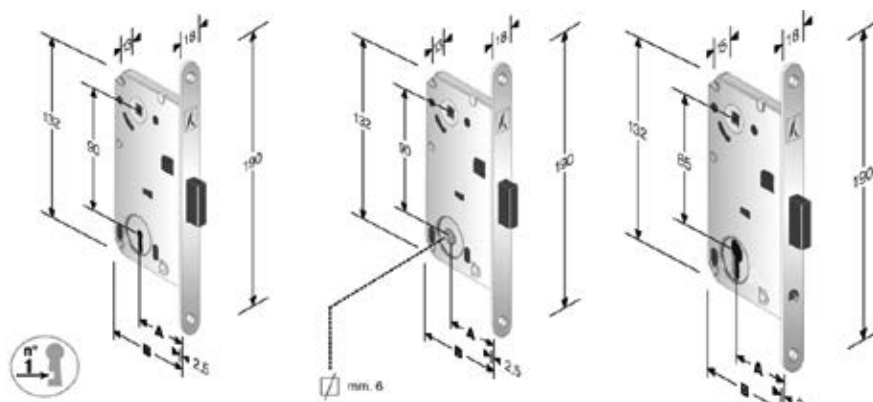

M4

| | Netto | Brutto |
|--------|-------|--------|
| 960 BB | 52,28 | 64,30 |
| 961 WC | 52,68 | 64,80 |
| 969 PZ | 54,72 | 67,30 |

ZAMEK B-TWIN

940 BB

941 WC

949 PZ



| | Netto | Brutto |
|--------|--------------|--------|
| 940 BB | 44,47 | 54,70 |
| 941 WC | 52,11 | 64,10 |
| 949 PZ | 53,01 | 65,20 |

**BLACHA DO ZAMKA
MAGNETYCZNEGO B-TWIN**

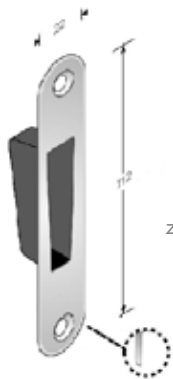

Blacha zaczepowa



Blacha regulowana

| | Netto | Brutto |
|-------------------|--------------|--------|
| Blacha regulowana | 26,59 | 32,70 |
| Blacha zaczepowa | 16,50 | 20,30 |

**BLACHA DO ZAMKA
MAGNETYCZNEGO B-FORTY**



Blacha zaczepowa



Blacha regulowana

| | Netto | Brutto |
|-------------------|--------------|--------|
| Blacha regulowana | 27,56 | 33,90 |
| Blacha zaczepowa | 20,16 | 24,80 |

ZAMEK HOMER + blacha w komplecie

10404 BB

10405 PZ

10406 WC

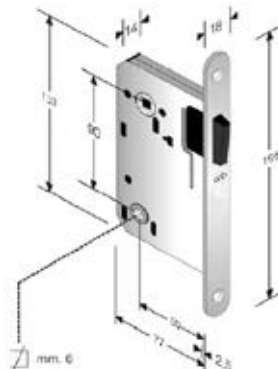

| | Netto | Brutto |
|--|--------------|--------|
| | 35,69 | 43,90 |



ODBOJNIKI KULISTE



Odbojnik kulisty przyklejany



| | Netto | Brutto |
|------------------------------|-------|--------|
| Odbojnik kulisty | 7,07 | 8,70 |
| Odbojnik kulisty przyklejany | 7,64 | 9,40 |

ODBOJE MOSIĘŻNE



Podłoga niski



| Netto | Brutto |
|-------|--------|
| 19,27 | 23,70 |

ODBOJE MOSIĘŻNE



Podłoga



| Netto | Brutto |
|-------|--------|
| 19,27 | 23,70 |

ODBOJE MOSIĘŻNE



Ściana



| Netto | Brutto |
|-------|--------|
| 19,27 | 23,70 |

ODBOJE GUMOWE



| | Netto | Brutto |
|----------|-------|--------|
| standard | 1,71 | 2,10 |
| medium | 7,07 | 8,70 |
| maxi | 20,81 | 25,60 |



ODBOJE TWORZYWO

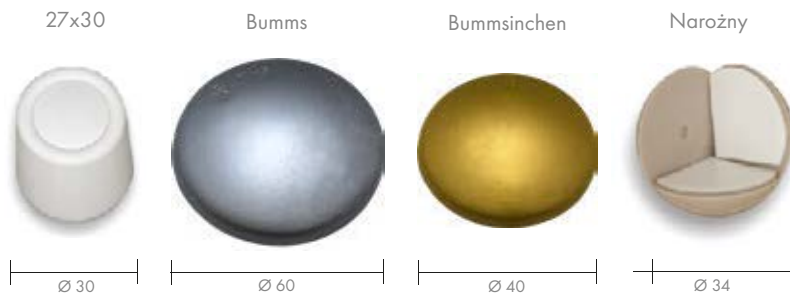

| | | Netto | Brutto |
|-------------|--|-------------|--------|
| 27x30 | beż biały brąz przezroczysty | 2,68 | 3,30 |
| Bumms | beż biały brąz srebrny szary złoty | 3,98 | 4,90 |
| Bummsinchen | beż biały brąz srebrny szary złoty | 3,58 | 4,40 |
| Narożny | beż biały brąz | 3,66 | 4,50 |

ODBOJE

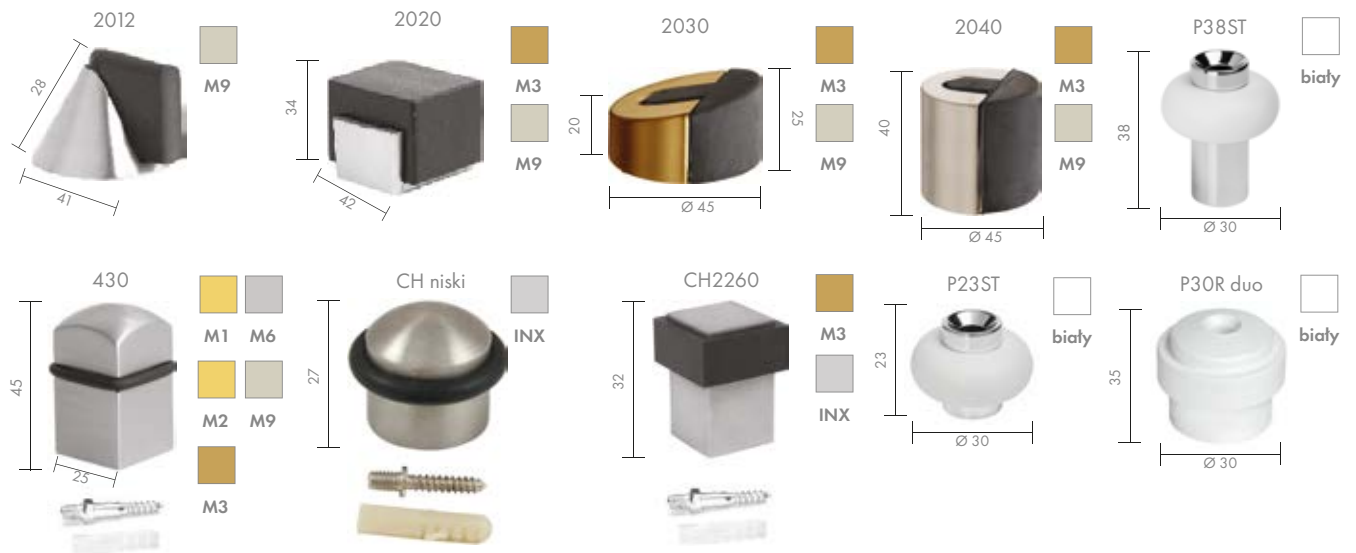

| | Netto | Brutto |
|---------------|--------------|--------|
| 430 | 21,06 | 25,90 |
| 2012 | 20,57 | 25,30 |
| 2020 | 9,11 | 11,20 |
| 2030 | 10,08 | 12,40 |
| 2040 | 13,01 | 16,00 |
| CH niski | 11,54 | 14,20 |
| CH2260 | 9,11 | 11,20 |
| P23ST | 10,08 | 12,40 |
| P38ST | 10,98 | 13,50 |
| P40ST ścienny | 18,37 | 22,60 |
| P84ST ścienny | 11,87 | 14,60 |
| P98ST ścienny | 13,74 | 16,90 |
| P30R duo | 3,58 | 4,40 |
| P35B kula | 3,58 | 4,40 |
| CH1299 | 11,54 | 14,20 |
| CH1699 | 15,69 | 19,30 |



STOPERY



306



| | Netto | Brutto |
|---------------|---|--------------------|
| Stoper DS-S03 | brąz grafiatto nikiel lakierowany | 16,75 20,60 |
| Stoper DB-04 | brąz grafiatto nikiel lakierowany | 16,75 20,60 |
| 306 | mosiądz lakierowany nikiel lakierowany | 17,80 21,90 |

OSŁONKI ZAWIASU 13,5 X 80, TWORZYWO 4 sztuki



| | biały | M1 | M2 | M3 PAT | M4 | M6 | M9 |
|--------|-------------|-------------|-------------|-------------|-------------|-------------|-------------|
| Netto | 2,52 | 4,72 | 4,72 | 2,52 | 4,72 | 4,72 | 4,72 |
| Brutto | 3,10 | 5,80 | 5,80 | 3,10 | 5,80 | 5,80 | 5,80 |

OSŁONKI ZAWIASU, ALUMINIUM 4 sztuki



| | M1 | M3 | M4 | M6 | M9 | czarny |
|--------|--------------|--------------|--------------|--------------|--------------|--------------|
| Netto | 11,79 | 11,79 | 11,79 | 11,79 | 11,79 | 11,79 |
| Brutto | 14,50 | 14,50 | 14,50 | 14,50 | 14,50 | 14,50 |
| Netto | 11,79 | 11,79 | 11,79 | 11,79 | 11,79 | 11,79 |
| Brutto | 14,50 | 14,50 | 14,50 | 14,50 | 14,50 | 14,50 |
| Netto | 12,28 | 12,28 | 12,28 | 12,28 | 12,28 | 12,28 |
| Brutto | 15,10 | 15,10 | 15,10 | 15,10 | 15,10 | 15,10 |
| Netto | 13,66 | 13,66 | 13,66 | 13,66 | 13,66 | - |
| Brutto | 16,80 | 16,80 | 16,80 | 16,80 | 16,80 | - |

ZAWIAS KUBICA



6200 H2

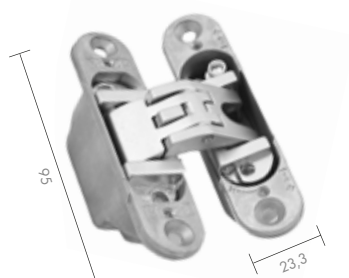
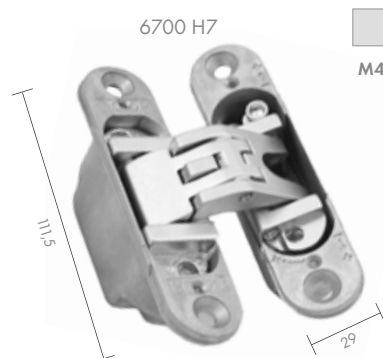

| | Netto | Brutto |
|---------|---------------|--------|
| 6200 H2 | 127,07 | 156,30 |
| 6700 H7 | 132,52 | 163,00 |

ZAWIAS 830



| | Netto | Brutto |
|--------------------|---------------|--------|
| 830-19/95 (2 szt.) | 147,15 | 181,00 |
| 830-19/95 (szt.) | 73,66 | 90,60 |



ZAWIAS REGULOWANY



| | | ocynk złoty | ocynk srebrny |
|-------------------------------|--------------|--------------|---------------|
| Ø 14 regulowany 14/80 stal | Netto | 10,16 | 10,16 |
| | Brutto | 12,50 | 12,50 |

ZAWIAS REGULOWANY

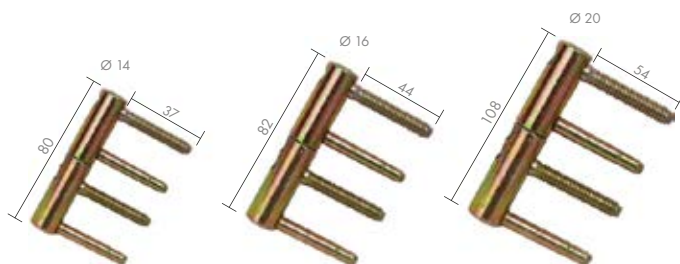

| | | ocynk srebrny | ocynk złoty |
|-------------------------------|--------------|---------------|--------------|
| Ø 14 regulowany Exacta 495 | Netto | 12,36 | 12,36 |
| | Brutto | 15,20 | 15,20 |
| Ø 16 regulowany Exacta 495 | Netto | 16,50 | 16,50 |
| | Brutto | 20,30 | 20,30 |
| Ø 20 regulowany Exacta 495 | Netto | 23,82 | 23,82 |
| | Brutto | 29,30 | 29,30 |

ZAWIAS REGULOWANY

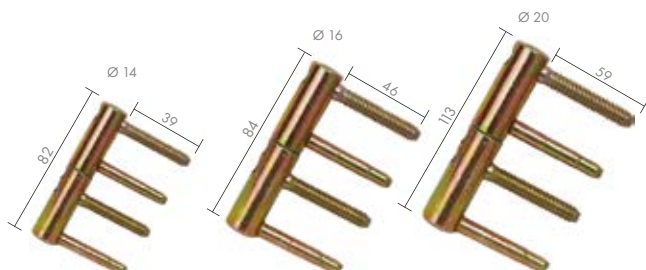

| | | ocynk złoty |
|-----------------|--------------|--------------|
| Ø 14 regulowany | Netto | 10,89 |
| | Brutto | 13,40 |
| Ø 16 regulowany | Netto | 13,90 |
| | Brutto | 17,10 |
| Ø 20 regulowany | Netto | 20,89 |
| | Brutto | 25,70 |

ZAWIAS MOSIĘŻNY

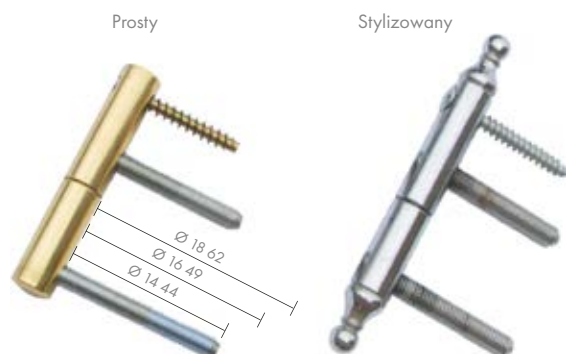

| | | mosiądz lakierowany | patyna | chrom satynowany | chrom lakierowany |
|------------------------------------|--------------|------------------------|--------------|---------------------|----------------------|
| Ø 14 prosty 14/91 mosiądz | Netto | 24,63 | 24,63 | 24,63 | 24,63 |
| | Brutto | 30,30 | 30,30 | 30,30 | 30,30 |
| Ø 14 stylizowany 14/119 mosiądz | Netto | 25,61 | 24,63 | 24,63 | 24,63 |
| | Brutto | 31,50 | 30,30 | 30,30 | 30,30 |
| Ø 16 prosty 16/107 mosiądz | Netto | 27,72 | 27,72 | 27,72 | 27,72 |
| | Brutto | 34,10 | 34,10 | 34,10 | 34,10 |
| Ø 16 stylizowany 16/135 mosiądz | Netto | 29,76 | 29,76 | 29,76 | 29,76 |
| | Brutto | 36,60 | 36,60 | 36,60 | 36,60 |
| Ø 18 prosty 18/114 mosiądz | Netto | - | 36,99 | - | - |
| | Brutto | - | 45,50 | - | - |
| Ø 18 stylizowany 18/160 mosiądz | Netto | 38,05 | 38,05 | 38,05 | 38,05 |
| | Brutto | 46,80 | 46,80 | 46,80 | 46,80 |



WIZJERY



| | brąz grafiatto | nikiel lakierowany |
|-----------------------|-------------------|--------------------|
| Wizjer Ø 14 30/50/160 | Netto 7,07 | 7,07 |
| | Brutto 8,70 | 8,70 |
| Wizjer Ø 16 30/50/180 | Netto 9,76 | 9,76 |
| | Brutto 12,00 | 12,00 |

WIZJERY

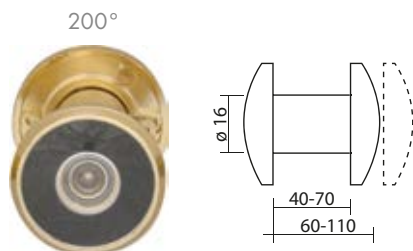

| | M1 | M3 | M4 | M6 | M9 |
|-------------|--------------------|--------------|--------------|--------------|--------------|
| Wizjer Ø 16 | Netto 21,06 | 21,06 | - | 21,06 | 21,06 |
| 40/70/200 | Brutto 25,90 | 25,90 | - | 25,90 | 25,90 |
| Wizjer Ø 16 | Netto 21,38 | 21,38 | - | 21,38 | - |
| 60/110/200 | Brutto 26,30 | 26,30 | - | 26,30 | - |
| Wizjer Ø 16 | Netto - | - | 21,06 | - | - |
| 60/92/160 | Brutto - | - | 25,90 | - | - |

ZESTAW MONTAŻOWY KLAMKI



| | mosiądz lakierowany | | brąz grafiatto | | nikiel lakierowany | |
|--------|---------------------|--------|----------------|--------|--------------------|--------|
| | Netto | Brutto | Netto | Brutto | Netto | Brutto |
| 120 mm | - | - | 6,99 | 8,60 | 6,99 | 8,60 |
| 140 mm | 6,99 | 8,60 | 6,99 | 8,60 | 6,99 | 8,60 |

REDUKTORY ŚREDNICY PRĘTA WC



| | Netto | Brutto |
|------|-------------|--------|
| 4/5 | 1,71 | 2,10 |
| 4/6 | 1,71 | 2,10 |
| 4/8 | 1,71 | 2,10 |
| 8/9 | 1,71 | 2,10 |
| 8/10 | 1,71 | 2,10 |

PRĘT KWADRATOWY

ŚRUBY PRZELOTOWE

WKRĘTY DO KLAMEK

ŚRUBKA IMBUSOWA

stalowa

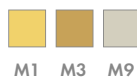

| | Netto | Brutto |
|-------|-------------|--------|
| 4x70 | 2,03 | 2,50 |
| 8x100 | 3,66 | 4,50 |
| 8x120 | 3,66 | 4,50 |
| 8x140 | 3,66 | 4,50 |
| 8x160 | 4,63 | 5,70 |



| | Netto | Brutto |
|----------------|-------------|--------|
| Ø 7,5 (2 szt.) | 5,61 | 6,90 |



| | Netto | Brutto |
|-----------------|-------------|--------|
| 3,5x20 (4 szt.) | 1,71 | 2,10 |



| | Netto | Brutto |
|-------------|-------------|--------|
| Ø 5 lub Ø 6 | 0,81 | 1,00 |



SAMOZAMYKACZ D500 z ramieniem

| | Netto | Brutto |
|------|--------|--------|
| D500 | 107,56 | 132,30 |

SAMOZAMYKACZ D900 z ramieniem

| | Netto | Brutto |
|------|--------|--------|
| D900 | 122,93 | 151,20 |

SAMOZAMYKACZ D2000 z ramieniem

| | Netto | Brutto |
|-------|--------|--------|
| D2000 | 181,38 | 223,10 |

RAMIĘ z blokadą

| | Netto | Brutto |
|-------|-------|--------|
| D900 | 67,56 | 83,10 |
| D500 | 67,56 | 83,10 |
| D2000 | 73,66 | 90,60 |

DANE TECHNICZNE

| | siła wg EN 1154 | | | maksymalna | | regulowana prędkość zamykania w zakresie (stopnie) | regulowana końcowa faza domknięcia w zakresie (stopnie) | ilumienie otwarcia | arrest ppoż EI 120 | montaż po stronie zawiasów na skrzydle | montaż po stronie zawiasów ościeżnicy | montaż na drzwiach całoszklanych |
|--------------------------------|-----------------|---|---|-------------------------|--------------------|--|---|--------------------|--------------------|--|---------------------------------------|----------------------------------|
| | 2 | 3 | 4 | szerokość skrzydła (mm) | waga skrzydła (kg) | | | | | | | |
| Samozamykacz D500 z ramieniem | | | | 1000 | 40-60 | 180-15 | 15-0 | nd | ✓ | ✓ | ✓ | nd |
| Samozamykacz D900 z ramieniem | | ✓ | | 800-1000 | 40-60 | 180-15 | 15-0 | nd | ✓ | ✓ | ✓ | nd |
| Samozamykacz D2000 z ramieniem | ✓ | ✓ | ✓ | 800-1000 | 20-80 | 180-15 | 15-0 | ✓ | ✓ | ✓ | ✓ | nd |



TS 1000 z ramieniem**GEZE**

biały brąz srebrny

TS 1500 z ramieniem**GEZE**

biały brąz srebrny

| | Netto | Brutto |
|---------------------|---------------|--------|
| TS 1000 z ramieniem | 144,72 | 178,00 |

| | Netto | Brutto |
|---------------------|---------------|--------|
| TS 1500 z ramieniem | 167,80 | 206,40 |

TS 2000 V z ramieniem**GEZE**

biały brąz srebrny

TS 1500 z ramieniem z blokadą**GEZE**

biały brąz srebrny

| | Netto | Brutto |
|-----------------------|---------------|--------|
| TS 2000 V z ramieniem | 199,84 | 245,80 |

| | Netto | Brutto |
|-------------------------------|---------------|--------|
| TS 1500 z ramieniem z blokadą | 247,97 | 305,00 |

TS 2000 V-BC z ramieniem**GEZE**

biały brąz srebrny

TS 2000 V z ramieniem z blokadą**GEZE**

biały brąz srebrny

| | Netto | Brutto |
|-------------------------|---------------|--------|
| TS 2000 VBC z ramieniem | 212,68 | 261,60 |

| | Netto | Brutto |
|---------------------------------|---------------|--------|
| TS 2000 V z ramieniem z blokadą | 294,39 | 362,10 |



TS 3000 V bez szyny**GEZE**

biały brąz srebrny

**Netto** Brutto

| | | |
|---------------------|---------------|--------|
| TS 3000 V bez szyny | 408,05 | 501,90 |
|---------------------|---------------|--------|

SZYNY ŚLIZGOWE**GEZE**

biały brąz srebrny

**Netto** Brutto

| | | |
|----------------|---------------|--------|
| TS 1500 | 112,52 | 138,40 |
| TS 4000/2000 | 134,23 | 165,10 |
| TS 5000/3000 V | 108,62 | 133,60 |

DANE TECHNICZNE

| | siła wg EN 1154 | | | | | siła regulowana | | maksymalna | | regulowana prędkość zamykania w zakresie (stopnie) | regulowana końcowa faza domknięcia w zakresie (stopnie) | filumienie otwarcia | atest ppoż | montaż po stronie zawiasów na skrzydle | montaż po stronie zawiasów ościeżnicy | montaż na drzwiach całoszklanych |
|-------------------------------------|-----------------|---|---|---|---|-----------------|-----------------------|-------------------------|--------------------|--|---|---------------------|------------|--|---------------------------------------|----------------------------------|
| | 2 | 3 | 4 | 5 | 6 | plynnie | poprzez przestawienie | szerokość skrzydła (mm) | waga skrzydła (kg) | | | | | | | |
| TS 3000 V z szyną ślizgową | ✓ | ✓ | ✓ | | | ✓ | | 1100 | 80 | 180-15 | 15-0 | ✓ | ✓ | ✓ | ✓ | opcja ** |
| TS 2000 V-BC z szyną ślizgową | ✓ | ✓ | ✓ | | | | | 1100 | 80 | 180-15 | 15-0 | ✓ | ✓ | ✓ | ✓ | opcja ** |
| TS 2000 V-BC z ramieniem blokowanym | ✓ | | ✓ | ✓ | | ✓ | ✓ | 1250 | 100 | 180-15 | 15-0 | ✓ | | ✓ | ✓ | opcja ** |
| TS 2000 V-BC z ramieniem | ✓ | | ✓ | ✓ | | ✓ | ✓ | 1250 | 100 | 180-15 | 15-0 | ✓ | ✓ | ✓ | ✓ | opcja ** |
| TS 2000 V z szyną ślizgową | ✓ | ✓ | ✓ | | | | | 1100 | 80 | 180-15 | 15-0 | | ✓ | ✓ | ✓ | opcja ** |
| TS 2000 V z ramieniem blokowanym | ✓ | | ✓ | ✓ | | ✓ | ✓ | 1250 | 100 | 180-15 | 15-0 | | | ✓ | ✓ | opcja ** |
| TS 2000 V z ramieniem | ✓ | | ✓ | ✓ | | ✓ | ✓ | 1250 | 100 | 180-15 | 15-0 | | ✓ | ✓ | ✓ | opcja ** |
| TS 1500 V z ramieniem blokowanym | | ✓ | ✓ | | | ✓ | ✓ | 1100 | 80 | 180-15 | 15-0 | | | ✓ | ✓ | |
| TS 1500 V z ramieniem | | ✓ | ✓ | | | ✓ | ✓ | 1100 | 80 | 180-15 | 15-0 | | ✓ | ✓ | ✓ | |
| TS 1000 V z ramieniem blokowanym | ✓ | ✓ | ✓ | | | ✓ | ✓ | 1100 | 80 | 180-15 | 15-0 | | | ✓ | ✓ | |
| TS 1000 V z ramieniem | ✓ | ✓ | | | | ✓ | ✓ | 1100 | 80 | 180-15 | 15-0 | | ✓* | ✓ | ✓ | |

* niezalecany do drzwi przeciwpożarowych

** wymagana dodatkowa obejma



KOŁATKA CH TONDO

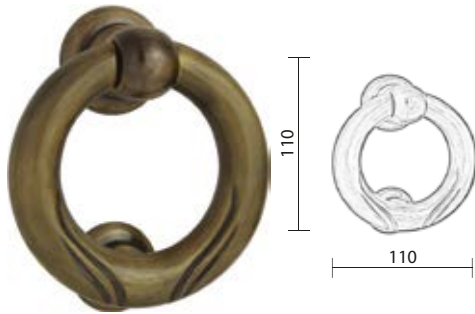

| | Netto | Brutto |
|----------------|--------------|--------|
| brąz grafiatto | 37,48 | 46,10 |
| czarny złoty | 41,06 | 50,50 |

KOŁATKA CH BAROCCO

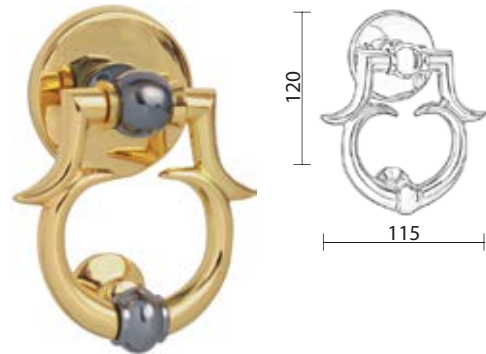

| | Netto | Brutto |
|--------------|--------------|--------|
| czarny złoty | 41,06 | 50,50 |

KOŁATKA VICTORIAN



mosiądz lakierowany

brąz grafiatto

chrom lakierowany

| | Netto | Brutto |
|---------------------|--------------|--------|
| mosiądz lakierowany | 45,77 | 56,30 |
| brąz grafiatto | 45,77 | 56,30 |
| chrom lakierowany | 56,75 | 69,80 |

ECOLINE K5



- cylinder mosiężny
- profil aluminiowy
- kolory: mosiądz satyna, nikiel satyna
- 5 kluczy w komplecie
- klucz płaski nawiercany



| | Z galką | | M9 | |
|--------|--------------|--------|--------------|--------|
| | M2 Netto | Brutto | Netto | Brutto |
| 31/31G | 19,76 | 24,30 | 19,76 | 24,30 |
| 31/41G | 22,36 | 27,50 | 22,36 | 27,50 |
| 36/31G | 20,65 | 25,40 | 20,65 | 25,40 |
| 41/31G | 22,36 | 27,50 | 22,36 | 27,50 |

| | Dwustronna | | M9 | |
|-------|--------------|--------|--------------|--------|
| | M2 Netto | Brutto | Netto | Brutto |
| 26/36 | 14,55 | 17,90 | 14,55 | 17,90 |
| 31/31 | 15,45 | 19,00 | 15,45 | 19,00 |
| 31/36 | 15,45 | 19,00 | 15,45 | 19,00 |
| 31/41 | 18,86 | 23,20 | 18,86 | 23,20 |



WKŁADKI DMO

Dwustronna



| | M2 | | M3 | | M9 | |
|-------|-------|--------|-------|--------|-------|--------|
| | Netto | Brutto | Netto | Brutto | Netto | Brutto |
| 26/36 | 18,05 | 22,20 | 18,94 | 23,30 | 18,94 | 23,30 |
| 26/41 | 17,64 | 21,70 | 18,70 | 23,00 | 18,70 | 23,00 |
| 27/27 | - | - | 17,48 | 21,50 | 17,48 | 21,50 |
| 31/31 | 17,15 | 21,10 | 17,97 | 22,10 | 17,97 | 22,10 |
| 31/36 | 18,05 | 22,20 | 18,86 | 23,20 | 18,86 | 23,20 |
| 31/41 | 18,86 | 23,20 | 20,65 | 25,40 | 20,65 | 25,40 |
| 31/46 | 19,76 | 24,30 | 20,65 | 25,40 | 20,65 | 25,40 |
| 31/51 | 24,07 | 29,60 | 24,96 | 30,70 | 24,96 | 30,70 |
| 31/56 | 24,07 | 29,60 | 28,37 | 34,90 | 28,37 | 34,90 |
| 35/65 | 33,58 | 41,30 | 35,28 | 43,40 | 35,28 | 43,40 |
| 36/36 | 19,76 | 24,30 | 20,65 | 25,40 | 20,65 | 25,40 |
| 36/41 | 20,65 | 25,40 | 22,36 | 27,50 | 22,36 | 27,50 |
| 36/46 | 25,77 | 31,70 | 26,67 | 32,80 | 26,67 | 32,80 |
| 36/51 | 28,37 | 34,90 | 29,27 | 36,00 | 29,27 | 36,00 |
| 41/41 | 25,77 | 31,70 | 41,06 | 50,50 | 41,06 | 50,50 |
| 41/46 | 28,37 | 34,90 | 29,19 | 35,90 | 29,19 | 35,90 |
| 41/51 | 30,08 | 37,00 | 30,98 | 38,10 | 30,98 | 38,10 |
| 41/56 | 32,68 | 40,20 | 34,39 | 42,30 | 34,39 | 42,30 |
| 46/46 | 29,27 | 36,00 | 30,98 | 38,10 | 30,98 | 38,10 |
| 46/56 | 33,58 | 41,30 | 35,28 | 43,40 | 35,28 | 43,40 |

WKŁADKI DMO

Z galką





| | M2 | | M3 | | M9 | |
|--------|-------|--------|-------|--------|-------|--------|
| | Netto | Brutto | Netto | Brutto | Netto | Brutto |
| 26/36G | 27,56 | 33,90 | 29,19 | 35,90 | 29,19 | 35,90 |
| 26/41G | 27,56 | 33,90 | 28,37 | 34,90 | 28,37 | 34,90 |
| 31/31G | 28,37 | 34,90 | 30,08 | 37,00 | 30,08 | 37,00 |
| 31/36G | 30,08 | 37,00 | 30,98 | 38,10 | 30,98 | 38,10 |
| 31/41G | 30,08 | 37,00 | 31,87 | 39,20 | 31,87 | 39,20 |
| 31/46G | 30,98 | 38,10 | 32,68 | 40,20 | 32,68 | 40,20 |
| 31/51G | 33,58 | 41,30 | 34,39 | 42,30 | 34,39 | 42,30 |
| 31/56G | 33,58 | 41,30 | 35,28 | 43,40 | 35,28 | 43,40 |
| 36/31G | 30,08 | 37,00 | 30,98 | 38,10 | 30,98 | 38,10 |
| 36/36G | 30,98 | 38,10 | 31,87 | 39,20 | 31,87 | 39,20 |
| 36/41G | 31,87 | 39,20 | 33,58 | 41,30 | 33,58 | 41,30 |
| 36/46G | 33,58 | 41,30 | 36,10 | 44,40 | 36,10 | 44,40 |
| 36/51G | 35,28 | 43,40 | 36,99 | 45,50 | 36,99 | 45,50 |
| 41/31G | 30,08 | 37,00 | 31,87 | 39,20 | 31,87 | 39,20 |
| 41/36G | 31,87 | 39,20 | 33,58 | 41,30 | 33,58 | 41,30 |
| 41/41G | 33,58 | 41,30 | 34,39 | 42,30 | 34,39 | 42,30 |
| 41/46G | 35,28 | 43,40 | 36,99 | 45,50 | 36,99 | 45,50 |
| 41/51G | 35,28 | 43,40 | 36,99 | 45,50 | 36,99 | 45,50 |
| 41/56G | 39,51 | 48,60 | 40,41 | 49,70 | 40,41 | 49,70 |
| 46/31G | 30,98 | 38,10 | 32,68 | 40,20 | 32,68 | 40,20 |
| 46/36G | 33,58 | 41,30 | 36,10 | 44,40 | 36,10 | 44,40 |
| 46/41G | 35,28 | 43,40 | 36,99 | 45,50 | 36,99 | 45,50 |
| 46/46G | 36,10 | 44,40 | 36,99 | 45,50 | 36,99 | 45,50 |
| 46/56G | 41,30 | 50,80 | 43,01 | 52,90 | 43,01 | 52,90 |
| 51/31G | 33,58 | 41,30 | 34,39 | 42,30 | 34,39 | 42,30 |
| 51/36G | 35,28 | 43,40 | 36,99 | 45,50 | 36,99 | 45,50 |
| 51/41G | 35,28 | 43,40 | 36,99 | 45,50 | 36,99 | 45,50 |
| 56/31G | 33,58 | 41,30 | 35,28 | 43,40 | 35,28 | 43,40 |
| 56/41G | 39,51 | 48,60 | 40,41 | 49,70 | 40,41 | 49,70 |
| 56/46G | 41,30 | 50,80 | 43,01 | 52,90 | 43,01 | 52,90 |

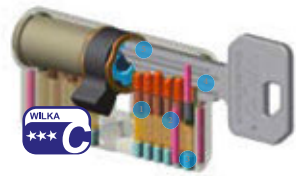

WKŁADKI BĘBENKOWE

3 klucze w komplecie



1. Stalowe i mosiężne kolki bębena i korpusu utwardzone powłoką niklową
2. Kolki grzybkowe jako zabezpieczenie „antypikowe”
3. Stalowe hartowane kolki w korpusie chroniące przed przewierceniem
4. Stalowe hartowane kolki w bębenu chroniące przed przewierceniem
5. Specjalny chroniony profil klucza

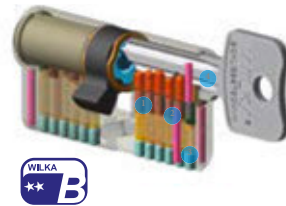

1. Stalowe i mosiężne kolki bębena i korpusu utwardzone powłoką niklową
2. Kolki grzybkowe jako zabezpieczenie „antypikowe”
3. Stalowe hartowane kolki w korpusie chroniące przed przewierceniem
4. Stalowe hartowane kolki w bębenu chroniące przed przewierceniem

WILKA
SCHLIESSTECHNIK



M1 M9

Czas realizacji do 3 tygodni

Doплата +15% do wkładek identycznie kodowanych

| Typ/ Wymiar | Dwustronna | | | |
|-------------|------------|--------|-------------|--------|
| | Klasa B | | ABHIII W235 | |
| | Netto | Brutto | Netto | Brutto |
| 1488 26/26 | 77,77 | 95,66 | 123,73 | 152,19 |
| 1481 26/30 | 77,77 | 95,66 | 123,73 | 152,19 |
| 1481 26/35 | 83,40 | 102,58 | 129,74 | 159,58 |
| 1481 26/40 | 89,08 | 109,57 | 135,80 | 167,03 |
| 1481 26/45 | 94,71 | 116,49 | 141,80 | 174,41 |
| 1481 26/50 | 100,36 | 123,44 | 147,82 | 181,82 |
| 1481 26/55 | 106,03 | 130,42 | 153,88 | 189,27 |
| Typ/ Wymiar | Klasa B | | Klasa C | |
| | Netto | Brutto | Netto | Brutto |
| | 1400 30/30 | 77,77 | 95,66 | 123,73 |
| 1400 30/35 | 83,40 | 102,58 | 129,74 | 159,58 |
| 1400 30/40 | 89,08 | 109,57 | 135,80 | 167,03 |
| 1400 30/45 | 94,71 | 116,49 | 141,80 | 174,41 |
| 1400 30/50 | 100,36 | 123,44 | 147,82 | 181,82 |
| 1400 30/55 | 106,03 | 130,42 | 153,88 | 189,27 |
| 1400 30/60 | 111,66 | 137,34 | 159,90 | 196,68 |
| 1400 30/65 | 117,29 | 144,27 | 165,90 | 204,06 |
| 1400 30/70* | 122,94 | 151,22 | 171,91 | 211,45 |
| 1400 30/75* | 231,57 | 284,83 | 310,94 | 382,46 |
| 1400 30/80* | 248,95 | 306,21 | 329,52 | 405,31 |
| 1400 35/35 | 89,08 | 109,57 | 135,80 | 167,03 |
| 1400 35/40 | 94,71 | 116,49 | 141,80 | 174,41 |
| 1400 35/45 | 100,36 | 123,44 | 147,82 | 181,82 |
| 1400 35/50 | 106,03 | 130,42 | 153,88 | 189,27 |
| 1400 35/55 | 111,66 | 137,34 | 159,90 | 196,68 |
| 1400 35/60 | 117,29 | 144,27 | 165,90 | 204,06 |
| 1400 35/65 | 122,94 | 151,22 | 171,91 | 211,45 |
| 1400 35/70* | 128,62 | 158,20 | 177,97 | 218,90 |
| 1400 35/75* | 248,95 | 306,21 | 329,52 | 405,31 |
| 1400 35/80* | 266,32 | 327,57 | 348,04 | 428,09 |
| 1400 35/85* | 283,69 | 348,94 | 366,57 | 450,88 |
| 1400 40/40 | 100,43 | 123,53 | 147,82 | 181,82 |
| 1400 40/45 | 106,03 | 130,42 | 153,88 | 189,27 |
| 1400 40/50 | 111,66 | 137,34 | 159,90 | 196,68 |
| 1400 40/55 | 117,29 | 144,27 | 165,90 | 204,06 |
| 1400 40/60 | 122,93 | 151,20 | 171,91 | 211,45 |
| 1400 40/65 | 128,62 | 158,20 | 177,97 | 218,90 |
| 1400 40/70* | 134,25 | 165,13 | 183,99 | 226,31 |
| 1400 40/75* | 266,31 | 327,56 | 348,04 | 428,09 |
| 1400 40/80* | 283,69 | 348,94 | 366,57 | 450,88 |
| 1400 40/90* | 318,47 | 391,72 | 403,63 | 496,46 |
| 1400 45/45 | 111,66 | 137,34 | 159,90 | 196,68 |
| 1400 45/50 | 117,29 | 144,27 | 165,90 | 204,06 |
| 1400 45/55 | 122,94 | 151,22 | 171,91 | 211,45 |
| 1400 45/60 | 128,62 | 158,20 | 177,97 | 218,90 |
| 1400 45/65 | 134,25 | 165,13 | 183,99 | 226,31 |
| 1400 45/70* | 151,62 | 186,49 | 202,51 | 249,09 |
| 1400 45/75* | 283,68 | 348,93 | 366,57 | 450,88 |
| 1400 50/50 | 122,94 | 151,22 | 171,91 | 211,45 |
| 1400 50/55 | 128,62 | 158,20 | 177,97 | 218,90 |
| 1400 50/60 | 134,25 | 165,13 | 183,99 | 226,31 |
| 1400 50/65 | 151,62 | 186,49 | 202,51 | 249,09 |
| 1400 50/70* | 168,99 | 207,86 | 221,04 | 271,88 |
| 1400 50/75* | 301,10 | 370,35 | 385,10 | 473,67 |
| 1400 55/55 | 134,25 | 165,13 | 183,99 | 226,31 |
| 1400 55/60 | 151,62 | 186,49 | 202,51 | 249,09 |
| 1400 55/65 | 168,99 | 207,86 | 221,04 | 271,88 |
| 1400 55/70* | 186,40 | 229,27 | 239,61 | 294,72 |
| 1400 55/75* | 207,00 | 254,61 | 403,62 | 496,45 |
| 1400 60/60* | 168,99 | 207,86 | 221,04 | 271,88 |
| 1400 60/65* | 186,40 | 229,27 | 239,61 | 294,72 |
| 1400 65/70* | 221,14 | 272,00 | 276,67 | 340,30 |

| Typ/ Wymiar | Z galką | | | |
|-------------|------------|--------|-------------|--------|
| | Klasa B | | ABHIII W235 | |
| | Netto | Brutto | Netto | Brutto |
| 1407 26/26 | 95,14 | 117,02 | 144,14 | 177,29 |
| 1484 26/30 | 95,14 | 117,02 | 144,14 | 177,29 |
| 1484 26/35 | 100,82 | 124,01 | 150,16 | 184,70 |
| 1484 26/40 | 106,45 | 130,93 | 156,17 | 192,09 |
| 1484 26/45 | 112,08 | 137,86 | 162,22 | 199,53 |
| 1484 26/50 | 117,73 | 144,81 | 168,23 | 206,92 |
| 1484 26/55 | 123,40 | 151,78 | 174,25 | 214,33 |
| Typ/ Wymiar | Klasa B | | Klasa C | |
| | Netto | Brutto | Netto | Brutto |
| | 1405 30/30 | 95,14 | 117,02 | 144,14 |
| 1405 30/35 | 100,82 | 124,01 | 150,16 | 184,70 |
| 1405 30/40 | 107,76 | 132,54 | 156,17 | 192,09 |
| 1405 30/45 | 112,08 | 137,86 | 162,22 | 199,53 |
| 1405 30/50 | 117,73 | 144,81 | 168,23 | 206,92 |
| 1405 30/55 | 123,40 | 151,78 | 174,25 | 214,33 |
| 1405 30/60 | 129,03 | 158,71 | 180,25 | 221,71 |
| 1405 30/65 | 134,66 | 165,63 | 186,31 | 229,16 |
| 1405 30/70* | 140,36 | 172,64 | 192,33 | 236,57 |
| 1405 30/75* | 248,95 | 306,21 | 331,35 | 407,56 |
| 1405 35/35 | 106,45 | 130,93 | 156,17 | 192,09 |
| 1405 35/40 | 112,08 | 137,86 | 162,22 | 199,53 |
| 1405 35/45 | 117,73 | 144,81 | 168,23 | 206,92 |
| 1405 35/50 | 123,40 | 151,78 | 174,25 | 214,33 |
| 1405 35/55 | 129,03 | 158,71 | 180,25 | 221,71 |
| 1405 35/60 | 134,66 | 165,63 | 186,31 | 229,16 |
| 1405 35/65 | 140,36 | 172,64 | 192,33 | 236,57 |
| 1405 35/70* | 145,99 | 179,57 | 198,34 | 243,96 |
| 1405 35/75* | 266,32 | 327,57 | 349,88 | 430,35 |
| 1405 40/40 | 117,73 | 144,81 | 168,23 | 206,92 |
| 1405 40/45 | 123,40 | 151,78 | 174,25 | 214,33 |
| 1405 40/50 | 129,03 | 158,71 | 180,25 | 221,71 |
| 1405 40/55 | 134,66 | 165,63 | 186,31 | 229,16 |
| 1405 40/60 | 140,36 | 172,64 | 192,33 | 236,57 |
| 1405 40/65 | 145,99 | 179,57 | 198,34 | 243,96 |
| 1405 40/70* | 151,62 | 186,49 | 204,39 | 251,40 |
| 1405 40/75* | 283,69 | 348,94 | 368,41 | 453,14 |
| 1405 45/45 | 129,03 | 158,71 | 180,25 | 221,71 |
| 1405 45/50 | 134,66 | 165,63 | 186,31 | 229,16 |
| 1405 45/55 | 140,36 | 172,64 | 192,33 | 236,57 |
| 1405 45/60 | 145,99 | 179,57 | 198,34 | 243,96 |
| 1405 45/65 | 151,62 | 186,49 | 204,39 | 251,40 |
| 1405 45/70* | 168,99 | 207,86 | 222,93 | 274,20 |
| 1405 45/75* | 301,10 | 370,35 | 386,98 | 475,99 |
| 1405 50/50 | 140,36 | 172,64 | 192,33 | 236,57 |
| 1405 50/55 | 145,99 | 179,57 | 198,34 | 243,96 |
| 1405 50/60 | 151,62 | 186,49 | 204,39 | 251,40 |
| 1405 50/65 | 168,99 | 207,86 | 222,93 | 274,20 |
| 1405 50/70* | 186,40 | 229,27 | 241,45 | 296,98 |
| 1405 50/75* | 318,47 | 391,72 | 405,51 | 498,78 |
| 1405 55/55 | 151,62 | 186,49 | 204,39 | 251,40 |
| 1405 55/60 | 168,99 | 207,86 | 222,93 | 274,20 |
| 1405 55/65 | 186,40 | 229,27 | 241,45 | 296,98 |
| 1405 55/70* | 203,77 | 250,64 | 259,99 | 319,79 |
| 1405 55/75* | 335,84 | 413,08 | 424,04 | 521,57 |
| 1405 60/60* | 186,40 | 229,27 | 241,45 | 296,98 |
| 1405 60/65* | 203,77 | 250,64 | 259,98 | 319,78 |
| 1405 65/70* | 238,51 | 293,37 | 297,08 | 365,41 |



WKŁADKI BĘBENKOWE

6 kluczy w komplecie

Jeden klucz zamiast pęku kluczy

Identyczne kodowanie zamknięć to rozwiązanie, które pozwala na otwieranie wszystkich wkładek, kłódek, zamków za pomocą jednego klucza. Sprawdza się ono w domu, sklepie lub magazynie i daje możliwość otwierania jednym kluczem wszystkich drzwi, bram, furtek lub skrzynek.

Wyższy poziom zabezpieczenia obiektu

W zależności od wymagań, w ramach identycznego kodowania, można zamówić wkładki atestowane w różnych klasach zabezpieczenia - A, B, C, C Premium.

Uwaga

Komplet zawiera wkładkę dwustornną + wkładkę z galką.

Brak możliwości kodowania dodatkowych wkładek do zestawu.

Czas realizacji do 3 tygodni



Komplet wkładek standard



Satyna



Mosiądz

Typ/ Wymiar

1484 26/35 + 1481 26/35
1484 26/40 + 1481 26/40
1484 26/45 + 1481 26/45
1484 26/50 + 1481 26/50
1484 26/55 + 1481 26/55

1405 30/30 + 1400 30/30
1405 30/35 + 1400 30/35
1405 30/40 + 1400 30/40
1405 30/45 + 1400 30/45
1405 30/50 + 1400 30/50
1405 30/55 + 1400 30/55
1405 30/60 + 1400 30/60
1405 30/65 + 1400 30/65
1405 30/70 + 1400 30/70
1405 35/35 + 1400 35/35
1405 35/40 + 1400 35/40
1405 35/45 + 1400 35/45
1405 35/50 + 1400 35/50
1405 35/55 + 1400 35/55
1405 35/60 + 1400 35/60
1405 35/65 + 1400 35/65
1405 35/70 + 1400 35/70
1405 40/40 + 1400 40/40
1405 40/45 + 1400 40/45
1405 40/50 + 1400 40/50
1405 40/55 + 1400 40/55
1405 40/60 + 1400 40/60
1405 40/65 + 1400 40/65
1405 40/70 + 1400 40/70
1405 45/45 + 1400 45/45
1405 45/50 + 1400 45/50
1405 45/55 + 1400 45/55
1405 45/60 + 1400 45/60
1405 45/65 + 1400 45/65
1405 45/70 + 1400 45/70
1405 50/50 + 1400 50/50
1405 50/55 + 1400 50/55
1405 50/60 + 1400 50/60
1405 50/65 + 1400 50/65
1405 55/55 + 1400 55/55
1405 55/60 + 1400 55/60
1405 55/65 + 1400 55/65
1405 60/60 + 1400 60/60
1405 60/65 + 1400 60/65

Wkładki bębnekowe z galką

Klasa B S150

ABHIII W235

| Netto | Brutto | Netto | Brutto |
|--------|--------|-----------|--------|
| 157,52 | 193,75 | 94,07 zł | 115,71 |
| 166,82 | 205,19 | 98,06 zł | 120,61 |
| 176,15 | 216,66 | 102,06 zł | 125,53 |
| 185,47 | 228,13 | 106,05 zł | 130,44 |
| 194,78 | 239,58 | 110,06 zł | 135,37 |

Klasa B S150

Klasa C W235

| Netto | Brutto | Netto | Brutto |
|--------|--------|--------|--------|
| 148,19 | 182,28 | 187,05 | 230,07 |
| 157,52 | 193,75 | 195,38 | 240,32 |
| 166,82 | 205,19 | 203,67 | 250,51 |
| 176,15 | 216,66 | 211,98 | 260,73 |
| 185,47 | 228,13 | 220,26 | 270,92 |
| 194,78 | 239,58 | 228,59 | 281,17 |
| 204,10 | 251,05 | 236,88 | 291,36 |
| 213,41 | 262,49 | 245,19 | 301,58 |
| 222,73 | 273,96 | 253,49 | 311,80 |
| 166,82 | 205,19 | 203,67 | 250,51 |
| 176,15 | 216,66 | 211,98 | 260,73 |
| 185,47 | 228,13 | 220,26 | 270,92 |
| 194,78 | 239,58 | 228,59 | 281,17 |
| 204,10 | 251,05 | 236,88 | 291,36 |
| 213,41 | 262,49 | 245,19 | 301,58 |
| 222,73 | 273,96 | 253,49 | 311,80 |
| 232,06 | 285,43 | 261,80 | 322,02 |
| 185,47 | 228,13 | 220,26 | 270,92 |
| 194,78 | 239,58 | 228,59 | 281,17 |
| 204,10 | 251,05 | 236,88 | 291,36 |
| 213,41 | 262,49 | 245,19 | 301,58 |
| 222,73 | 273,96 | 253,49 | 311,80 |
| 232,06 | 285,43 | 261,80 | 322,02 |
| 241,39 | 296,90 | 270,09 | 332,21 |
| 204,10 | 251,05 | 236,88 | 291,36 |
| 213,41 | 262,49 | 245,19 | 301,58 |
| 222,73 | 273,96 | 253,49 | 311,80 |
| 232,06 | 285,43 | 261,80 | 322,02 |
| 241,39 | 296,90 | 270,09 | 332,21 |
| 267,99 | 329,63 | 293,83 | 361,41 |
| 222,73 | 273,96 | 253,49 | 311,80 |
| 232,06 | 285,43 | 261,80 | 322,02 |
| 241,39 | 296,90 | 270,09 | 332,21 |
| 267,99 | 329,63 | 293,83 | 361,41 |
| 241,39 | 296,90 | 270,09 | 332,21 |
| 267,99 | 329,63 | 293,83 | 361,41 |
| 294,62 | 362,38 | 317,57 | 390,61 |
| 294,62 | 362,38 | 317,57 | 390,61 |
| 321,24 | 395,13 | 341,29 | 419,78 |

Systemy Master Key na indywidualne zamówienie



+15%

z ceny typu z wariantem



MECHATRONICZNA WKŁADKA DWUGAŁKOWA E204

WILKA
SCHLIESSTECHNIK



M9

- wkładka bębnowa dwugałkowa z kontrolą dostępu od strony zewnętrznej
- programowanie wkładki za pomocą programu komputerowego E850
- system niezależny, zasilany bateriami
- możliwość łączenia z mechanicznymi systemami Master Key typu STR; TH6; 3VE
- współpracuje w wyrobami wykonanymi w technologii Mifare
- zabezpieczenie przed przewierceniem
- wkładka zawiera 1 baterię alkaliczną, które wystarcza na max. 80.000 cykli
- gałki wkładki wykonane ze stali nierdzewnej i tworzywa
- gałka wewnętrzna – średnica 36 mm, długość 24 mm
- gałka zewnętrzna – średnica 36 mm, długość 48 mm
- długość standardowa 30/30mm
- możliwość przedłużania o 5mm w obie strony do rozmiaru 90/90mm (za dopłatą)
- wykończenie powierzchni nikiel matowy

| Typ/ Wymiar | Cena zestawu | |
|-------------|--------------------|-------------|
| | Netto | Brutto |
| E204 30/40 | 2 171,34 zł | 2 670,75 zł |
| E204 30/45 | 2 260,60 zł | 2 780,54 zł |
| E204 40/50 | 2 349,78 zł | 2 890,22 zł |
| E204 40/55 | 2 438,93 zł | 2 999,89 zł |
| E204 45/50 | 2 438,93 zł | 2 999,89 zł |
| E204 45/55 | 2 528,56 zł | 3 110,13 zł |



Zestaw zawiera:

Wkładka mechatroniczna Gałka+Gałka

Klucz serwisowy (do wymiany baterii)

Karta programująca 1 szt

Karta użytkownika 6 szt (bez nadruku)



Karta programująca



Karta użytkownika



ZATRZASKOWA MOSIĄDZ



| | Netto | Brutto |
|-----------|--------------|--------|
| 30-90U141 | 6,34 | 7,80 |
| 40-90U142 | 8,21 | 10,10 |
| 50-90U143 | 13,74 | 16,90 |
| 60-90U144 | 18,29 | 22,50 |

HOMER



| | Netto | Brutto |
|------|--------------|--------|
| KZ38 | 9,19 | 11,30 |
| KZ45 | 11,54 | 14,20 |
| KZ52 | 14,47 | 17,80 |
| KZ63 | 17,40 | 21,40 |

ŻELIWNA



| | Netto | Brutto |
|-----|--------------|--------|
| H40 | 7,24 | 8,90 |
| H50 | 10,65 | 13,10 |
| H60 | 14,80 | 18,20 |

B-88 L



| | Netto | Brutto |
|-------------|--------------|--------|
| B-88 L 63mm | 15,53 | 19,10 |

LS



| | Netto | Brutto |
|--------|--------------|--------|
| LS R50 | 45,53 | 56,00 |
| LS R60 | 53,58 | 65,90 |

SFX



| | Netto | Brutto |
|---------|--------------|--------|
| SFX R50 | 15,12 | 18,60 |



WZMOCNIONA

HOMER
 JESTES U SIEBIE

| | Netto | Brutto |
|------|--------------|--------|
| BH30 | 13,98 | 17,20 |
| BH40 | 23,25 | 28,60 |
| BH50 | 29,84 | 36,70 |
| BH60 | 38,78 | 47,70 |

WZMOCNIONA
LONG
HOMER
 JESTES U SIEBIE

| | Netto | Brutto |
|-------|--------------|--------|
| BH40L | 24,31 | 29,90 |
| BH60L | 41,38 | 50,90 |

ZATRZASKOWA

HOMER
 JESTES U SIEBIE

| | Netto | Brutto |
|-----|--------------|--------|
| S40 | 17,24 | 21,20 |
| S50 | 27,56 | 33,90 |
| S60 | 41,38 | 50,90 |

SZYFROWA

HOMER
 JESTES U SIEBIE

| | Netto | Brutto |
|--|--------------|--------|
| | 12,44 | 15,30 |

TRZPIENIOWA

HOMER
 JESTES U SIEBIE

| | Netto | Brutto |
|------|--------------|--------|
| BX50 | 26,42 | 32,50 |
| BX70 | 45,20 | 55,60 |

Y121

Yale

| | Netto | Brutto |
|---------|--------------|--------|
| Y121/40 | 52,20 | 64,20 |
| Y121/50 | 70,00 | 86,10 |



YE3



■
zielony

| | Netto | Brutto |
|-------|--------------|--------|
| 25 mm | 14,96 | 18,40 |
| 32 mm | 19,35 | 23,80 |
| 38 mm | 24,23 | 29,80 |

YE3 LONG



■
zielony

| | Netto | Brutto |
|-------|--------------|--------|
| 38 mm | 24,72 | 30,40 |

YP2/23/128/1



■
czerwony

■
srebrny

■
żółty

| | Netto | Brutto |
|--|--------------|--------|
| | 23,98 | 29,50 |

Y150



| | Netto | Brutto |
|---------|--------------|--------|
| Y150/22 | 23,50 | 28,90 |
| Y150/30 | 28,94 | 35,60 |
| Y150/40 | 38,62 | 47,50 |

Y110J/15/111/4



| | Netto | Brutto |
|--|--------------|--------|
| | 52,76 | 64,90 |



17K

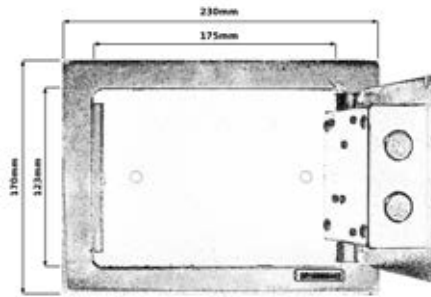

| | Netto | Brutto |
|----------------|--------|--------|
| 170x230x170 mm | 138,46 | 170,30 |

CH-20 ER

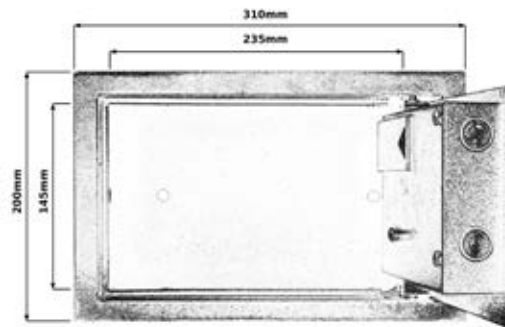

| | Netto | Brutto |
|----------------|--------|--------|
| 200x310x200 mm | 157,40 | 193,60 |

BH-23 ER

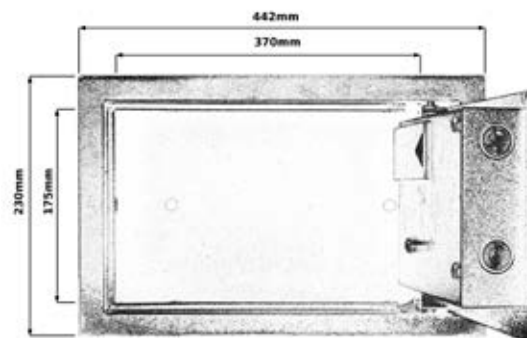

| | Netto | Brutto |
|----------------|--------|--------|
| 230x442x380 mm | 347,07 | 426,90 |



LISTWA USZCZELNIAJĄCA ZE SZCZOTKĄ 1 MB

Samoprzylepna

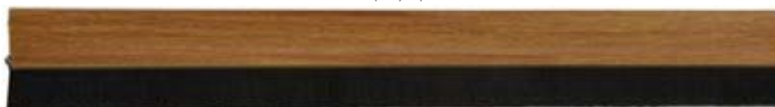

| | biały, brąz | | dąb, sosna | |
|-------|--------------|--------|--------------|--------|
| | Netto | Brutto | Netto | Brutto |
| 14 mm | 15,12 | 18,60 | 19,59 | 24,10 |
| 24 mm | 16,91 | 20,80 | 20,49 | 25,20 |

| | Netto | Brutto |
|-------|--------------|--------|
| 14 mm | 16,91 | 20,80 |
| 24 mm | 18,13 | 22,30 |
| 34 mm | 18,70 | 23,00 |

LISTWA USZCZELNIAJĄCA ZE SZCZOTKĄ

Kątowa aluminiowa 1 mb



| | Netto | Brutto |
|-------|--------------|--------|
| 14 mm | 18,70 | 23,00 |
| 24 mm | 20,49 | 25,20 |
| 34 mm | 21,38 | 26,30 |

LISTWA OPADAJĄCA

Z podporą



| | Netto | Brutto |
|---------|--------------|--------|
| 830 mm | 78,37 | 96,40 |
| 930 mm | 80,00 | 98,40 |
| 1030 mm | 81,63 | 100,40 |

Bez podpory



| | Netto | Brutto |
|---------|--------------|--------|
| 830 mm | 75,93 | 93,40 |
| 930 mm | 77,56 | 95,40 |
| 1030 mm | 78,37 | 96,40 |



W0713



| | | |
|---------------|--------------|--------------|
| | M6 | M9 |
| Netto | 19,43 | 16,75 |
| Brutto | 23,90 | 20,60 |

W0714



| | | |
|---------------|--------------|--------------|
| | M6 | M9 |
| Netto | 25,61 | 25,61 |
| Brutto | 31,50 | 31,50 |

W0715



| | | |
|---------------|--------------|--------------|
| | M6 | M9 |
| Netto | 24,72 | 29,19 |
| Brutto | 30,40 | 35,90 |

W0718



| | | |
|---------------|--------------|--------------|
| | M6 | M9 |
| Netto | 25,61 | 30,89 |
| Brutto | 31,50 | 38,00 |

W0722



| | | |
|---------------|--------------|--------------|
| | M6 | M9 |
| Netto | 25,61 | 29,19 |
| Brutto | 31,50 | 35,90 |

W0728



| | | |
|---------------|--------------|--------------|
| | M6 | M9 |
| Netto | 39,84 | 43,33 |
| Brutto | 49,00 | 53,30 |

W0729



| | | |
|---------------|--------------|--------------|
| | M6 | M9 |
| Netto | 30,00 | 24,72 |
| Brutto | 36,90 | 30,40 |

W5028



| | |
|---------------|--------------|
| Netto | 16,75 |
| Brutto | 20,60 |

W5030



| | |
|---------------|--------------|
| Netto | 16,75 |
| Brutto | 20,60 |



W102







M3

Netto **4,31**
Brutto **5,30**

Z5573





M3 M6 M9

Netto **9,67**
Brutto **11,90**

W0808







M6

Netto **14,96**
Brutto **18,40**

WHZB06







M3 M6 M9

Netto **4,47**
Brutto **5,50**

W011







M3 M6 M9

Netto **8,29**
Brutto **10,20**

WHZB01







M3 M6 M9

Netto **2,68**
Brutto **3,30**

 WHZB02







M3 M6 M9

Netto **5,45**
Brutto **6,70**

WHZB04







M3 M6 M9

Netto **3,58**
Brutto **4,40**

WHZB06





M3 M6 M9

Netto **4,47**
Brutto **5,50**



WHZB44

 domino®



czarny

Netto

| |
|------|
| 9,11 |
|------|

Brutto

| |
|-------|
| 11,20 |
|-------|

WHZB07

 domino®



czarny

Netto

| |
|------|
| 2,28 |
|------|

Brutto

| |
|------|
| 2,80 |
|------|

WHZB11

 domino®
nowość



F1

Netto

| |
|------|
| 4,47 |
|------|

Brutto

| |
|------|
| 5,50 |
|------|

W0730

 domino®



M6 M8

Netto

| |
|-------|
| 16,75 |
|-------|

Brutto

| |
|-------|
| 20,60 |
|-------|

PORCELANA

 domino®



biały czarny czerwony retro

Netto

| |
|-------|
| 14,96 |
|-------|

Brutto

| |
|-------|
| 18,40 |
|-------|

RÓŻA

 domino®



M75

Netto

| |
|------|
| 4,15 |
|------|

Brutto

| |
|------|
| 5,10 |
|------|

W079H



M91/M6

M91/M6
Netto

| |
|-------|
| 35,35 |
|-------|

Brutto

| |
|-------|
| 43,50 |
|-------|

COMFORT

biały



Netto

| |
|-------|
| 48,62 |
|-------|

Brutto

| |
|-------|
| 59,80 |
|-------|

390x140x45

POPULAR

 domino®



biały

Netto

| |
|-------|
| 48,62 |
|-------|

Brutto

| |
|-------|
| 59,80 |
|-------|

400x150x47



CLASSIC



naturalny



| | Netto | Brutto |
|------------|--------------|--------|
| 450x130x88 | 61,95 | 76,20 |

MODERN



naturalny



| | Netto | Brutto |
|-----------|--------------|--------|
| 450x68x60 | 61,95 | 76,20 |

YJ4036



mix



| | Netto | Brutto |
|-----------|--------------|--------|
| 177x39x80 | 77,89 | 95,80 |



SKRZYŃKA WP009

Na listy



| | Netto | Brutto |
|----------------|---------------|--------|
| 350x130x425 mm | 257,48 | 316,70 |

SKRZYŃKA WP011

Na listy



| | Netto | Brutto |
|----------------|---------------|--------|
| 332x116x425 mm | 134,88 | 165,90 |

SKRZYŃKA WP013

Na listy



| | Netto | Brutto |
|----------------|---------------|--------|
| 352x140x352 mm | 234,07 | 287,90 |

SKRZYŃKA WPM34G

Na listy



| | Netto | Brutto |
|----------------|---------------|--------|
| 410x136x355 mm | 126,91 | 156,10 |

SKRZYŃKA WPM30G

Na listy



| | Netto | Brutto |
|----------------|---------------|--------|
| 290x130x420 mm | 185,93 | 228,70 |

SKRZYŃKA WP014

Na listy



| | Netto | Brutto |
|----------------|---------------|--------|
| 280x136x327 mm | 164,47 | 202,30 |



SKRZYŃKA HPB1402

Na listy



| | Netto | Brutto |
|----------------|---------------|--------|
| 380x330x110 mm | 143,01 | 175,90 |

SKRZYŃKA HPB2210

Na listy



| | Netto | Brutto |
|---------------|---------------|--------|
| 300x340x90 mm | 119,75 | 147,30 |

SKRZYŃKA HPB2211

Na listy



| | Netto | Brutto |
|----------------|---------------|--------|
| 300x400x120 mm | 133,17 | 163,80 |

SKRZYŃKA HPB918 N

Na listy



| | Netto | Brutto |
|----------------|---------------|--------|
| 350x320x110 mm | 133,17 | 163,80 |

**APTECZKA
ŚCIENNA**

| | Netto | Brutto |
|----------------|--------------|--------|
| 300x248x110 mm | 89,27 | 109,80 |

**SKRZYŃKA
HYBRYDA**

Na listy



| | Netto | Brutto |
|---------------|--------------|--------|
| 180x60x250 mm | 28,54 | 35,10 |

**SKRZYŃKI
NA KLUCZE**

| | Netto | Brutto |
|---------------------------|--------------|--------|
| 20 kluczy 200x150x80 mm | 46,18 | 56,80 |
| 48 kluczy 300x240x80 mm | 55,37 | 68,10 |
| 96 kluczy 250x180x80 mm | 91,54 | 112,60 |



TYP-1 / 2 / 4 / 5

Ścienny

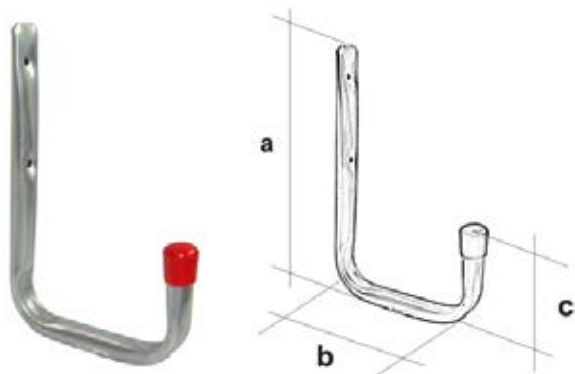

| | a | b | c |
|-------|-----|-----|----|
| TYP-1 | 215 | 149 | 90 |
| TYP-2 | 270 | 288 | 92 |
| TYP-4 | 132 | 85 | 50 |
| TYP-5 | 144 | 117 | 52 |

| | Netto | Brutto |
|--------------------|-------------|--------|
| D/05 TYP-5 ścienny | 4,15 | 5,10 |
| D/04 TYP-4 ścienny | 4,15 | 5,10 |
| D/02 TYP-2 ścienny | 7,56 | 9,30 |
| D/01 TYP-1 ścienny | 5,85 | 7,20 |

TYP-3

Sufitowy

**TYP-6**

Sufitowy

**TYPE-9**

Na rowery

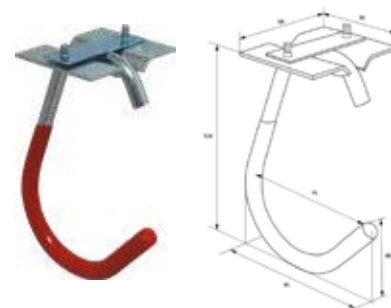
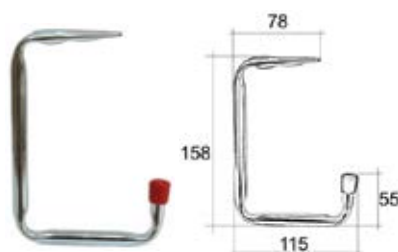

| | Netto | Brutto |
|---------------------|--------------|--------|
| D/03 TYP-3 sufitowy | 24,63 | 30,30 |

| | Netto | Brutto |
|---------------------|-------------|--------|
| D/06 TYP-6 sufitowy | 5,85 | 7,20 |

| | Netto | Brutto |
|----------------------|-------------|--------|
| D/09 TYP-9 na rowery | 6,75 | 8,30 |

TYP-13

Ścienno-sufitowy

**TYP-15**

Uniwersalny

**TYP-19**

Na felgi

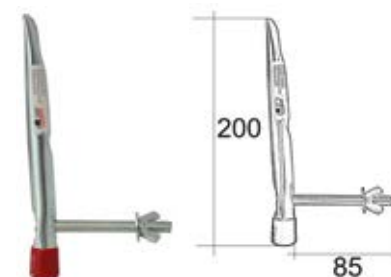
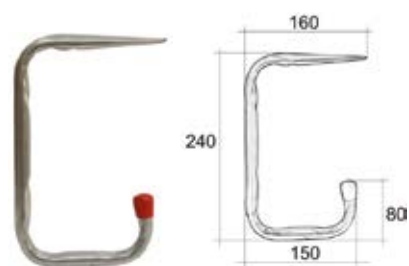

| | Netto | Brutto |
|------------------------------|--------------|--------|
| D/13 TYP-13 ścienno-sufitowy | 10,16 | 12,50 |

| | Netto | Brutto |
|-------------------------|--------------|--------|
| D/15 TYP-15 uniwersalny | 26,42 | 32,50 |

| | Netto | Brutto |
|----------------------|--------------|--------|
| D/19 TYP-19 na felgi | 14,47 | 17,80 |



TYP-27 / 28 / 29 / 30

Prosty podwójny

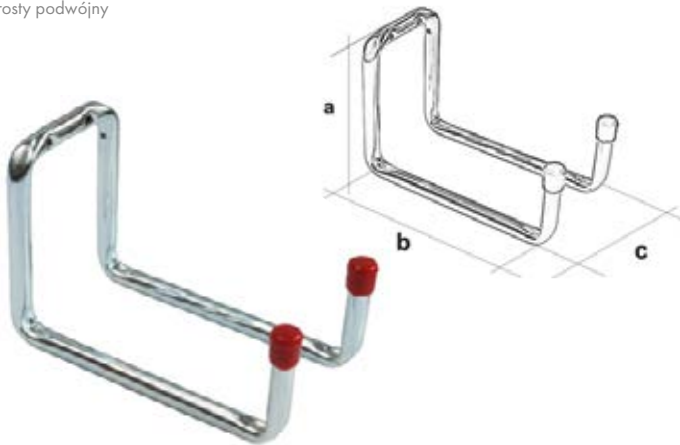

| | a | b | c |
|--------|-----|-----|----|
| TYP-27 | 120 | 75 | 90 |
| TYP-28 | 117 | 170 | 90 |
| TYP-29 | 117 | 246 | 90 |
| TYP-30 | 120 | 320 | 90 |

| | Netto | Brutto |
|----------------------|--------------|--------|
| D/30 TYP-30 podwójny | 14,47 | 17,80 |
| D/29 TYP-29 podwójny | 12,68 | 15,60 |
| D/28 TYP-28 podwójny | 10,98 | 13,50 |
| D/27 TYP-27 podwójny | 10,98 | 13,50 |

TYP-33

Na rowery

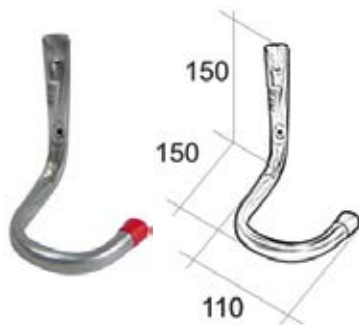

| | Netto | Brutto |
|-----------------------|-------------|--------|
| D/33 TYP-33 na rowery | 9,27 | 11,40 |

TYP-34

Podwójny prosty

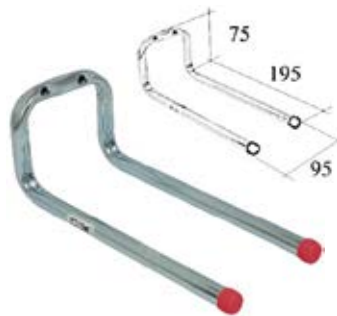

| | Netto | Brutto |
|-----------------------------|-------------|--------|
| D/34 TYP-34 podwójny prosty | 7,56 | 9,30 |

TYP-37

Na deskę windsurfing

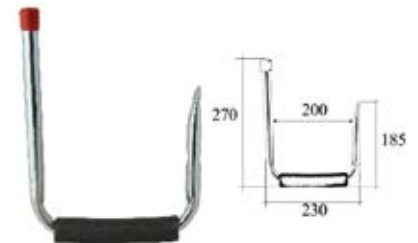

| | Netto | Brutto |
|----------------------------------|--------------|--------|
| D/37 TYP-37 na deskę windsurfing | 13,58 | 16,70 |

TYP-40

Na narty



| | Netto | Brutto |
|----------------------|--------------|--------|
| D/40 TYP-40 na narty | 16,91 | 20,80 |

TYP-41 / 42

Na skrzynkę

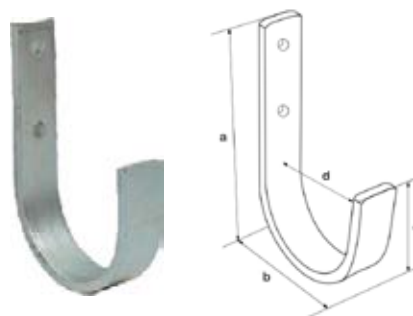

| | a | b | c | d |
|--------|-----|----|----|----|
| TYP-41 | 115 | 70 | 50 | 60 |
| TYP-42 | 92 | 45 | 30 | 35 |

| | Netto | Brutto |
|-------------------------|-------------|--------|
| D/42 TYP-42 na skrzynkę | 6,75 | 8,30 |
| D/41 TYP-41 na skrzynkę | 6,75 | 8,30 |



SZAFA S 01



SZAFA AKCESORIA



SZAFA S 03



SZAFA S 02



PLANET PREMIUM



PLANET S3



PLANET





FORMY PRZEBIĆ

BB



Otwór na klucz

PZ



Otwór na wkładkę
bębenkową

WC



WC blokada

B/O

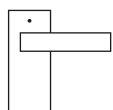

Bez otworu

DZIELONA

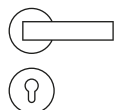

Klamka dzielona

OKIENNA



Klamka okienna

KOMBINACJE

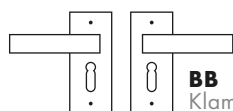

BB
Klamka/
Klamka na klucz

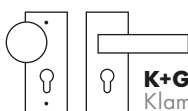

K+G ZEW PZ P
Klamka/
Gałka zewnętrzna
PZ prawa

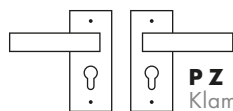

PZ
Klamka/
Klamka na wkładkę
bębenkowa

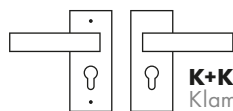

K+K ZEW PZ P
Klamka/
Klamka zewnętrzna
PZ prawa

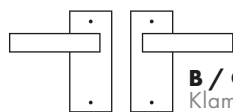

B/O
Klamka/
Klamka bez otworu

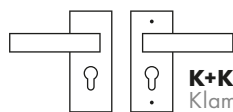

K+K ZEW PZ L
Klamka/
Klamka zewnętrzna
PZ lewa

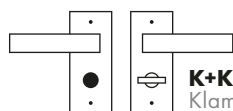

K+K WC P
Klamka/
Klamka blokada WC
prawa

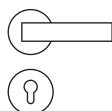

- R
Klamka dzielona
na rozecie
okrągłej

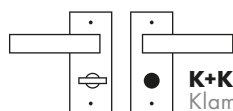

K+K WC L
Klamka/
Klamka blokada WC
lewa

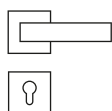

- QR
Klamka dzielona
na rozecie
kwadratowej

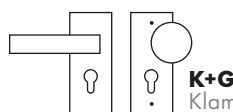

K+G ZEW PZ L
Klamka/
Gałka zewnętrzna
PZ lewa

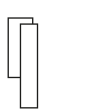

- QR
Klamka
okienna

KOLORY

| | | |
|--------|--|------------------------------------|
| M1 | | Mosiądz lakierowany |
| M2 | | Mosiądz satynowany |
| M3 | | Brąz grafiatto |
| M3 mat | | Brąz mat |
| M4 | | Chrom satynowany |
| M6 | | Chrom lakierowany |
| M7 | | Chrom perłowy |
| M8 | | Tytan |
| M9 | | Nikiel lakierowany |
| M10 | | Brąz złoty |
| M91 | | Nikiel satyna velvet |
| M95 | | Nikiel antyczny |
| M18 | | Chrom satynowany nielakierowany |
| M50 | | Chrom satyna |
| M75 | | Brąz antyk |
| INX | | Stal nierdzewna |
| SN | | Nikiel satynowany |
| F1 | | Srebrny mat anodowany |
| F2 | | Szampański mat anodowany |
| F3 | | Złoty mat anodowany |
| F4 | | Brąz mat anodowany |
| F6 INX | | Stal nierdzewna |
| F9 | | Tytan anodowany |
| | | Czarny |

ŁĄCZENIA KOLORÓW

| | |
|-------------|--|
| M1/M2 | Mosiądz lakierowany/mosiądz satyna |
| M50/M6 | Chrom satyna/chrom lakierowany |
| M6/M18 | Chrom lakierowany/chrom satynowany nielakierowany |
| M6/M9 | Chrom lakierowany/nikiel lakierowany |
| M6/M50 | Chrom lakierowany/chrom satyna |
| M7/M9 | Chrom perłowy/nikiel lakierowany |
| M6/white | Chrom lakierowany/biały |
| M6/antracyt | Chrom lakierowany/antracyt |

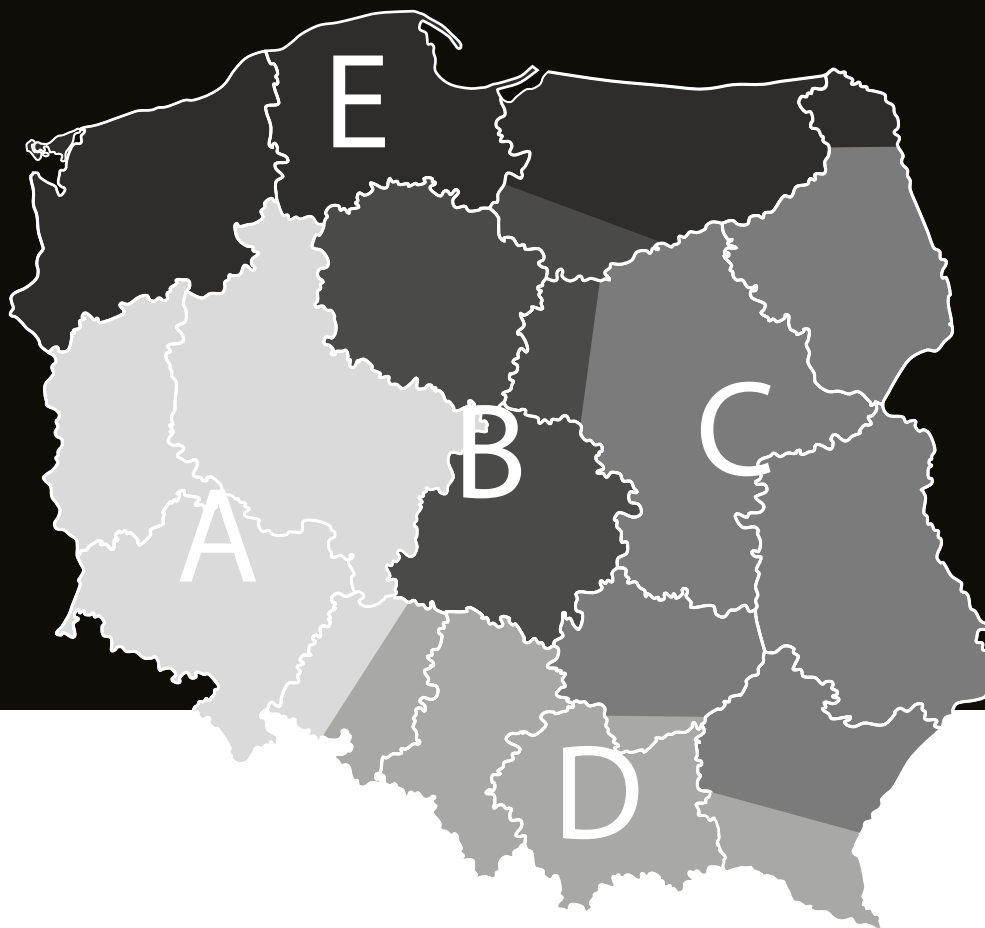

REGION A

d.nowacki@domino.pl

+48 601 770 498

+48 74 667 04 12

REGION B

r.zajac@domino.pl

+48 609 830 644

+48 74 832 32 52

REGION C

j.lysiak@domino.pl

+48 605 256 868

+48 74 667 04 16

REGION D

l.pawlaszczyk@domino.pl

+48 603 508 923

+48 74 832 48 07

REGION E

s.sas@domino.pl

+48 601 141 556

+48 74 832 10 11

DOMINO POLSKA

SPÓŁKA Z OGRANICZONĄ
ODPOWIEDZIALNOŚCIĄ
SPÓŁKA KOMANDYTOWA

ul. Rzeźnicza 4

58-200 Dzierżoniów

tel. +48 74 832 32 37

fax +48 74 660 79 78

hurt@domino.pl

www.domino.pl